

Mineral Processing Research  
Institute

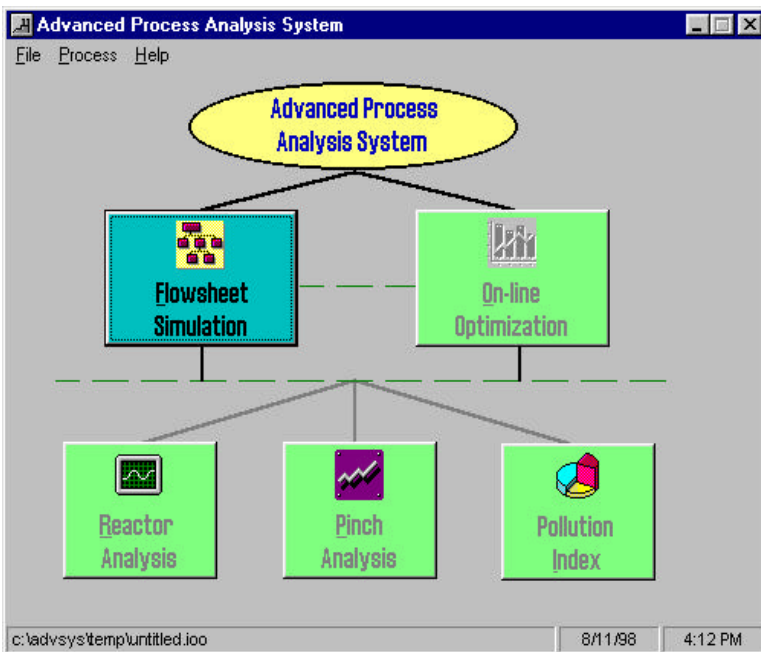
Louisiana State University

**Advanced Process Analysis  
System**  
User's Manual  
and  
Tutorial  
for the Alkylation Process

Derya Ozyurt  
Ralph W. Pike  
Jack R. Hopper  
Janardhana R. Punuru  
Carl L. Yaws

Copyright 2001  
Louisiana State University

May 1, 2001



## TABLE OF CONTENTS

I	Introduction and Methodology.....	1
	A. Flowsheeting.....	1
	A-1. Formulation of Constraints for Process Units.....	3
	A-2. Classification of Variables and Determination of Parameters.....	3
	A-3. Flowsim Interface .....	4
	B. The On-line Optimization Program.....	4
	B-1. Combined Gross Error Detection and Data Reconciliation.....	6
	B-2. Simultaneous Data Reconciliation and Parameter Estimation.....	6
	B-3. Plant Economic Optimization.....	7
	C. The Chemical Reactor Analysis Program.....	7
	D. The Heat Exchanger Network Program.....	9
	E. The Pollution Assessment Program.....	11
	E-1. Waste Reduction Algorithm.....	11
	E-2. The Environmental Impact Theory .....	12
	E-3. Steps in Using the Pollution Assessment Program.....	15
	F. Windows Interface .....	16
	G. Summary.....	17
II	Description of Motiva Alkylolation Process.....	18
III	Process Model for Alkylolation Process .....	25
IV	Getting Started With Advanced Process Analysis System.....	37
V	Using Flowsim.....	37
VI	Using On-line Optimization Program.....	54
VII	Using Heat Exchanger Network Program.....	75
VIII	Using Pollution Assessment Program.....	93
IX	Using Chemical Reactor Analysis Program.....	100
X	Optimization Solver-GAMS .....	101
XI	Acknowledgements .....	117
XII	References.....	118

Appendix A Constraint Equations for Alkylation Acid Process.....	119
Appendix B Full Output File for On-Line Economic Optimization.....	129

## Disclaimer

The Mineral Processing Research Institute(MPRI) makes no warranties, express or implied, including without limitation the implied warranties of merchantability and fitness for particular purpose, regarding the MPRI software. MPRI does not warrant, guarantee or make any representation regarding the use or the results of the use of the MPRI software in terms of its correctness, accuracy, reliability, currentness or otherwise. The entire risk as to the results and performance of the MPRI software is assumed by you.

In no event will MPRI, its director, officers, employees or agents be liable to you for any consequential, incidental or indirect damages (including damage for loss of business profits, business interruption, loss of business information, and the like) arising out of the use or inability to use the MPRI software even if MPRI has been advised of the possibility of such damages.

## I. INTRODUCTION AND METHODOLOGY

An Advanced Process Analysis System is a powerful tool for use by process and plant engineers to perform comprehensive and in-depth evaluations of economic, environmental, safety and hazard analysis projects. This system is based on chemical engineering fundamentals such as stoichiometry, thermodynamics, fluid dynamics, heat transfer, mass transfer, reactor design and optimization. It helps to identify pollutants in chemical processes and petroleum refineries and develop innovative, economically viable designs to eliminate their generation. It aims at waste minimization and pollution prevention in chemical plants, in addition to increased profit and improved efficiency of operations.

The framework of the Advanced Process Analysis System is shown in Figure 1. The main components of this system are an on-line optimization program, a flowsheeting program for process material and energy balances, a chemical reactor analysis program, a heat exchanger network design program, and a pollution assessment module. A Windows interface is used to integrate these programs into one user-friendly application.

The Advanced Process Analysis System methodology to identify and eliminate the causes of energy inefficiency and pollutant generation is based on the onion skin diagram shown in Figure 2. Having an accurate description of the process from on-line optimization, an evaluation of the best types of chemical reactors is done first to modify and improve the process. Then the separation units are evaluated. This is followed by the pinch analysis to determine the best configuration for the heat exchanger network and determine the utilities needed for the process. Not shown in The diagram is the pollution Assessment, which is used to identify and minimize emissions. The following gives a detailed description of the Advanced Process Analysis System and its components, and how they are used together to control and modify the process to maximize the profit and minimize the wastes and emissions. The Motiva Alkylation process will be used to demonstrate the use and capabilities of the Advanced Process Analysis System. This will follow the description of the programs and the components.

### A. Flowsheeting

The first step towards implementing the Advanced Process Analysis System is the development of the process model using Flowsim. As described earlier, process model is a set of constraint equations, which are the material and energy balances, rate equations and equilibrium relations that describe the material and energy transport and the chemical reactions of the process. These form a mathematical model of relationships between the various plant units and process streams. Formulation of the process model can be divided into two important steps.

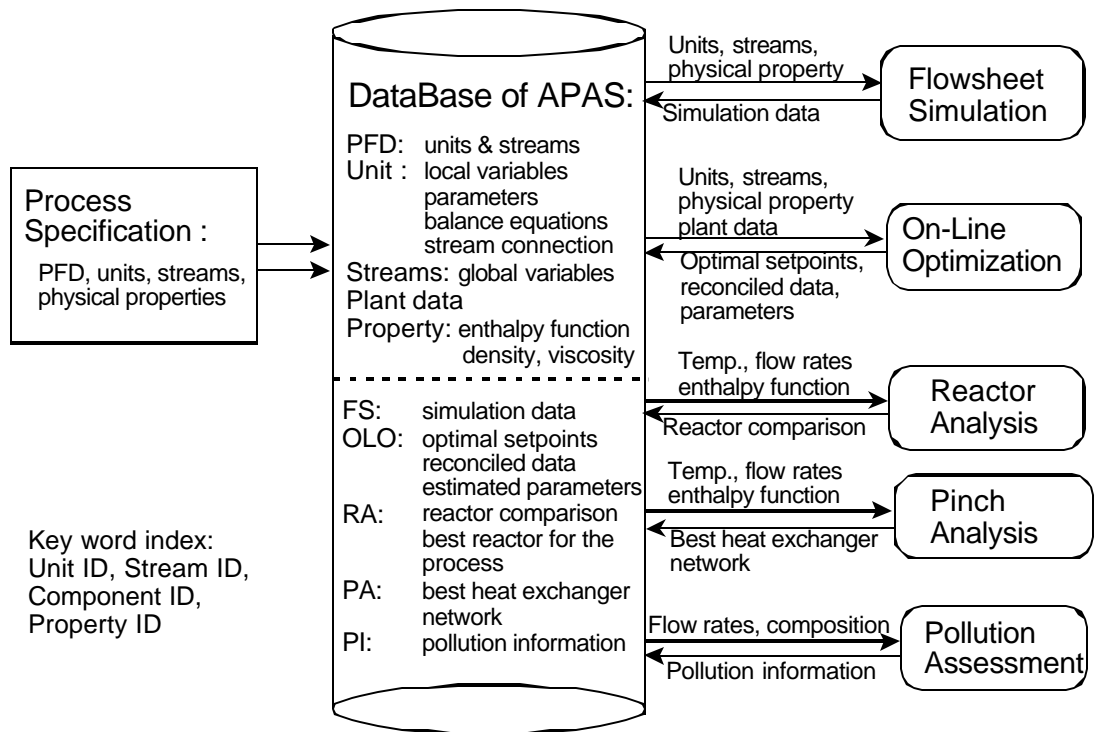
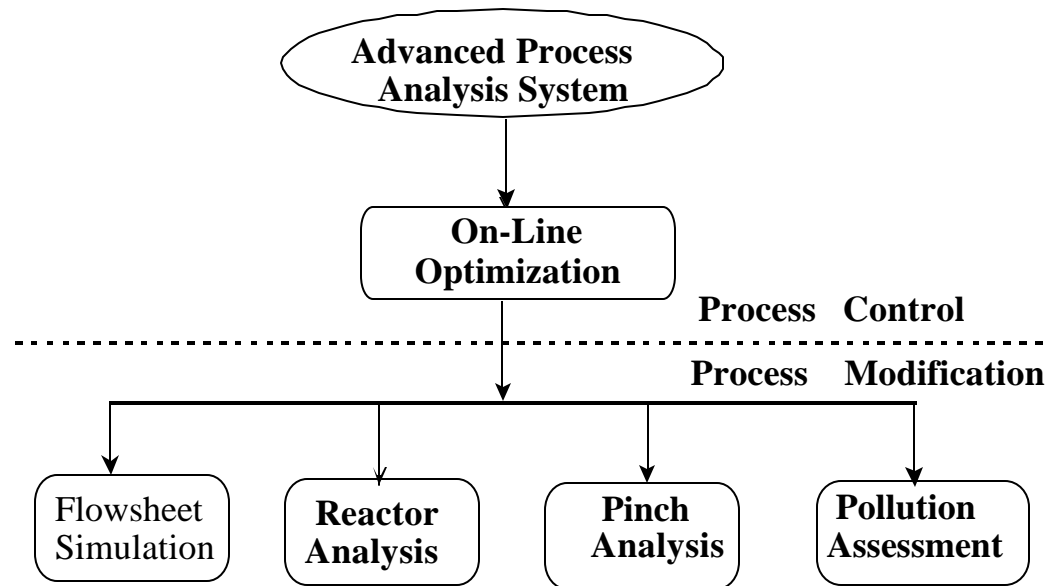


Figure 1: The Framework of the Advanced Process Analysis System

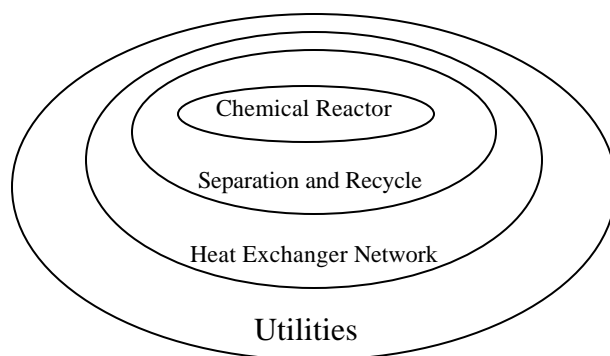


Figure 2: The 'Onion Skin' Diagram for Organization of a Chemical Process and Hierarchy of Analysis.

### **A-1. Formulation of Constraints for Process Units**

The formulation of constraints can be classified into empirical and mechanistic methods. The process models used in Advanced Process Analysis System belong to the type of mechanistic models because they are based on conservation laws as well as the physical and chemical attributes of its constituents.

A typical chemical plant includes hundreds of process units such as heat exchangers, reactors, distillation columns, absorption towers and others. The constraints for these units are either based on conservation laws (mass and energy balances) or they are based on some other laws of nature which include models for chemical phase equilibrium, kinetic models etc. Mathematically, the constraints fall into two types: equality constraints and inequality constraints. Equality constraints deal with the exact relationships such as material and energy balances in the model. The inequality constraints recognize the various bounds involved. Examples of inequality constraints are upper limits on the temperature of certain streams or upper limits on the capacity of certain units.

### **A-2. Classification of Variables and Determination of Parameters**

After the constraints are formulated, the variables in the process are divided into two groups, measured variables and unmeasured variables. The measured variables are the variables which are directly measured from the distributed control systems (DCS) and the plant control laboratory. The remaining variables are the unmeasured variables. For redundancy, there must be more measured variables than the degree of freedom.

The parameters in the model can also be divided into two types. The first type of parameters is the constant parameters, which do not change with time. Examples of these are reaction activation energy, heat exchanger areas etc. The other type of parameters is the time-varying parameters such as catalyst deactivation and heat exchanger fouling factors. These are treated as parameters because they change very slowly with time. They are related to the equipment conditions and not the operating conditions.

### **A-3. Flowsim Interface**

Flowsim is used to develop the process model, and it has a graphical user interface with interactive capabilities. Process units are represented as rectangular shapes whereas the process streams are represented as lines with arrows between these units. Each process unit and stream included in the flowsheet must have a name and a description. Process information is divided into the following six categories; equality constraints, inequality constraints, unmeasured variables, measured variables, parameters and constants.

The information in the first five categories is further classified by associating it with either a unit or a stream in the flowsheet. For example, for a unit that is a heat exchanger, the relevant information includes the mass balance and heat transfer equations, limitations on the flowrates and temperatures if any, the heat transfer coefficient parameter and all the intermediate variables defined for that exchanger.

For a stream, the information includes its temperature, pressure, total flowrate, molar flowrates of individual components etc. Also, information not linked to any one unit or stream is called the 'Global Data'. For example, the overall daily profit of the process is a global unmeasured variable.

The sixth category of constants can be grouped into different sets based on their physical significance. For example, constants related to heat exchangers can be placed in one group and those related to reactors into another group.

Flowsim also has a seventh category of information called as the 'enthalpy coefficients'. This stores the list of all the chemical components in the process and their enthalpy coefficients for multiple temperature ranges. All of this process information is entered with the help of the interactive, user-customized graphic screens of Flowsim. The formulation of process models and the classification of process information for the Alkylation process is given in section II. The next step of Advanced Process Analysis System is on-line optimization.

### **B. The Online Optimization Program**

Once the process model has been developed using Flowsim, the next step is to conduct on-line optimization. On-line optimization is the use of an automated system which adjusts the operation of a plant based on product scheduling and production control to maximize profit and minimize emissions by providing setpoints to the distributed control system. As shown in Figure 3, it includes three important steps: combined gross error detection and data reconciliation, simultaneous data reconciliation and parameter estimation and plant economic optimization. In combined gross error detection and data reconciliation, a set of accurate plant measurements is generated from plant's Distributed Control System (DCS). This set of data is used for estimating the parameters in plant models. Parameter estimation is necessary to have the plant model match the current performance of the plant. Then the economic optimization is conducted to optimize the economic model using this current plant model as constraints and this generates the optimal set points for the Distributed Control System.



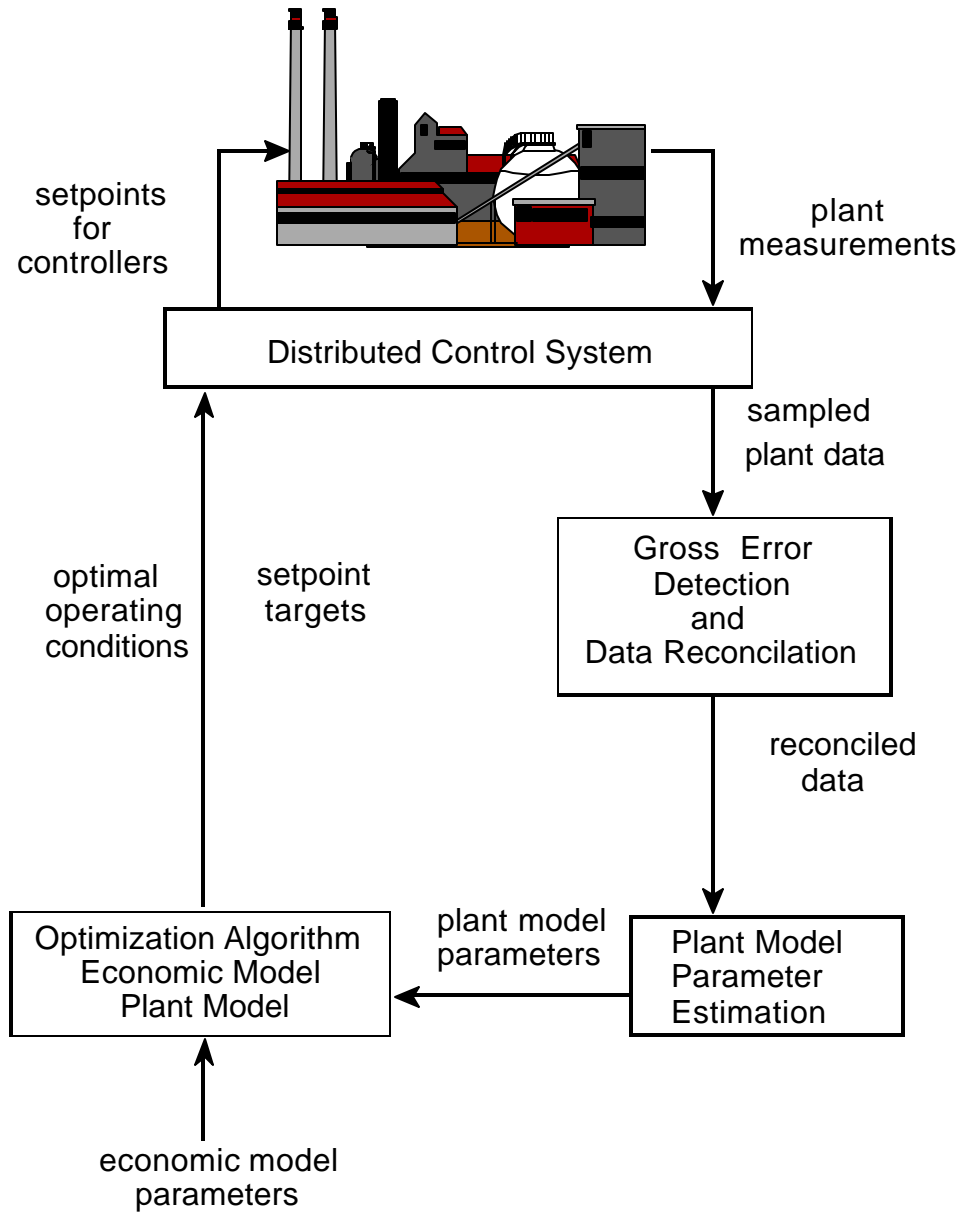


Figure 3: Simplified Structure of Online Optimization

Each of the above three-optimization problems in on-line optimization has a similar mathematical statement as following:

*Optimize:*      *Objective function*  
*Subject to:*    *Constraints from plant model.*

where the objective function is a joint distribution function for data validation or parameter estimation and a profit function (economic model) for plant economic optimization. The constraint equations describe the relationship among variables and parameters in the process, and they are material and energy balances, chemical reaction rates, thermodynamic equilibrium relations, and others.

To perform data reconciliation, there has to be more measurements than necessary to be able to rectify errors in instruments. For redundancy, the number of measurements to determine the unmeasured variables is given by the degree of freedom, which is calculated using the following equation.

$$\text{Degree of freedom} = \text{Total number of variables} - \text{Total number of equality constraints} + \text{Number of chemical reactions}$$

Also, the unmeasured variables have to be determined by the measured variables, called observability. If an unmeasured variable can not be determined by a measured variable, it is unobservable. This is called the 'observability and redundancy criterion', which needs to be satisfied.

### **B-1. Combined Gross Error Detection and Data Reconciliation**

The process data from distributed control system is subject to two types of errors, random error and gross error, and the gross error must be detected and rectified before the data is used to estimate plant parameters. Combined gross error detection and data reconciliation algorithms can be used to detect and rectify the gross errors in measurements for on-line optimization. These algorithms are measurement test method using a normal distribution, Tjoa-Biegler's method using a contaminated Gaussian distribution, and robust statistical method using robust functions. The theoretical performance of these algorithms has been evaluated by Chen, 1998.

Based on Chen's study, the Tjao-Biegler's method is the best for chemical processes and is used to perform combined gross error detection and data reconciliation. When gross errors are in the range of  $-\sigma$  to  $\sigma$ , it detects and rectifies gross errors in plant data sampled from distributed control system. This step generates a set of measurements containing only random errors. Then, this set of measurements is used for simultaneous parameter estimation and data reconciliation using the least squares method. This step provides the reconciled data and the updated parameter values in the plant model for economic optimization. Finally, optimal set points are generated for the distributed control system from the economic optimization using the updated plant and economic models. This optimal procedure can be used for any process to conduct on-line optimization.

### **B-2. Simultaneous Data Reconciliation and Parameter Estimation**

The general methodology for this is similar to the methodology of combined gross error detection and data reconciliation. The difference is that the parameters in plant model are considered as variables along with process variables in simultaneous data reconciliation and

parameter estimation rather than being constants in data reconciliation. Both process variables and parameters are simultaneously estimated. Based on Chen's study, the least squares algorithm is used to carry out the combined gross error detection and data reconciliation. The data set produced by the parameter estimation is free of any gross errors, and the updated values of parameters represent the current state of the process. These parameter values are now used in the economic optimization step.

### **B-3. Plant Economic Optimization**

The objective of plant economic optimization is to generate a set of optimal operating set points for the distributed control system. This set of optimal set points will maximize the plant profit, satisfy the current constraints in plant model, meet the requirements for the demand of the product and availability of raw materials, and meet the restriction on pollutant emission. This optimization can be achieved by maximizing the economic model (objective function) subject to the process constraints. The objective function can be different depending on the goals of the optimization. The objectives can be to maximize plant profit, optimize plant configuration for energy conservation, minimize undesired by-products, minimize the waste/pollutant emission, or a combination of these objectives. The result of the economic optimization is a set of optimal values for all the measured and unmeasured variables in the process. These are then sent to the distributed control system (DCS) to provide set points for the controllers.

The on-line optimization program of the Advanced Process Analysis System retrieves the process model and the flowsheet diagram from Flowsim. Additional information needed to run online optimization includes plant data and standard deviation for measured variables; initial guess values, bounds and scaling factors for both measured and unmeasured variables; and the economic objective function. The program then constructs the three optimization and uses GAMS (General Algebraic Modeling System) to solve them. Results of all three problems can be viewed using the graphical interface of Flowsim.

The Alkylation process will be used to demonstrate the use and capabilities of the on-line optimization program. This is described in Section VI.

### **C. The Chemical Reactor Analysis Program**

Having optimized the process operating conditions for the most current state of the plant, the next step in the Advanced Process Analysis System is to evaluate modifications to improve the process and reduce emission and energy consumption. First, the chemical reactors in the process are examined. The reactors are the key units of chemical plants. The performance of reactors significantly affects the economic and environmental aspects of the plant operation. The formulation of constraints in these types of units is very important and complicated owing to the various types of reactors and the complex reaction kinetics. Unlike a heat exchanger whose constraints are similar regardless of types of equipment, there is a great variation in deriving the constraints for reactors.

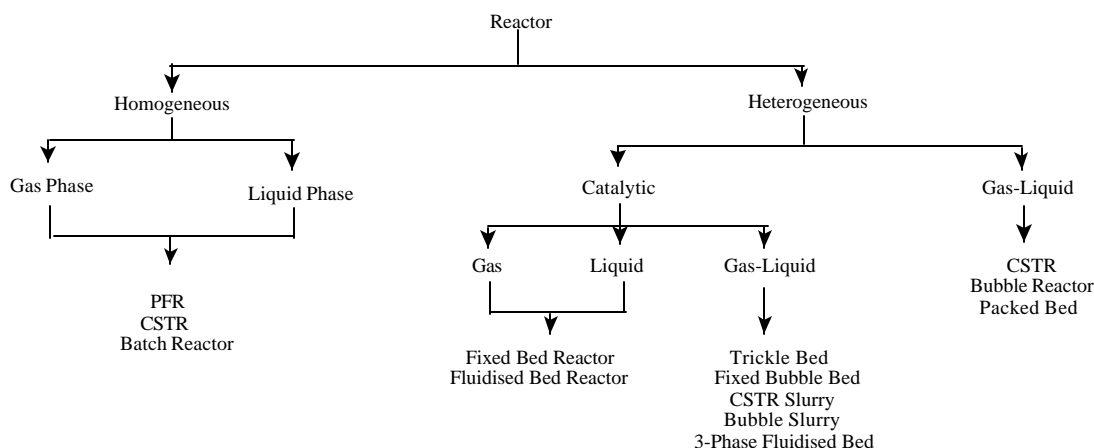


Figure 4: The Reactor Analysis Program Outline

The chemical reactor analysis program of the Advanced Process Analysis System is a comprehensive, interactive computer simulation that can be used for modeling various types of reactors such as Plug Flow, CSTR and Batch reactors. This is shown in Figure 4. Reaction phases included are homogeneous gas, homogeneous liquid, catalytic liquid, gas-liquid etc. The options for energy model include isothermal, adiabatic and non-adiabatic.

The kinetic data needed for the reactor system includes the number of reactions taking place in the reactor and the number of chemical species involved. For each reaction, the stoichiometry and reaction rate expressions also need to be supplied. The physical properties for the chemical species can be retrieved from Flowsim.

The feed stream for the reactor is obtained from Flowsim and its temperature, pressure, flowrate and composition are retrieved using the results from on-line optimization. Finally, the dimensions of the reactor and heat transfer coefficients are supplied. All of this data is used with various types of reactors to predict their performance and select the best one. The reactant concentration, conversion, temperature and pressure are calculated as function of reactor length or space-time. The results can be viewed in both tabular and graphical form.

As the operating process conditions change, the performance of the reactors also can vary to a significant extent. The reactor design program provides a tool to develop an understanding of these relationships. It provides a wide range of different types of reactors, which can be examined and compared to decide the best reactor configuration for economic benefits and waste reduction.

The Alkylation process will be used to demonstrate the use and capabilities of the chemical reactor analysis program. This is described in Section IX.

#### **D. The Heat Exchanger Network Program**

The optimization of the chemical reactors is followed by the heat exchanger network optimization as shown in the onion skin diagram in Figure 2. Most chemical processes require the heating and cooling of certain process streams before they enter another process unit or are released into the environment. This heating or cooling requirement can be satisfied by matching of these streams with one another and by supplying external source of heating or cooling. These external sources are called as utilities, and they add to the operating cost of the plant. The Heat Exchanger Network program aims at minimizing the use of these external utilities by increasing energy recovery within the process. It also synthesizes a heat exchanger network that is feasible and has a low investment cost.

There are several ways of carrying out the above optimization problem. Two of the most important ones are the pinch analysis and the mathematical programming methods. Pinch analysis is based on thermodynamic principles whereas the mathematical methods are based on mass and energy balance constraints. The Heat Exchanger Network Program (abbreviated as THEN) is based on the method of pinch analysis (Knopf, 1989).

The first step in implementation of THEN is the identification of all the process streams, which are important for energy integration. These important streams usually include streams entering or leaving heat exchangers, heaters and coolers. The flowsheeting diagram of Flowsim can be an important aid in selection of these streams.

The next step in this optimization task involves retrieval of the necessary information related to these streams. Data necessary to perform heat exchanger network optimization includes the temperature, the flowrate, the film heat transfer coefficient and the enthalpy data. The enthalpy data can be in the form of constant heat capacities for streams with small temperature variations. For streams with large variations, it can be entered as temperature-dependent enthalpy coefficients. The film heat transfer coefficients are needed only to calculate the areas of heat exchangers in the new network proposed by THEN.

The temperature and flowrates of the various process streams are automatically retrieved from the results of online optimization. The set points obtained after the plant economic optimization are used as the source data. The physical properties such as the heat capacities, enthalpy coefficients and film heat transfer coefficients are retrieved from the Flowsim.

The third step in the heat exchanger network optimization is classification of streams into hot streams and cold streams. A hot stream is a stream that needs to be cooled to a lower temperature whereas a cold stream is a stream that needs to be heated to a higher temperature. Usually, streams entering a cooler or the hot side of a heat exchanger are the hot streams whereas streams entering through a heater or the cold side of a heat exchanger are the cold streams. The final step in this problem requires the specification of the minimum approach temperature. This value is usually based on experience.

Having completed all of the above four steps, the heat exchanger network optimization is now performed using THEN. Thermodynamic principles are applied to determine the minimum amount of external supply of hot and cold utilities. The Composite Curves and the Grand Composite Curve are constructed for the process. These curves show the heat flows at various temperature levels. Illustrations of the composite curves are given in Figure 5. A new network of heat exchangers, heaters and coolers is proposed, which features the minimum amount of external utilities. This network drawn in a graphical format is called the Network Grid Diagram. An example of a network grid diagram is given in Figure 6. Detailed information about the network can be viewed using the interactive features of the user interface.

The amount for minimum hot and cold utilities calculated by the Heat Exchanger Network Program is compared with the existing amount of utilities being used in the process. If the existing amounts are greater than the minimum amounts, the process has potential for reduction in operating cost. The network grid diagram synthesized by THEN can be used to construct a heat exchanger network that achieves the target of minimum utilities. The savings in operating costs are compared with the cost of modification of the existing network, and a decision is made about the implementation of the solution proposed by THEN.

The Alkylation process will be used to demonstrate the use and capabilities of the THEN program. This is described in Section VII.

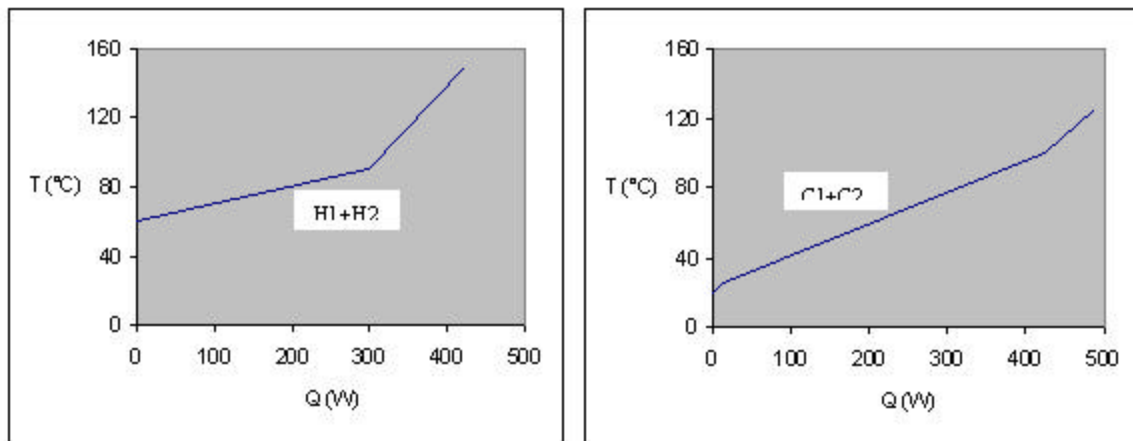


Figure 5: The Composite Curves for Hot Streams (on the left side) and Cold Streams (on the right side) for The Simple Process.

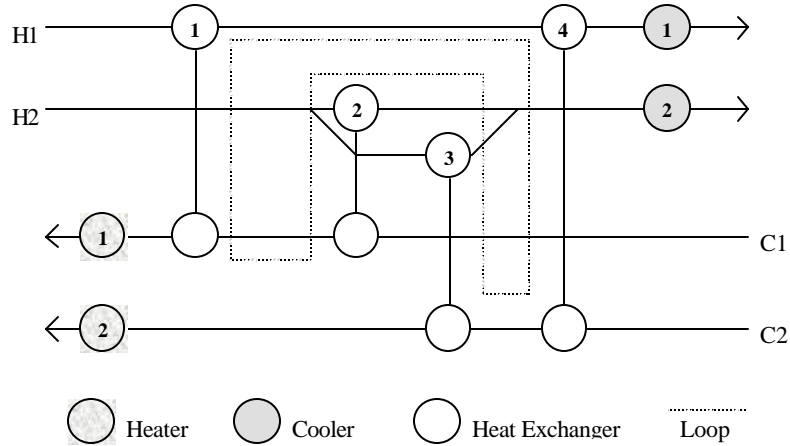


Figure 6: The Grid Diagram

## E. The Pollution Assessment Program

The final step in the Advanced Process Analysis System is the assessment of the pollution impact of the process on the environment. This has become an important issue in the design and optimization of chemical processes because of growing environmental awareness

The pollution assessment module of the Advanced Process Analysis System is called 'The Pollution Assessment Program'. It is based on the Waste Reduction Algorithm (Hilaly, 1994) and the Environmental Impact Theory (Cabezas et. al., 1997).

### E-1. Waste Reduction Algorithm

The WAR algorithm is based on the generic pollution balance of a process flow diagram.

$$\text{Pollution Accumulation} = \text{Pollution Inputs} + \text{Pollution Generation} - \text{Pollution Output}$$

(I.1)

It defines a quantity called as the 'Pollution Index' to measure the waste generation in the process. This pollution index is defined as:

$$I = \text{wastes/products} = - (G_{\text{Out}} + G_{\text{Fugitive}}) / GP_n \quad (\text{I.2})$$

This index is used to identify streams and parts of processes to be modified. Also, it allows comparison of pollution production of different processes. The WAR algorithm can be used to minimize waste in the design of new processes as well as modification of existing processes.

## E-2. The Environmental Impact Theory

The Environmental Impact Theory (Cabezas et. al., 1997) is a generalization of the WAR algorithm. It describes the methodology for evaluating potential environmental impacts, and it can be used in the design and modification of chemical processes. The environmental impacts of a chemical process are generally caused by the energy and material that the process takes from and emits to the environment. The potential environmental impact is a conceptual quantity that can not be measured. But it can be calculated from related measurable quantities.

The generic pollution balance equation of the WAR algorithm is now applied to the conservation of the Potential Environmental Impact in a process. The flow of impact  $\dot{I}$ , in and out of the process is related to mass and energy flows but is not equivalent to them. The conservation equation can be written as

$$\frac{dI_{\text{sys}}}{dt} = \dot{I}_{\text{in}} - \dot{I}_{\text{out}} + \dot{I}_{\text{gen}} \quad (\text{I.3})$$

where  $I_{\text{sys}}$  is the potential environmental impact content inside the process,  $\dot{I}_{\text{in}}$  is the input rate of impact,  $\dot{I}_{\text{out}}$  is the output rate of impact and  $\dot{I}_{\text{gen}}$  is the rate of impact generation inside the process by chemical reactions or other means. At steady state, equation I.3 reduces to

$$0 = \dot{I}_{\text{in}} - \dot{I}_{\text{out}} + \dot{I}_{\text{gen}} \quad (\text{I.4})$$

Application of this equation to chemical processes requires an expression that relates the conceptual impact quantity  $\dot{I}$  to measurable quantities. The input rate of impact can be written as

$$\dot{I}_{\text{in}} = \sum_j \dot{I}_j = \sum_j \dot{M}_j^{\text{in}} \sum_k x_{kj} \Psi_k \quad (\text{I.5})$$

where the subscript 'in' stands for input streams. The sum over j is taken over all the input streams. For each input stream j, a sum is taken over all the chemical species present in that



stream.  $\dot{M}_j$  is the mass flow rate of the stream  $j$  and the  $x_{kj}$  is the mass fraction of chemical  $k$  in that stream.  $Q_k$  is the characteristic potential impact of chemical  $k$ .

The output streams are further divided into two different types: Product and Non-product. All non-product streams are considered as pollutants with positive potential impact and all product streams are considered to have zero potential impact. The output rate of impact can be written as

$$\dot{I}_{out} = \sum_j \dot{I}_j = \sum_j \dot{M}_j^{out} \sum_k x_{kj} \Psi_k \quad (I.6)$$

where the subscript 'out' stands for non-product streams. The sum over  $j$  is taken over all the non-product streams. For each stream  $j$ , a sum is taken over all the chemical species.

Knowing the input and output rate of impact from the equations I.5 and I.6, the generation rate can be calculated using equation I.4. Equations I.5 and I.6 need values of potential environmental impacts of chemical species. The potential environmental impact of a chemical species ( $\Psi_k$ ) is calculated using the following expression

$$\Psi_k = \sum_l a_l \Psi_{k,l}^s \quad (I.7)$$

where the sum is taken over the categories of environmental impact.  $a_l$  is the relative weighting factor for impact of type  $l$  independent of chemical  $k$ .  $Q_{k,l}^s$  is the potential environmental impact of chemical  $k$  for impact of type  $l$ . Values of  $Q_{k,l}^s$  for a number of chemical species can be obtained from the report on environmental life cycle assessment of products (Heijungs, 1992).

There are nine different categories of impact. These can be subdivided into four physical potential impacts (acidification, greenhouse enhancement, ozone depletion and photochemical oxidant formation), three human toxicity effects (air, water and soil) and two ecotoxicity effects (aquatic and terrestrial). The relative weighting factor  $a_l$  allows the above expression for the impact to be customized to specific or local conditions. The suggested procedure is to initially set values of all relative weighting factors to one and then allow the user to vary them according to local needs. More information on impact types and choice of weighting factors can be obtained from the report on environmental life cycle assessment of products (Heijungs, 1992).

To quantitatively describe the pollution impact of a process, the conservation equation is used to define two categories of Impact Indexes. The first category is based on generation of potential impact within the process. These are useful in addressing the questions related to the internal environmental efficiency of the process plant, i.e., the ability of the process to produce desired products while creating a minimum of environmental impact. The second category measures the emission of potential impact by the process. This is a measure of the external

environmental efficiency of the process i.e. the ability to produce the desired products while inflicting on the environment a minimum of impact.

Within each of these categories, three types of indexes are defined which can be used for comparison of different processes. In the first category (generation), the three indexes are as follows.

- 1)  $\dot{I}_{gen}^{NP}$  This measures the the total rate at which the process generates potential environmental impact due to nonproducts. This can be calculated by subtracting the input rate of impact ( $\dot{I}_{in}$ ) from the output rate of impact ( $\dot{I}_{out}$ ).

Total rate of Impact generated based on Potential Environmental Impact is:

$$\dot{I}_{gen}^{NP} = \dot{I}_{out}^{NP} - \dot{I}_{in}^{NP} \quad (I.8)$$

where  $\dot{I}_{in}^{NP}$  is calculated using equation I.5 and  $\dot{I}_{out}^{NP}$  is calculated using Equation I.6.

- 2)  $\hat{I}_{gen}^{NP}$  This measures the potential impact created by all nonproducts in manufacturing a unit mass of all the products. This can be obtained from dividing  $\dot{I}_{gen}^{NP}$  by the rate at which the process outputs products.

Specific Impact generated based on Potential Environmental Impact is:

$$\hat{I}_{gen}^{NP} = \frac{\dot{I}_{gen}^{NP}}{\sum_p \dot{P}_p} = \frac{\dot{I}_{out}^{NP} - \dot{I}_{in}^{NP}}{\sum_p \dot{P}_p} \quad (I.9)$$

where  $\sum_p \dot{P}_p$  is the total rate of output of products

- 3)  $\hat{M}_{gen}^{NP}$  This is a measure of the mass efficiency of the process, i.e., the ratio of mass converted to an undesirable form to mass converted to a desirable form. This can be calculated from  $\hat{I}_{gen}^{NP}$  by assigning a value of 1 to the potential impacts of all non-products.

Rate of Generation of Pollutants per Unit Product is

$$\hat{M}_{gen}^{NP} = \frac{\sum_j \dot{M}_j^{(out)} \sum_k x_{kj}^{NP} - \sum_j \dot{M}_j^{(in)} \sum_k x_{kj}^{NP}}{\sum_p \dot{P}_p} \quad (I.10)$$

The indexes in the second category (emission) are as follows.

- 4)  $\dot{I}_{out}^{NP}$  This measures the the total rate at which the process outputs potential environmental impact due to nonproducts. This is calculated using equation I.6.
- 5)  $\hat{I}_{out}^{NP}$  This measures the potential impact emitted in manufacturing a unit mass of all the products. This is obtained from dividing  $\dot{I}_{out}^{NP}$  by the rate at which the process outputs products.

Specific Impact Emission based on Potential Environmental Impact is:

$$\hat{I}_{out}^{NP} = \frac{\dot{I}_{out}^{NP}}{\sum_p \dot{P}_p} \quad (I.11)$$

- 6)  $\hat{M}_{out}^{NP}$  This is the amount of pollutant mass emitted in manufacturing a unit mass of product. This can be calculated from  $\hat{I}_{out}^{NP}$  by assigning a value of 1 to the potential impacts of all non-products.

Rate of Emission of Pollutants per Unit Product is:

$$\hat{M}_{out}^{NP} = \frac{\sum_j \dot{M}_j^{(out)} \sum_k x_{kj}^{NP}}{\sum_p \dot{P}_p} \quad (I.12)$$

Indices 1 and 4 can be used for comparison of different designs on an absolute basis whereas indices 2, 3, 5 and 6 can be used to compare them independent of the plant size. Higher values of indices mean higher pollution impact and suggest that the plant design is inefficient from environmental safety point of view.

### E-3. Steps in Using the Pollution Index Program

The first step in performing pollution analysis is the selection of relevant streams. Environmental impact of a chemical process is caused by the streams that the process takes from and emits to the environment. Therefore, only these input and output streams are considered in performing the pollution Assessment analysis. Other streams, which are completely internal to the process, are excluded. In the Pollution Index Program, this selection of input-output streams is automatically done based on the plant information entered in Flowsim.

The next step in the pollution index analysis is the classification of the output streams into product and non-product streams. All streams which are either sold as product or which are used up in a subsequent process in the production facility are considered as product streams. All other output streams, which are released into the environment, are considered as non-product streams. All non-product streams are considered as pollutant streams whereas all product streams are considered to have zero environmental impact.

Pollution index of a stream is a function of its composition. The composition data for the streams is retrieved from the results of on-line optimization performed earlier. This can be either in terms of the molar flowrates or fractions. Additional data such as the specific environmental impact potential values for the chemical species is available in the report on environmental life cycle assessment of products.

The last piece of information required is the relative weighting factors for the process plant. These values depend on the location of the plant and its surrounding conditions. For example, the weighting factor for photochemical oxidation is higher in areas that suffer from smog.

Having finished all of the above prerequisite steps, the pollution index program is now called to perform the analysis. Mass balance constraints are solved for the process streams involved, and the equations of the Environmental Impact Theory are used to calculate the pollution index values. The pollution indices of the six types discussed earlier are reported for the process. Three of these are based on internal environmental efficiency whereas the other three are based on external environmental efficiency. Higher the values of these indices, higher is the environmental impact of the process.

The pollution Assessment program also calculates pollution indices for each of the individual process streams. These values help in identification of the streams that contribute more to the overall pollution impact of the process. Suitable process modifications can be done to reduce the pollutant content of these streams.

Every run of on-line optimization for the process is followed by the pollution index calculations. The new pollution index values are compared with the older values. The comparison shows how the change in process conditions affects the environmental impact. Thus, the pollution Assessment program can be used in continuous on-line monitoring of the process.

The Alkylation process will be used to demonstrate the use and capabilities of the pollution Assessment program. This is described in section VIII.

## **F. Windows Interface**

An important part of the advanced process analysis system is development of the Graphical User Interface (GUI). It was necessary to have a programming language, which could integrate all of above applications into one program. It should also be able to exchange information between these programs without the intervention of the process engineer.

There are four competitive object-oriented, rapid applications development tools with GUI windows that have the above capabilities. These are Microsoft's Visual Basic, Borland's Delphi32, IBM's Visual Age and Powersoft's Powerbuilder.

We have chosen Visual Basic as the interface development language. It is integrated with Windows 95 and Windows NT, has a low cost and can link applications over a local area network. Also, Visual Basic supports the Object Linking and Embedding technology in OLE2. This feature allows the programs to exchange information regardless of the physical or logical location or data type and format.

Visual Basic 5.0 was used to develop windows interface for Flowsim, the on-line optimization program, the chemical reactor design program, THEN, the heat exchanger network design program, and the pollution Assessment program. As mentioned earlier, sharing of process, economic and environmental data is the key to integration of these programs into one package. Storing the output data of all these programs in different files had many disadvantages. Both storage and retrieval of data would be inefficient. Also, exchange of information between the programs would require reading data from a number of files thus reducing the speed.

As a result, it was decided to use a database to store all of the necessary information to be shared by the component programs as shown in Figure 1. A database is nothing but a collection of information in form of tables. The information in a table is related to a particular subject or purpose. A number of database formats are in use in industry. We have chosen Microsoft Access as the database system for this project.

A table in Microsoft Access consists of rows and columns, which are called *Records* and *Fields* respectively in the database terminology. Each *Field* can store information of a particular kind e.g. a table 'Stream Data' can have a field called 'Temperature' which stores all the stream temperatures. Another table can have a field called 'Prices' which has the prices of all the reactants and products. Each *Record* is a data entry, which fills all the fields of a table. So, the Stream Data table in the above example can have a record for stream S1, which has values for temperatures, pressure, flowrates etc. entered in the respective fields.

Microsoft Access is an interactive database system. Using Access, you can store data in tables according to the subject. This makes tracking of data very efficient. Also, you can specify relationships between different tables. Consequently, it is easy to bring together information related to various topics. Microsoft Access takes full advantage of the graphical power of windows. Also, it is fully compatible with Microsoft's Visual Basic and Microsoft Excel, which is a significant advantage for this application.

## **G. Summary**

The Advanced Process Analysis System offers a combination of powerful process design and modification tools. The Visual Basic interface integrates all of these into one system and makes the application very user-friendly. The best way to understand the application of the Advanced Process Analysis System is apply it to an actual process. The Alkylation process is

used for this purpose. This process incorporates four reactor pairs and four acid settlers. The next section gives a detailed description of the Alkylation process.

## II. DESCRIPTION OF ALKYLATION PROCESS

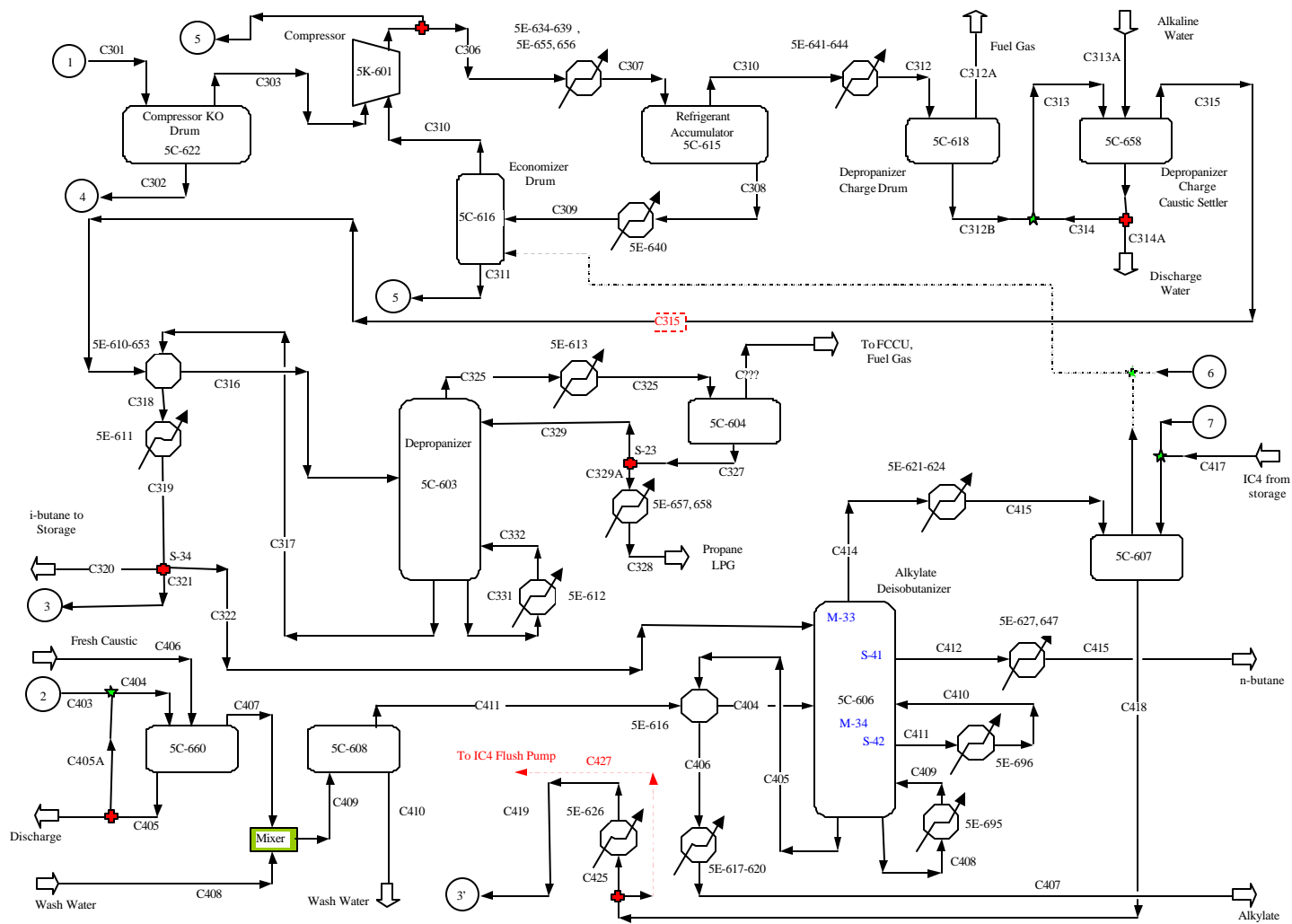
Motiva Alkylation process plant is a 15,000 BPD STRATCO Effluent Refrigerated Alkylation Plant. The heart of the process is the STRATCO reactor or contactor, which contacts the reactants in a high velocity propeller stream and removes heat from the exothermic reaction.

In the STRATCO Effluent Refrigerated Alkylation process, light olefins (propylene, butylenes) are reacted with isobutane in the presence of sulfuric acid catalyst to form hydrocarbon, mainly in the  $iC_7$  to  $iC_8$  range, called alkylate. The alkylate product is a mixture of gasoline boiling range branched hydrocarbons which is blended with the refinery gasoline pool to increase the gasoline octane.

Process flow diagrams representing Motiva alkylation process are shown in Figures 7, 8 and 9. These were prepared from P&ID's of the plant. The reaction section of the process is shown in Figure 7. The refrigeration, depropanizer and deisobutanizer sections are shown in Figure 8. The saturate deisobutanizer section of the alkylation process is shown in Figure 9.

The process has four reactor pairs and four acid settlers as shown in Figure 7. In the reaction section there are three feed streams, the olefin feed (HC01), the isobutane feed (HC03) and the recycled olefin/isobutane mixture (HC32). The olefin feed contains the light olefins that are reacted with isobutane in the alkylation unit's STRATCO stirred reactors. The isobutane stream is in excess to fully react with all of the olefins being charged to the unit. The process units are described in this section.

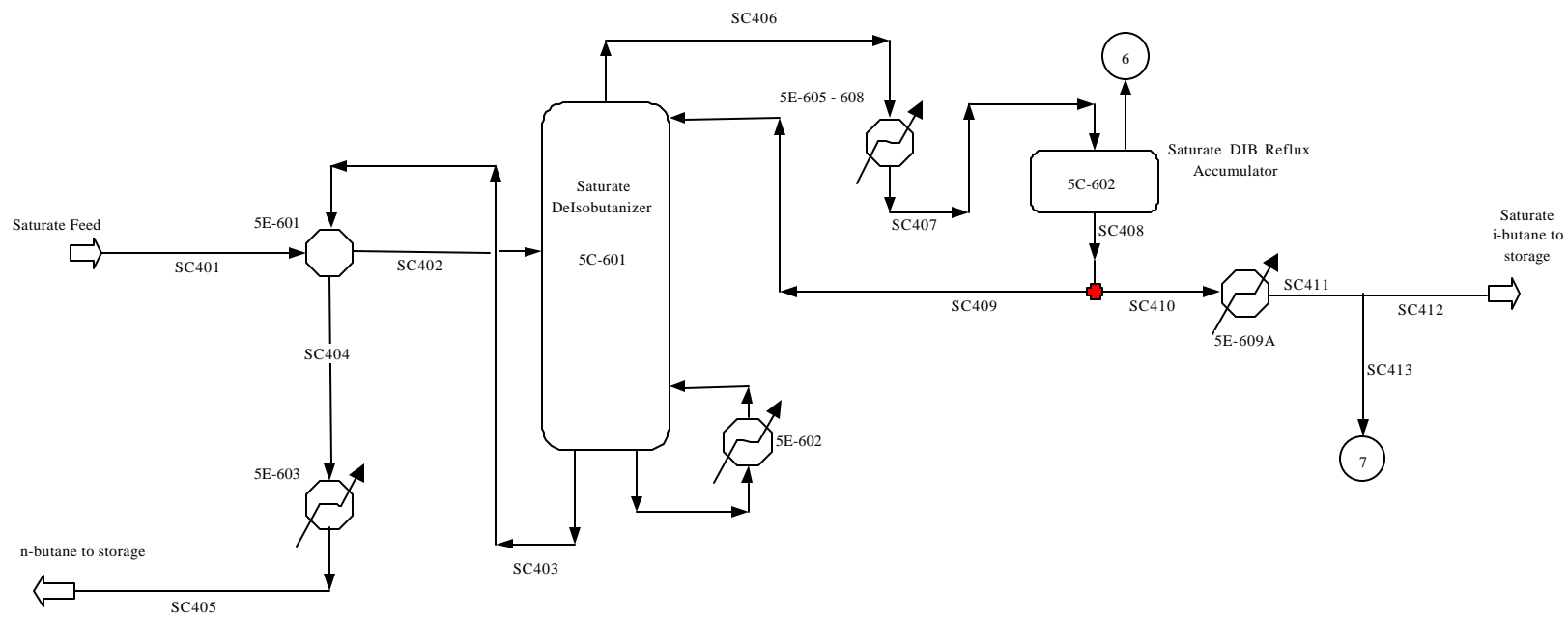




**Figure 8. Refrigeration, Depropanizer and Deisobutanizer sections of the Alkylation process**





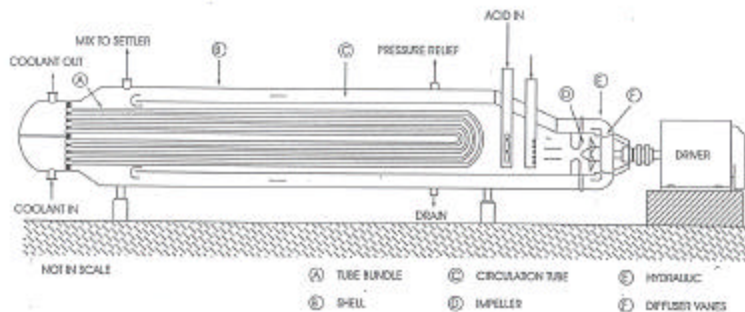


**Figure 9. Saturate Deisobutanizer Section of the Alkylation Process**

## A. STRATCO Contactor

The two feed streams (HC01 and HC03) are cooled by exchanging heat with the net Contactor effluent stream (5E-628, 5E-628, 5E-630) from the suction trap/flash drum (5C-614) as shown in Figure 7. The two streams are then combined and fed to the STRATCO Contactors (5C-623 to 5C-630). The recycled olefin/isobutane stream is fed to the Contactors separately (HC34, HC38, HC41, HC45).

The STRATCO Contactor, in which the alkylation reaction occurs, is a horizontal pressure vessel containing a mixing impeller, an inner circulation tube and a tube bundle to remove the heat generated by the alkylation reaction as shown in Figure 10. The feed is injected into the suction side of the impeller inside the circulation tube. The impeller rapidly disperses the hydrocarbon feed with acid catalyst to form an emulsion. The emulsion is circulated by the impeller at high rates within the Contactor. The sulfuric acid present within the reaction zone serves as a catalyst to the alkylation reaction. The acid absorbs a small amount of hydrocarbon from side reactions and feed contaminants which reduces the sulfuric acid concentration. In order to maintain the desired spent acid strength (89.0 wt%  $\text{H}_2\text{SO}_4$ ) in the last two of the eight Contactors, fresh acid (98.5 wt%  $\text{H}_2\text{SO}_4$ ) is continuously charged to the first two Contactors, and an equivalent amount of 89.0 wt% spent acid is withdrawn from the acid settler.



**Figure 10. STRATCO Effluent Refrigeration Reactor (Yongkeat, 1996)**

The hydrocarbon and acid are separated in four settlers 5C-631 to 5C-634 and the acid-free hydrocarbon phase (HC22, HC23, HC25, HC27) flows from the top of the acid settler through a backpressure control valve. Part of it goes into the tube side of the contactor tube bundle (R1). The backpressure control valve is set at a pressure (60.0 psig) to maintain the contents of the settler in the liquid phase. As the hydrocarbon stream passes through the control valve, its pressure is reduced to about 5.0 psig, flashing a portion of the stream's lighter components, thereby, cooling the stream to a temperature of about 30 °F. When the two-phase stream passes through the tube bundle, additional vapor is generated as a result of absorbing heat generated by the alkylation reaction.

## **B. Refrigeration Section**

As shown in Figure 7, the second portion (HC29) of the hydrocarbon effluent from the settler goes to the isobutane chiller (5E-633) and is used to reduce the temperature of the isobutane feed stream. It then combines with the Contactor effluent stream leaving the tube bundle and flows into the suction trap side of the suction trap/flash drum (5C-614), where the liquid and vapor portions of this stream are separated. The suction trap/flash drum is a two-compartment vessel with a common vapor space. The net Contactor effluent is accumulated on one side of a separation baffle and is pumped to the effluent treating section. The cold refrigerant condensate is accumulated on the other side of the baffle. This effluent recycle stream consists mostly of isobutane and is returned to the Contactor by the effluent recycle pump. The vapor portions of both of these streams combine and flow to the suction of the refrigeration compressor (5K-601) shown in Figure 8.

The compressor driven by an electric motor, increases the pressure of the refrigerant vapor to allow condensing by cooling water. The vapor is condensed in two steps to provide a higher concentration of propane in the depropanizer feed.

Liquid generated by the first bank of condensers (e.g. 5E-634-639) is separated from the propane-rich vapor in the refrigerant accumulator (5C-615), further cooled by the refrigerant cooler, and then flashed across a control valve. Vapor and liquid are separated in an economizer (5C-616). The economizer vapor returns to an intermediate stage of the compressor (5K-601) to be recompressed, while the liquid is returned to the suction trap/flash drum (5C-614).

The remaining vapor portion of the compressor discharge stream (C310) flows from the separator to the "total condenser" (5E-641-644). Liquid from the total condenser is accumulated in the Depropanizer Charge Drum (5C-618), and ultimately fed to the Depropanizer (5C-603) for stripping of propane before being sent to the Alkylate Deisobutanizer (5C-606).

## **C. Depropanizer (5C-603)**

The depropanizer feed stream is pumped from the charge drum to the depropanizer feed caustic wash (5C-658) to neutralize acidic components. The neutralized stream then flows to the depropanizer feed/bottoms exchanger (5E-610-5E-653) before entering the tower, as shown in Figure 8.

The overhead propane vapor from the depropanizer (C325) is totally condensed by cooling water and collected in the depropanizer reflux accumulator drum (5C-604). A part of the liquid is refluxed to the column's top tray (C329), and the rest is further cooled and sent to the LPG section (C328). The

depropanizer bottoms product (C317) temperature is reduced in the feed/bottoms exchanger (5E610-653). The stream then enters a water-cooled exchanger (5E-611) before it is split into three portions, one each for the Alkylate Deisobutanizer, the Contactor (3) and storage.

#### **D. Alkylate Deisobutanizer (5C-606)**

The net effluent from the suction trap/flash drum (5C-614) is heated in the feed/effluent exchangers (5E-628; 5E-629, 5E-630) as shown in Figure 7 and then treated with caustic to remove any traces of acid (5C-660 and 5C-608 in Figure 8). The treated net effluent is fed to the alkylate deisobutanizer (DIB) tower (5C-606) to strip isobutane from alkylate as shown in Figure 8. Two steam-fired thermosiphon reboilers (5E-695, 5E-696) supply the majority of the heat to the lower portion of the column by vaporizing liquid side draws (C411) from the column as well as the DIB bottoms liquid (C408). A portion of the depropanizer bottoms is fed to the column as the reflux (C322).

Normal butane is removed as a vapor side-draw (C412). The vapor is condensed and cooled by cooling water (5E-627, 5E-647). The normal butane product (C415) can be used for vapor pressure blending or sold. The rate of the normal butane product will vary depending on the desired deisobutanizer alkylate product Reid Vapor Pressure (RVP).

The overhead isobutane vapor is condensed by cooling water and accumulated in the isobutane accumulator pot (5C-607). Make-up isobutane (C417) from storage is added to the pot and the combined stream (C418) is sent to the Contactors to react with the olefins (3).

The deisobutanizer bottoms (C405) is the alkylate product. It is cooled by the deisobutanizer feed/effluent exchanger (5E-616) and also a heat exchanger with cooling water (5E-617-5E-620). The cooled alkylate (C407) is removed as a product and sent to storage.

#### **E. Saturate Deisobutanizer (5C-601)**

Another source for isobutane is the saturate deisobutanizer (SatDIB) column (Figure 9), which strips isobutane from saturate feed coming from reformer unit of the refinery (SC401). The saturate feed, containing mainly C<sub>4</sub>'s, flows to the SatDIB feed/bottoms exchanger (5E-601) before entering the tower, as shown in Figure 8. The overhead isobutane vapor is condensed by cooling water and a fraction of it (stream SC413) is accumulated in the isobutane accumulator pot (5C-607, Figure 8). The saturate deisobutanizer bottoms (SC403) are mainly n-butane product. It is cooled by the SatDIB feed/bottoms exchanger (5E-601) and also by a heat exchanger with cooling water (5E-603). The cooled n-butane (SC405) is sent to storage.

### III. PROCESS MODEL FOR ALKYLATION PROCESS

A process model of a chemical engineering process is a set of constraint equations, which represents a mathematical model of relationships between the various plant units and process streams. Before the constraint equations are formulated, it is important to note that in order to have an accurate model of the process, it is essential to include the key process units such as reactors, heat exchangers and absorbers. These units affect the economic and pollution performance of the process to a significant extent. Certain other units are not so important and can be excluded from the model without compromising the accuracy. For the Alkylation process, The equipment in the Alkylation plant can be categorized according to their functions as Reaction Zone, Separation Zone, Heat Transfer Zone, Miscellaneous.

#### Reaction Zone:

- STRATCO Contactor
- Acid settler

#### Separation Zone:

- Depropanizer
- Alkylate Deisobutanizer
- Saturate Deisobutanizer
- Suction Trap Flash Drum
- Economizer
- Compressor

#### Heat Transfer Zone:

- Heat Exchangers
- Condensers
- Reboilers

#### Miscellaneous:

- Mixers
- Splitters
- Reflux Accumulators

The alkylation process involves mixtures of a variety of components. The components and compositions of streams vary widely from one section to the other. For record keeping, all the hydrocarbon streams in the plant are composed of the following components:

1.  $C_3$ - Propane and lower
2.  $C_4$ = Butenes
3.  $iC_4$  iso-butane
4.  $nC_4$  normal-butane

5.  $iC_5$         iso-pentane
6.  $nC_5$         normal-pentane
7.  $iC_6$         iso-hexane
8.  $iC_7$         iso-heptane
9.  $iC_8$         iso-octane
10.  $iC_{9+}$       iso-nonane and higher

All the sulfuric acid streams in the plant are composed of:

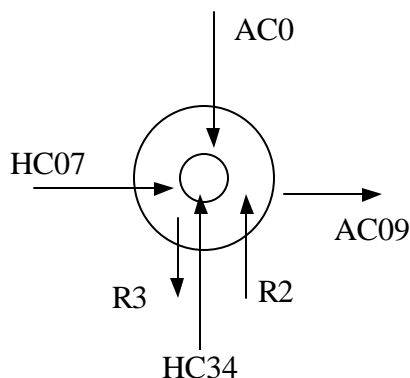
11.  $H_2SO_4$     sulfuric acid
12. Water and impurities

The streams carrying the reaction products from the contactors to the acid settlers contain all of the twelve components.

### A. STRATCO Contactor (5C-623)

The sulfuric acid alkylation reaction mechanism for pure propylene and pure butylene feeds is based on the Schmering carbonium ion mechanism with modification introduced to account for  $iC_9$  and  $iC_{10}$  formation. The parameters that affect the performance of the contactor are:

1. Operating Temperature
2. Acid Strength
3. Isobutane Concentration
4. Olefin Space Velocity



**Figure 11: Contactor 5C-623**

The contactor was modeled as of a Continuously Stirred Tank Reactor (CSTR) with heat exchange. The intense mixing provided by the propellers ensures that there is no spatial variation in concentration, temperature, or reaction rate throughout the vessel. The composition and temperature of the exit stream were the same as those inside the reactor.

Referring to Figures 7 and 11, the material and energy balance equations for the contactor 5C-623 are as follows:

## Description

Inlet streams: HC07 (isobutane- olefin mixture), HC34 (effluent recycle-mainly isobutane), and AC07 (sulfuric acid catalyst)  
Outlet streams: AC09  
Coolant streams: R2 (in), R3 (out)

## Material Balance

Overall:

$$\text{Mass flowrate in} - \text{Mass flowrate out} = 0 \quad (\text{III.1})$$

$$F_{HC07} + F_{HC34} + F_{AC07} - F_{AC09} = 0 \quad (\text{III.2})$$

$$F_{R2} - F_{R3} = 0 \quad (\text{III.3})$$

where,  $F_X$  is the total mass flow rate (metric ton/min) of stream X.

Component:

$$\text{Mass flowrate in} - \text{Mass flowrate out} + \text{Mass generation rate} = 0 \quad (\text{III.4})$$

$$F_{HC07}^i + F_{HC34}^i - F_{AC09}^i + r^i V_{5C623}^a MW^i = 0 \quad (\text{III.5})$$

for the hydrocarbon components. Here,  $r^i$  is the reaction rate of component i, in terms of moles of i produced per unit time, per unit volume of the acid catalyst (metric ton moles/(m<sup>3</sup>·min)), and  $MW^i$  is the molecular weight of component i. The quantity  $V_{5C623}^a$ , shown in the material balance equations, is the volume of acid in the contactor, and is typically 60 % of the total contactor volume.

Considering the degradation of the catalyst, the material balance equation for the acid component can be written as

$$F_{AC07}^i - F_{AC09}^i - R_{5C623}^a = 0 \quad (\text{III.6})$$

where,  $R_{5C623}^a$  is the rate of degradation of the acid (metric ton/min). The acid degradation rate can be related to the volumetric flowrate of butylenes into the contactor as follows (Graves 1999),

$$R_{5C623}^a = 0.121 Q_{HC07}^{C4=} \quad (\text{III.7})$$

The total mass flow rates are calculated as the sum of the component flow rates.

$$\sum F_X^i - F_X = 0 \quad (\text{III.8})$$

The subscripts to the process variables like mass flow rates, specific enthalpies and stream temperatures indicate the stream names, and their superscripts indicate the component. The subscripts to the process parameters indicate the process unit they represent.



The material in the contactor is a two-phase mixture, consisting of a hydrocarbon phase and an acid phase. Since the reaction model assumes that all the reactions occur in the acid phase, the concentrations shown in the reaction model equations are those in the acid phase.

The olefin feed to the process is composed of about 45% 1v butylenes (1-BUT + C2B + T2B) and about 3.5% 1v propylene among other paraffins. Because of the low presence of propylene and the non-participation of paraffins in the alkylation reaction, the reaction mechanism of alkylation of isobutane with pure butylene was adopted. The reaction rate terms in Equation III.5 is evaluated.

Alkylation of isobutane with olefins is an exothermic reaction. The reaction mixture must be maintained in a particular temperature range (0-10 °C) in order to obtain the desired yields. Higher operating temperatures result in oxidation and polymerization reactions, decreasing the yields. Lower temperatures result in decreased effectiveness due to the increase in acid viscosity and decrease in solubility of hydrocarbons in the acid phase. Therefore, the temperature in the contactor is maintained by recycling the cold refrigerant condensate from the Suction Trap Flash Drum, which consists mostly of isobutane, and by circulating a part of the flashed, acid-free effluent from the settlers, through the contactor tube bundle. When the two-phase stream passes through the tube bundle, additional vapor is generated.

The tube bundle in the contactor, is effectively, a partial boiler, which vaporizes a portion of the coolant. This can be modeled by assuming that the two-phases in the coolant mixture are in equilibrium with each other throughout the tube bundle. The component mass balance for the two-phase coolant stream can be written as

$$(F_{R2l}^i + F_{R2v}^i) - (F_{R3l}^i + F_{R3v}^i) = 0 \quad (\text{III.9})$$

$$K_i = \frac{y_i}{x_i} \quad \text{where,} \quad \sum x_i = 1, \quad \sum y_i = 1 \quad (\text{III.10})$$

In the above equation,  $y_i$  is the mole fraction of component i in the vapor phase, and  $x_i$  is that in the liquid phase.

The model can be simplified by assuming that all the vapor generation in the tube bundle, due to transfer of heat from the contactor, occurs at a point outside the tube bundle; i.e. after the coolant has passed through it. This is the same as considering the partial boiler to be equivalent to a heater followed by an isothermal flash operation. Then, the mole fractions can be written as

$$y_i = \frac{F_{R3v}^i / MW^i}{\sum F_{R3v}^i / MW^i} \quad \text{and} \quad x_i = \frac{F_{R3l}^i / MW^i}{\sum F_{R3l}^i / MW^i} \quad (\text{III.11})$$

### Energy Balance

Overall:

$$\text{Energy in} + \text{Energy generated} - \text{Energy out} = 0 \quad (\text{III.12})$$

$$h_{HC07} + h_{HC34} + h_{AC07} + h_{R2} + H_{5C623} - h_{AC09} - h_{R3} = 0 \quad (\text{III.13})$$

where,  $h_X$  is the enthalpy of stream X in (MJ/min), and  $H_{5C623}$  is the heat generated in the contactor by the exothermic reaction (MJ/min).

The stream enthalpies are calculated from the component specific enthalpies, as

$$h_X = \sum F_X^i h_X^i \text{ for single phase streams, and} \quad (\text{III.14})$$

$$h_X = \left( \sum F_X^i h_X^i \right)_l + \left( \sum F_X^i h_X^i \right)_v \quad (\text{III.15})$$

for two-phase streams (R2 and R3)

where,  $h_X^i$  is the specific enthalpy of the component i in stream X in (MJ/metric ton).

Heat Transfer:

$$\text{Energy in} - \text{Energy out} - \text{Energy transferred out} = 0 \quad (\text{III.16})$$

$$h_{R2} - h_{R3} - U_{5C623} A_{5C623} \Delta T_{lm} = 0 \quad (\text{III.17})$$

where,  $U_{5C623}$  is the overall heat transfer coefficient (MJ/m<sup>2</sup>·°C·min),  $A_{5C623}$  is the area of heat transfer (m<sup>2</sup>), and  $\Delta T_{lm}$  is the log mean temperature difference in the contactor 5C-623 (°C).

$$\Delta T_{lm} = \frac{(T_{5C623} - T_{R2}) - (T_{5C623} - T_{R3})}{\ln \frac{(T_{5C623} - T_{R2})}{(T_{5C623} - T_{R3})}} \quad (\text{III.18})$$

The mass and energy balance equations for contactor 5C-623 are summarized in Table A.1 in Appendix A.

## E. Acid Settler (5C-631)

The acid settler separates the emulsion from the contactor into the acid and hydrocarbon phases. One acid settler is provided to each pair of contactors. The inputs to the settler are the effluents from the contactor pair and the outputs are the separated acid and hydrocarbon streams.

The material and energy balance equations for the acid settler (5C-631) are as shown in Table A.2 Appendix A. The mass flow rate of each component coming in is equal to the mass flow rate of each component leaving of the settler. Since there is no heat transferred from or into the settler, the temperatures of the various input and output streams can be assumed to be equal. We also assume that the separation of the two phases in the settler is complete, so that there is no acid component in the output hydrocarbon stream and vice-versa.

## C Depropanizer (5C-603)

The Depropanizer was modeled using Smith-Brinkley Group method (Smith, 1963; Perry *et al.*, 1984). This method can be applied to absorption, extraction processes and distillation. The equation, which applies to the distillation process is, for each component  $i$ ,

$$f = \frac{(1 + S_{n,i}^{N-M}) + R(1 - S_n)}{(1 + S_{n,i}^{N-M}) + R(1 - S_n) + hS_n^{N-M}(1 - S_m^{M+1})} \quad (\text{III.19})$$

where  $R$  is the external-reflux ratio  $F_{C329}/F_{C328}$  and  $f = (F_{C317}^i/F_{C316}^i)$ , is the fraction of  $i$  leaving in the bottoms product. The quantity  $S$  is the stripping factor (for each component) and is defined for each group of stages in the column by  $S_{n,i} = K_i V/L$  and  $S_{m,i} = K'_i V'/L'$ .  $K$  is the equilibrium ratio  $y/x$  for each component and  $V$ ,  $L$  are the vapor and liquid molar flow rates in the column. The  $K_i$ ,  $V$  and  $L$  values are the effective values for the top column section;  $K'_i$ ,  $V'$  and  $L'$  are the effective values for the section below the feed stage. The quantity  $h$  depends on whether  $K$  or  $K'$  is used for the feed stage. If the feed is mostly liquid, the feed stage is grouped with the lower stages and

$$h_i = \frac{K'_i L}{K_i L'} \left( \frac{1 - S_n}{1 - S_m} \right)_i \quad (\text{III.20})$$

If the feed is mostly vapor,

$$h_i = \frac{L}{L'} \left( \frac{1 - S_n}{1 - S_m} \right)_i \quad (\text{III.21})$$

The following four specifications for the column are necessary:

1.  $N$ , the total number of equilibrium stages
2.  $M$ , the number of stages below the feed stage
3. The reflux rate or the maximum vapor rate at some point in the column
4. The distillate rate  $D$

Specification of D and L (or V), along with specifications of the feed stream variables fixes the assumed phase rates in both sections of the column. Determination of separation factors  $S_n$  and  $S_m$  then depends upon estimation of individual K values. If ideal solutions are assumed, K values are functions of only temperature and column specified pressure. Estimation of K values and, in turn,  $S_n$  and  $S_m$  values for each component reduces to estimation of the effective temperature in each column section or group of stages.

The effective temperature is assumed to be the arithmetic average for simplicity.

$$T_n = (T_N + T_{M+1}) / 2 \quad (\text{III.22})$$

$$T_m = (T_{M+1} + T_1) / 2 \quad (\text{III.23})$$

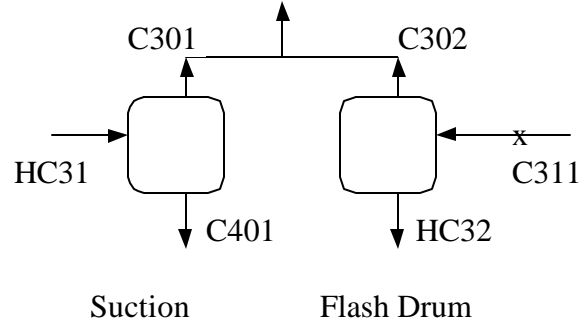
The feed enters the column at the (M+1)th stage. The material and energy balance equations for the depropanizer are shown in Table A. in 3 Appendix A. The Saturate Deisobutanizer column is modeled in a similar way.

#### **D. Alkylate Deisobutanizer (5C-606)**

The alkylate deisobutanizer column has two feed streams, two product streams, two side streams and two reboilers, one of which is used as a side reboiler. One of the feed streams is fed to the column, at the top tray, in place of the reflux. There was no readily available short cut method to model such a distillation column as it is, therefore, the column was divided into three reasonable sections (C-606A, C-606C and C-606D) which can be modeled using Smith Brinkley Method and by employing equilibrium stage assumption. General Smith-Brinkley Method is used for a classical distillation column with recycle and reboiler streams, however the model of deisobutanizer requires the derivation of the Method for the rectifying and stripping sections separately. Derivations can be found in (Smith, 1963) – Design of Equilibrium Stage Processes in Table A.4 in Appendix A.

## F. Suction Trap/Flash Drum (5C-614)

The suction trap/flash drum (STFD) splits the hydrocarbon effluent from the settlers based on volatility. It is a two-compartment vessel, with a common vapor space. The net contactor effluent is accumulated on one side of the baffle and the cold refrigerant condensate on the other. The vapors from the two compartments combine, and flow out from the top.



**Figure 12: STFD 5C-614**

The STFD is modeled as two separate units – suction trap and flash drum, with the vapor streams from the two units combining in a mixer, as shown in Figure 12. The suction trap acts as the separating vessel for the two-phase contactor from the contactor tube bundles and from the isobutane chiller (5E-633). The liquid and vapor streams leave the vessel as two separate streams. In the Flash drum, the cold condensate from the economizer is flashed and separated. This unit is modeled as an equilibrium stage with adiabatic flash. The material and energy balance equations for the two units are as follows:

### Suction Trap:

$$\text{Overall material balance: } (F_{HC31l} + F_{HC31v}) - (F_{C401} + F_{C301}) = 0 \quad (\text{III.24})$$

$$F_{HC31l} - F_{C401} = 0 \quad (\text{III.25})$$

$$\text{Component material balance: } (F_{HC31l}^i + F_{HC31v}^i) - (F_{C401}^i + F_{C301}^i) = 0 \quad (\text{III.26})$$

$$F_{HC31l}^i - F_{C401}^i = 0 \quad (\text{III.27})$$

$$\text{Energy balance: } T_{HC31} = T_{C301} = T_{C401} \quad (\text{III.28})$$

### Flash Drum

$$\text{Overall material balance: } F_{C311} - F_{HC32} - F_{C302} = 0 \quad (\text{III.29})$$

$$\text{Component material balance: } F_{C311}^i - F_{HC32}^i - F_{C302}^i = 0 \quad (\text{III.30})$$

$$K_i = \frac{y_i}{x_i}, \text{ where, } \sum x_i = 1, \sum y_i = 1 \quad (\text{III.31})$$

$$\text{Energy balance: } h_{C311} - h_{HC32} - h_{C302} = 0 \quad (\text{III.32})$$

The flash operation has been described, in detail, in the contactor modeling section. The Suction Trap Flash Drum model described above is summarized in Table A.5 in Appendix A.

### F. Economizer (5C-616)

The Economizer separates the vapor and liquid phases generated when the liquid portion of the propane-rich vapor, in the Depropanizer section, is flashed. This unit is modeled the same way as the flash drum of STFD, i.e. assuming an adiabatic flash operation, where the two phases generated are in equilibrium with each other. The mass and enthalpy balances are:

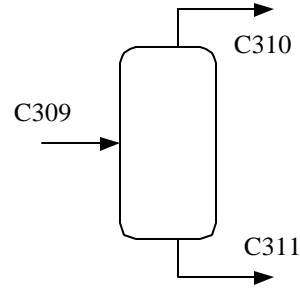


Figure 13. Economizer 5C-616

Overall material balance:

$$F_{C309} - F_{C310} - F_{C311} = 0 \quad (\text{III.33})$$

Component material balance:

$$F_{C309}^i - F_{C310}^i - F_{C311}^i = 0 \quad (\text{III.34})$$

$$K_i = \frac{y_i}{x_i}, \text{ where, } \sum x_i = 1, \sum y_i = 1 \quad (\text{III.35})$$

In the above equation,  $K_i$  is the distribution coefficient or the K-factor,  $y_i$  is the mole fraction of component i in the vapor phase, and  $x_i$  is that in the liquid phase.

Enthalpy balance:

$$h_{C309} - h_{C310} - h_{C311} = 0 \quad (4.36)$$

where,  $h_x$  is the enthalpy of stream X.

## G Compressor (5K-601)

The combined vapor stream from Suction Trap and the Flash Drum is rich in propane, and is sent to the depropanizer section. The vapor is compressed in the Refrigeration compressor (5K-601), to allow condensing by cooling water. The compressor was assumed to operate under adiabatic conditions, and hence the calculations were based on the following formulas (Perry *et al.*, 1984):

Adiabatic head is expressed as

$$H_{ad} = \frac{k}{k-1} RT_1 \left[ \left( \frac{p_2}{p_1} \right)^{\frac{(k-1)}{k}} - 1 \right] \quad (\text{III.37})$$

where  $H_{ad}$  = adiabatic head, ft;  $R$  = gas constant, (ft·lbf)/(lb·°R) = 1545/molecular weight;  $T_1$  = inlet gas temperature, °R;  $p_1$  = absolute inlet pressure, lbf/in<sup>2</sup>;

$p_2$  = Absolute discharge pressure, lbf/in<sup>2</sup>,  $k$  = ratio of specific heat capacities ( $c_p/c_v$ ).

The work expended on the gas during compression is equal to the product of the adiabatic head and the weight of the gas handled. Therefore, the adiabatic power is as follows:

$$hp_{ad} = \frac{WH_{ad}}{550} = \frac{k}{k-1} \frac{WRT_1}{550} \left[ \left( \frac{p_2}{p_1} \right)^{\frac{(k-1)}{k}} - 1 \right] \quad (\text{III.38})$$

or

$$hp_{ad} = 4.36 \times 10^{-3} \frac{k}{k-1} Q_1 p_1 \left[ \left( \frac{p_2}{p_1} \right)^{\frac{(k-1)}{k}} - 1 \right] \quad (\text{III.39})$$

where  $hp_{ad}$  = power, hp;  $W$  = mass flow, lb/s; and  $Q_1$  = volume rate of gas flow, ft<sup>3</sup>/min.

Adiabatic discharge temperature is:

$$T_2 = T_1 \left( \frac{p_2}{p_1} \right)^{\frac{(k-1)}{k}} \quad (\text{III.40})$$

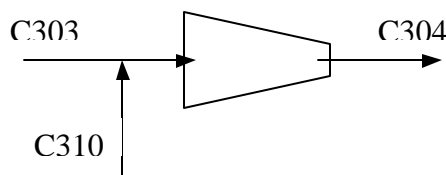


Figure 14: Compressor 5K-601

The constraint equations, for the compressor, are developed using the above formulas.  
Overall material balance:

$$F_{C303} + F_{C310} - F_{C304} = 0 \quad (\text{III.41})$$

Component material balance:

$$F_{C303}^i + F_{C310}^i - F_{C304}^i = 0 \quad (\text{III.42})$$

Enthalpy balance:

$$h_{C303} + h_{C310} + hp_{ad} - h_{C304} = 0 \quad (\text{III.43})$$

$$T_2 = T_1 \left( \frac{p_2}{p_1} \right)^{\frac{(k-1)}{k}} \quad (\text{III.44})$$

where  $hp_{ad}$  is the compressor as given in Equations (III.38, III.39). The constraints of the compressor are summarized in Table A.7 in Appendix A.

## H. Olefin Feed Effluent Exchanger (5E-628)

The olefin feed effluent exchanger cools the olefin feed by exchanging heat with the alkylate effluent stream from the suction trap/flash drum. The material and energy balance equations for this exchanger are shown in Table A.8 in Appendix A. Since no mass transfer is involved in this unit, the masses of the two streams are conserved. The heat transferred between the streams can be accounted for as shown in the energy balance equations.

This concludes the description of the main units in the Alkylation. The following describes the validation of the alkylation process model.

## Model Validation

The validation of the above described model by solving the data validation problem using a set of plant data (steady state operation point #1) and then comparing the results of the model with the plant data. The model predicted out of the 125 plant variables 88 within the accuracy of the measurements. The remaining 37 variables (Table III.1), especially FC316, FC322, x5C417, xx5C412, xx7C414 are found within the range of possible process values. The discrepancy in the variable xx1C322 can be accounted by the model assumption that the propane purge from the drum 5C-618 occurs infrequently.



Table III.1. Plant vs. Model Data

Variable Name	Plant Data	Reconciled Data From Data Validation	Gross Error
FAC02	0.1125	0.1600	4.2235
FAC12	0.1259	0.1600	2.7085
FAC23	0.1253	0.1600	2.7653
FAC45	0.1040	0.1600	5.3846
FC308	2.1990	3.1032	4.1120
FC316	0.6581	1.8000	17.3515
FC322	0.4427	1.5619	25.2812
FC328	0.0942	0.0535	2.6399
FC403	3.8766	2.2834	4.1097
FC412	0.0324	0.0418	2.8968
FSC411	2.7287	1.3525	5.0436
FstmE612	0.1425	0.0889	3.7607
x1C417	0.0372	0.0255	3.1309
x2SC402	0.0136	0.0084	3.7929
x2SC408	0.0221	0.0002	9.9048
x3C325	0.0017	0.0000	10.0000
x3SC403	0.0103	0.0212	10.5665
x4C316	0.0580	0.0796	3.7155
x4SC408	0.0331	0.0088	7.3475
x5C316	0.0020	0.0060	19.8000
x5C417	0.0009	0.0295	286.2300
x5HC32	0.0096	0.0306	22.0134
x6SC402	0.0167	0.0666	29.8204
x6SC403	0.0250	0.0950	27.9946
x7HC32	0.0197	0.0497	15.2312
x7SC402	0.0022	0.0032	4.3956
x7SC408	0.0022	0.0000	10.0000
xx1C322	0.0027	0.1167	428.5338
xx1C414	0.0330	0.0800	14.2498
xx2HC01	0.4525	0.1291	7.1481
xx3C407	0.0003	0.0000	7.4194
xx3HC01	0.3558	0.0125	9.6498
xx4C407	0.1124	0.0853	2.4068
xx5C407	0.0803	0.1506	8.7555
xx5C412	0.0022	0.0581	255.6751
xx5C414	0.0021	0.0011	4.8325
xx7C414	0.0015	0.0080	44.4218

#### **IV. GETTING STARTED WITH THE ADVANCED PROCESS ANALYSIS SYSTEM**

Upon running the Advanced Process Analysis System, the first window presented to the user is the 'Advanced Process Analysis Desk'. This is shown in Figure 15.

By default, the Advanced Process Analysis System opens a new model named 'untitled.ioo' in the program directory. The complete filename for this new model is shown in the bottom left corner of the window. The bottom right corner shows the date and the time the program was started. The file menu provides various options such as opening a new or an existing model. This is shown in Figure 16. The 'Recent Models' item in the file menu maintains a list of last four recently used models for easy access.

The Advanced Process Analysis Desk has five buttons leading to the five component programs, which were described in earlier sections. All of these can also be called using the process menu at the top. This is shown in Figure 17.

When a new model is opened, only the 'Flowsheet Simulation' button is available. This is because the development of the process model using Flowsim is the first step in the implementation of the Advanced Process Analysis System. Until the flowsheet simulation part is completed, buttons for the other four programs remain dimmed and unavailable.

To implement the Advanced Process Analysis System for the Motiva Alkylation process described in earlier section, the first step is to develop the process model using the Flowsim program. The 'Flowsheet Simulation' button should be now clicked to open the Flowsim program.

#### **V. USING FLOWSIM**

Upon clicking the 'Flowsheet Simulation' button in Figure 17, the Flowsim window is displayed with the 'General Information' box. In the space for model name, let us enter 'Alkyl'. In the process description box, let us enter 'Alkylation Process'. The 'General Information' box with this information is shown in Figure 18.

On clicking the 'OK' button, the main screen of 'Flowsim' is displayed. This is the screen where the user draws the flowsheet diagram. The 'Model' menu shown in Figure 19 provides the various commands used to draw the flowsheet diagram. The menu commands are divided into two groups. The first group has commands for drawing the flowsheet diagram whereas the second group has commands for entering various kinds of process information.

The 'Add Unit' command should be used to draw a process unit. The 'Add Stream' command should be used to draw a process stream between two process units. The program requires that every stream be drawn between two units. However, the input and output streams of a process only have one unit associated with them. To solve this problem, the Flowsim program provides an additional type of unit called 'Environment I/O'. This can be drawn using the command 'Add Environment I/O' in Figure 19. The 'Lock' option makes the diagram read-only and does not allow any changes. The diagram can be unlocked by clicking on the command again.

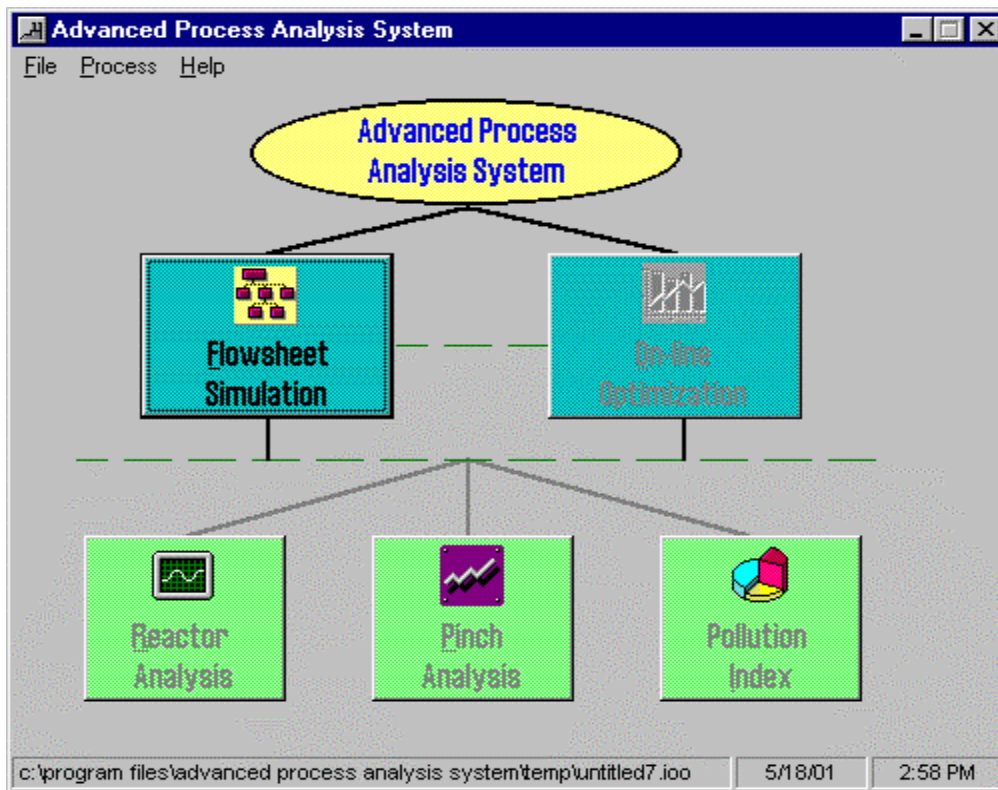


Figure 15. Advanced Process Analysis Desk

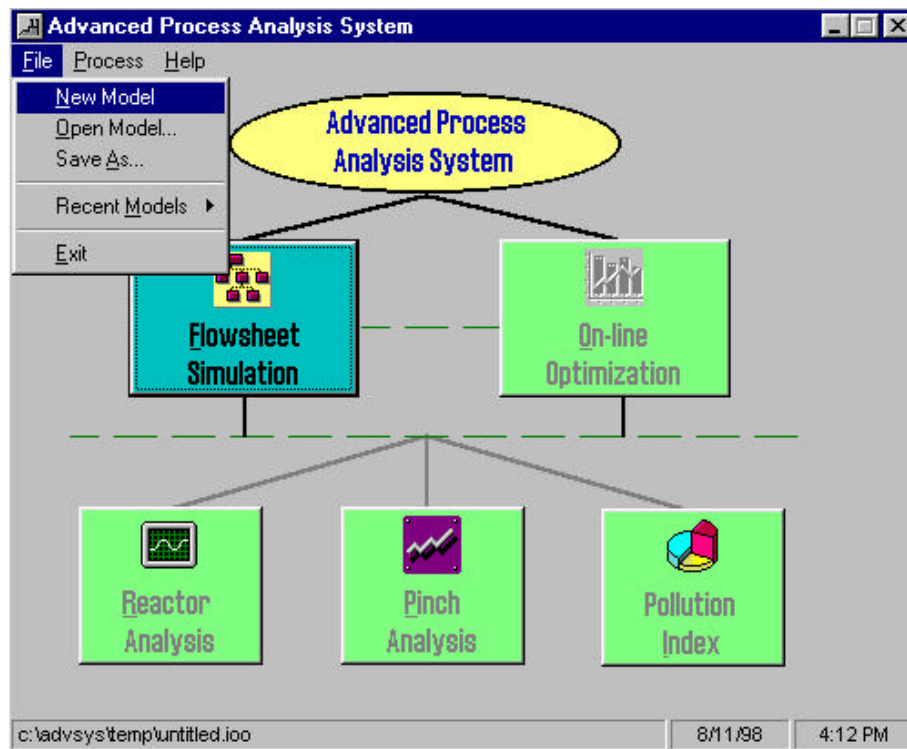


Figure 16. The File Menu of the Advanced Process Analysis Desk

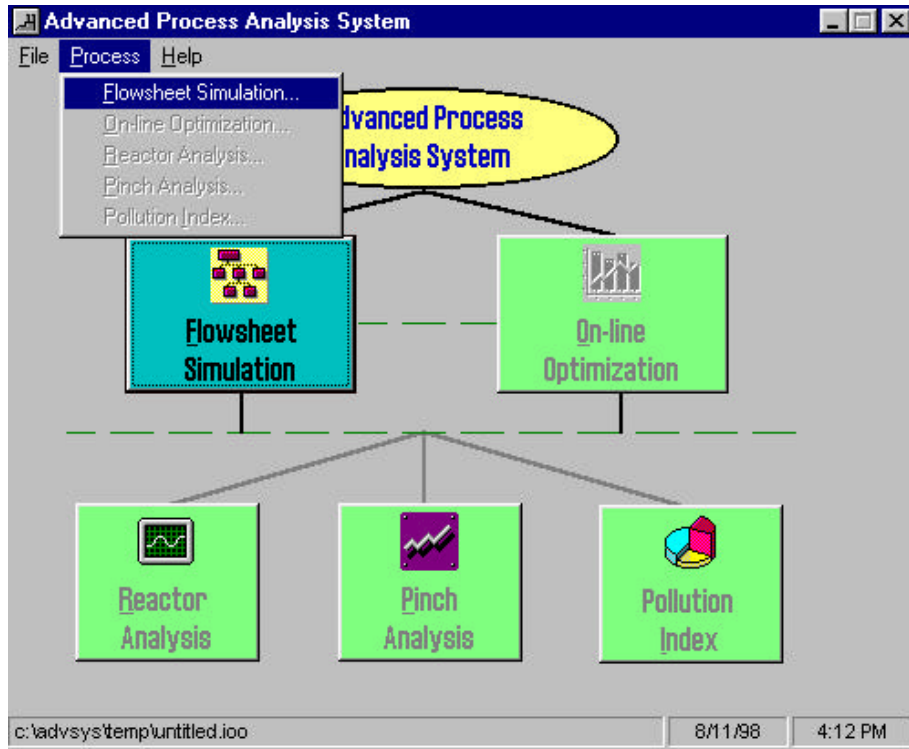


Figure 17. The Process Menu of the Advanced Process Analysis Desk

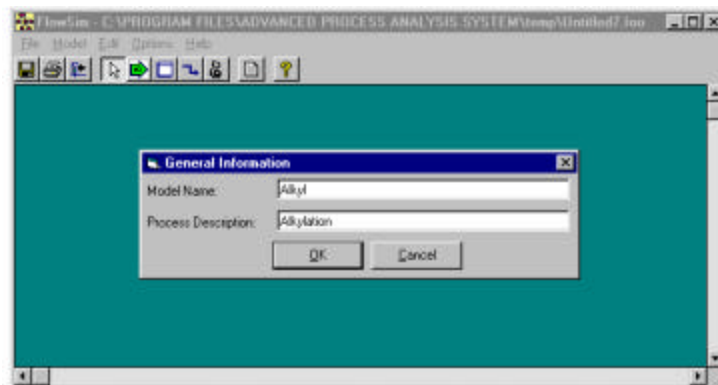


Figure 18. General Information Box

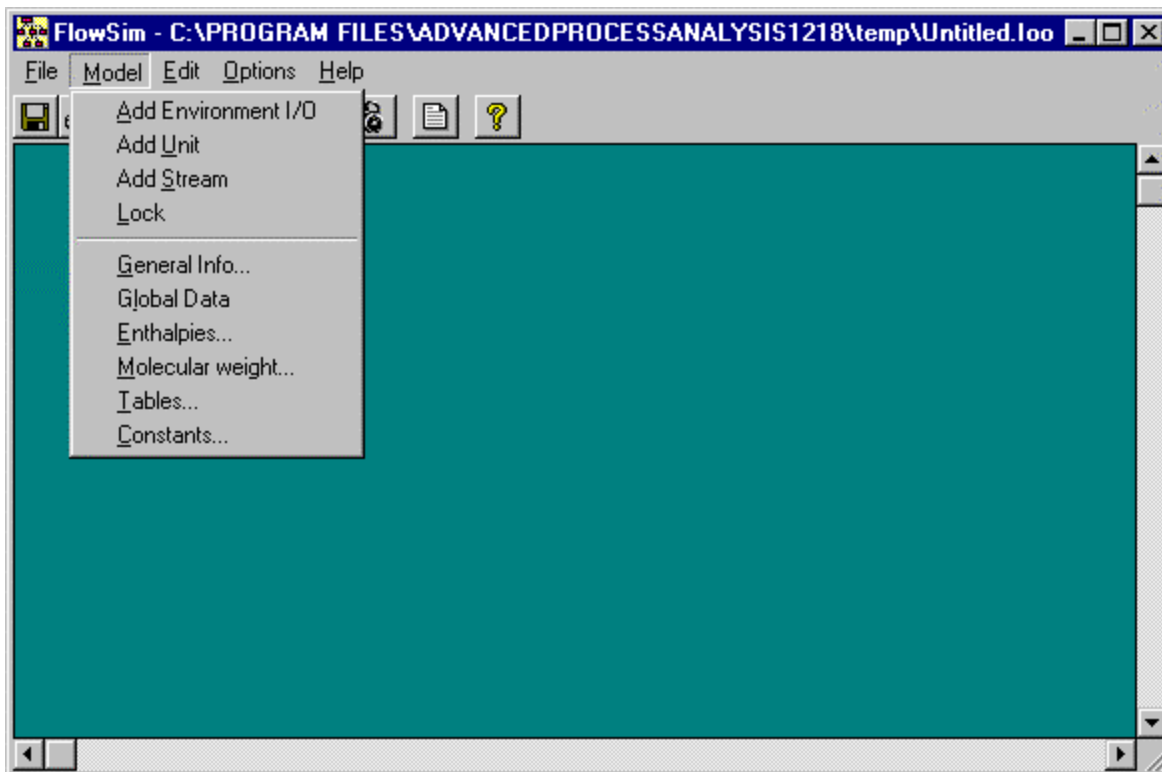


Figure 19. The Model Menu

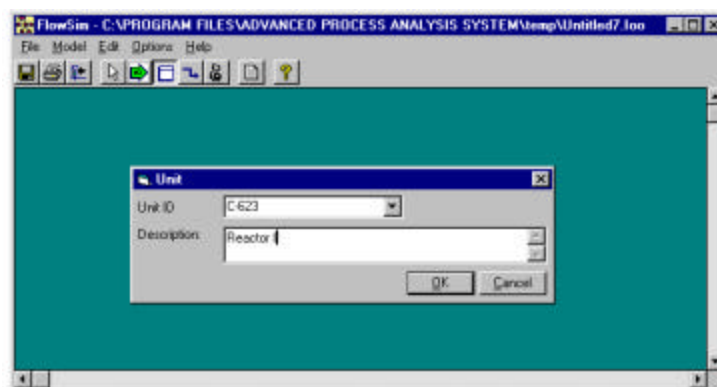


Figure 20. The Unit Window

Now, let us use these commands to draw the flowsheet diagram for the Motiva Alkylation process. Although Flowsim allows the units and streams to be drawn in any order, it is recommended that while drawing a process model, one should start with the feed and then add units and streams in order. Let us draw the Unit C-623 (Reactor I) which is one of the main reactors of the process. Select the 'Add Unit' command from the 'Model' menu. The mouse cursor changes to a hand. The cursor can now be dragged to draw a rectangle.

Once, the mouse button is released, a small input window appears on the screen as shown in Figure 20. For every process unit that is drawn in Flowsim, the user is required to enter a unique Unit ID and description. For the Reactor I, let us enter 'C-623' as the unit ID and 'Reactor I' as the description.

Now, let us draw the another Unit in the flowsheet diagram. Let us enter the Unit ID '5C-631' and description 'Settler I'. With these two units, the screen looks like in Figure 21.

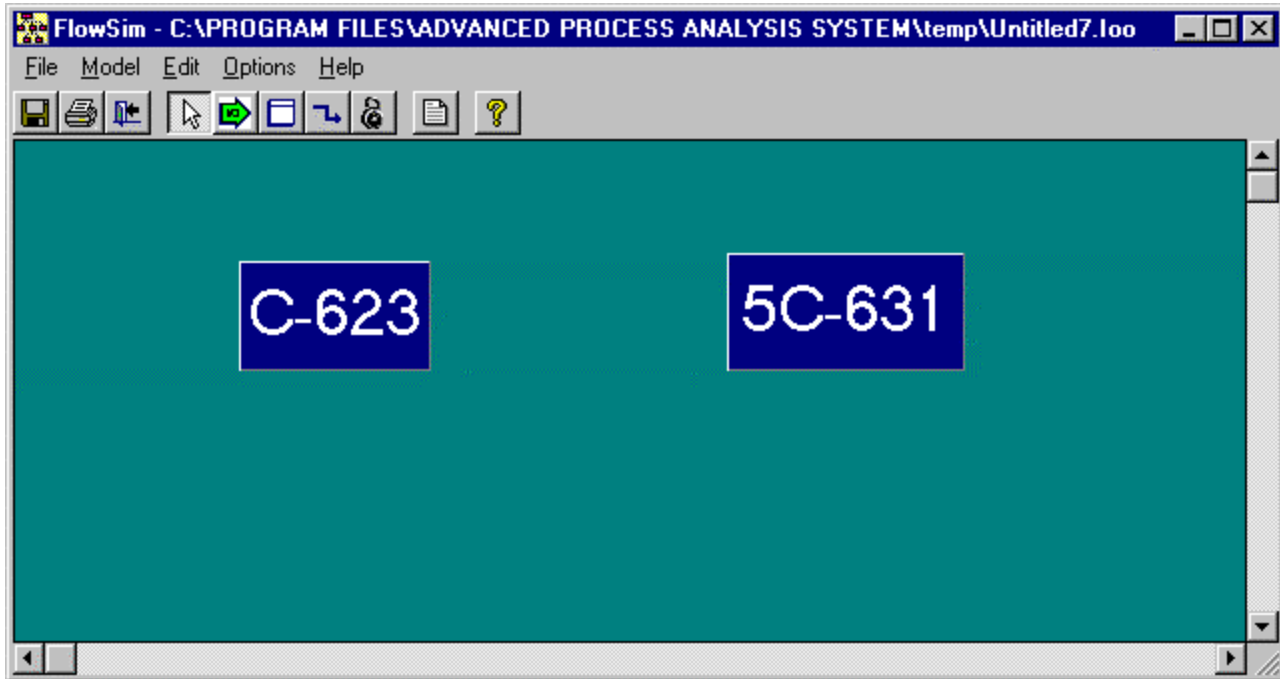


Figure 21 . Flowsheet Screen with two Units

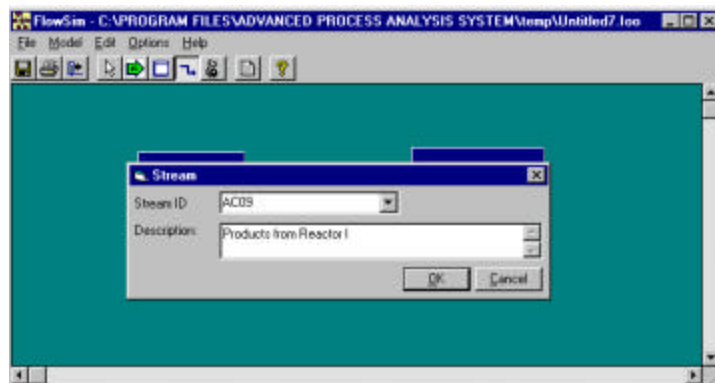


Figure 22. The Stream Window

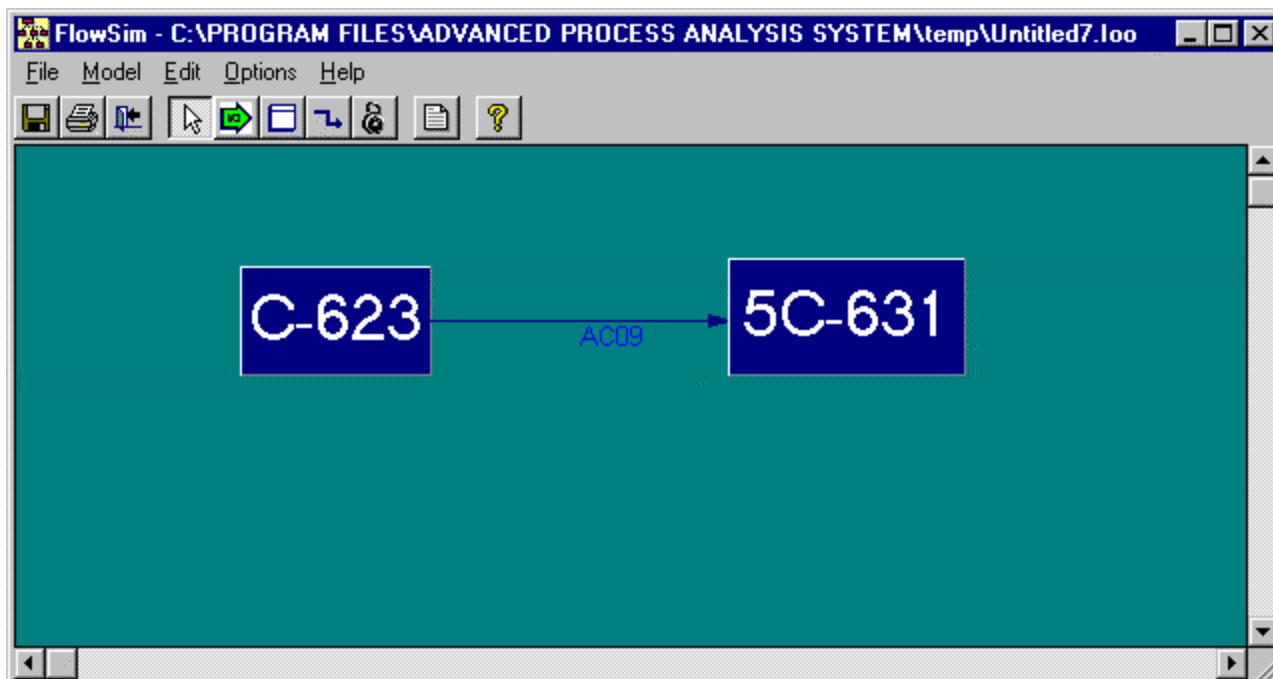


Figure 23. Flowsim Screen with two Units and a Stream

Now, let us add the stream that leaves the unit C-623 and enters the unit 5C-631. To do this, select the 'Add stream' command from the 'Model' menu. The cursor changes to a small circle. Position the cursor on the unit C-623 and drag the cursor to the unit 5C-631. The program now displays a small box shown in Figure 22. Let us enter the stream ID 'AC09' and the description 'Products from Reactor I' With the S-2, M-3 and HC28 stream, the Flowsim screen looks as shown in Figure 23. In this way, the entire process flow diagram for the Alkylation process can be drawn using the Model menu commands. After drawing the complete diagram, the Flowsim screen looks as shown in Figure 24.

The 'Edit' menu at the top of the Flowsim screen provides various options for editing the diagram. It is shown in Figure 25. To use the Edit commands, a unit in the flowsheet diagram has to be selected first by clicking on it. The cut, copy and paste commands can be used for both units as well as streams. The 'Delete' command can be used to permanently remove a unit or a stream from the diagram. The 'Rename' command can be used to change the unit ID for a unit or to change the stream ID for a stream. The 'Properties' command can be used to change the appearance of a unit or a stream.

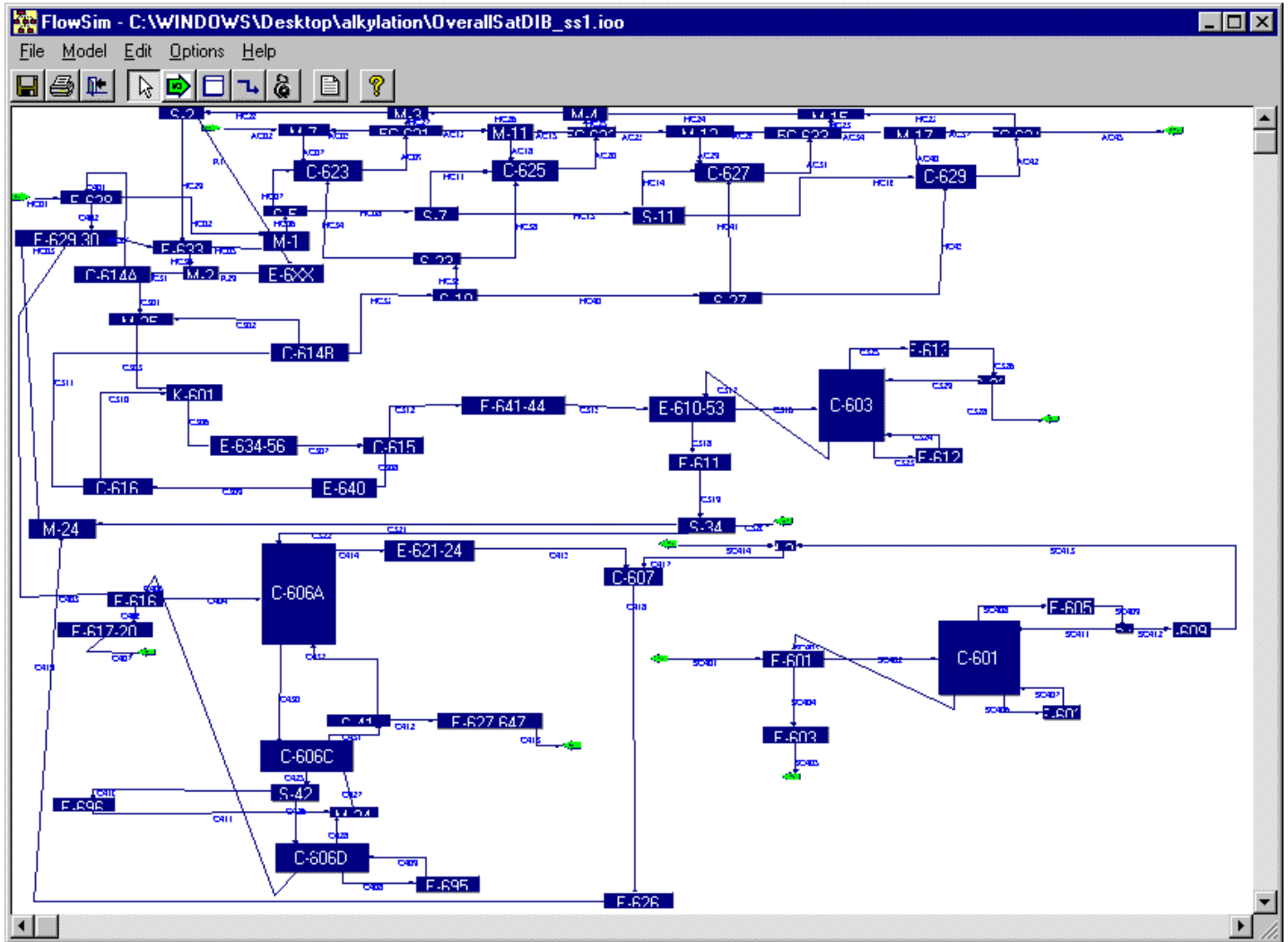


Figure 24. The Flowsim Screen with the Complete Process Diagram for Sulfuric Acid Process Model



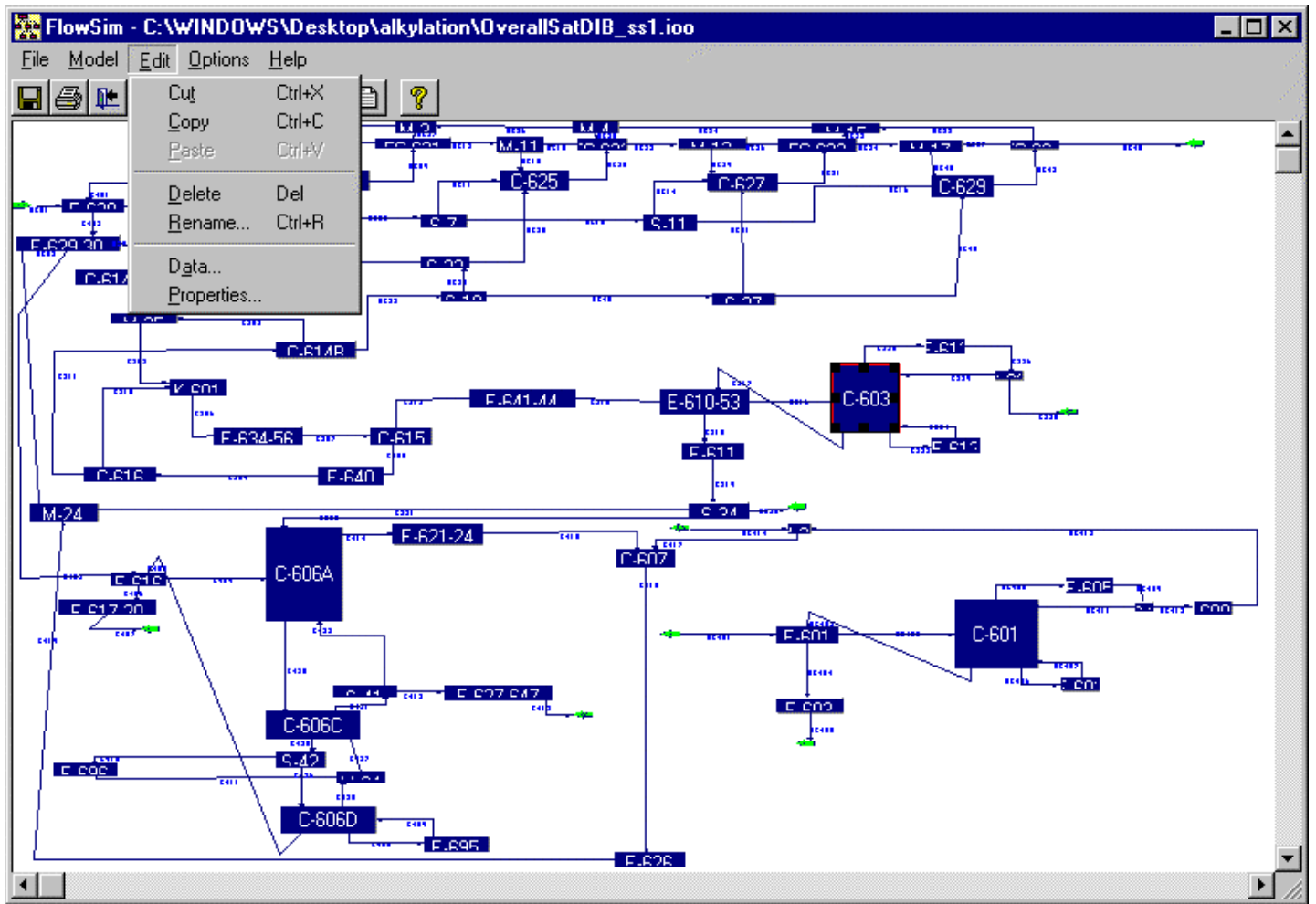


Figure 25. The Edit Menu

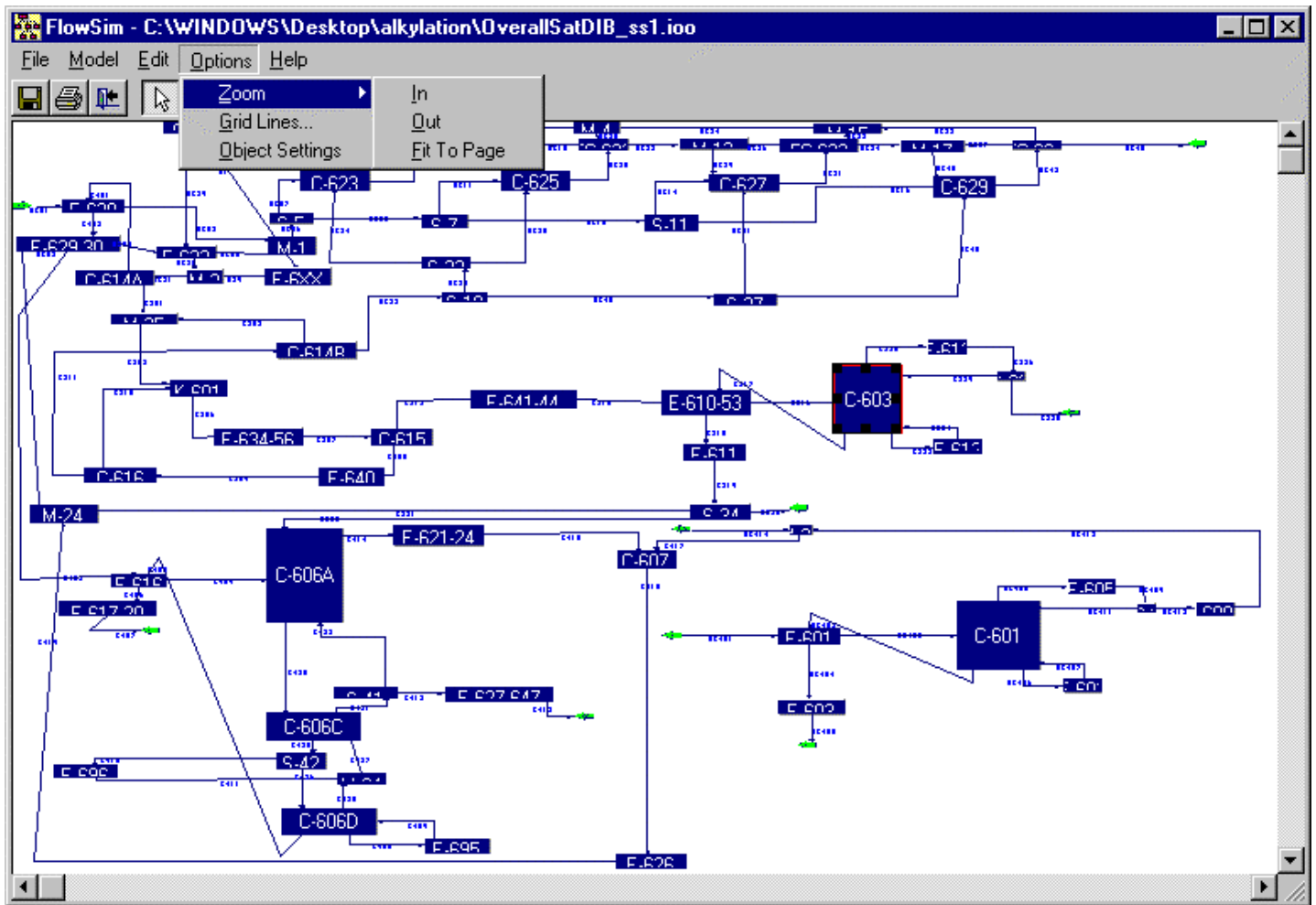


Figure 26. The Options Menu

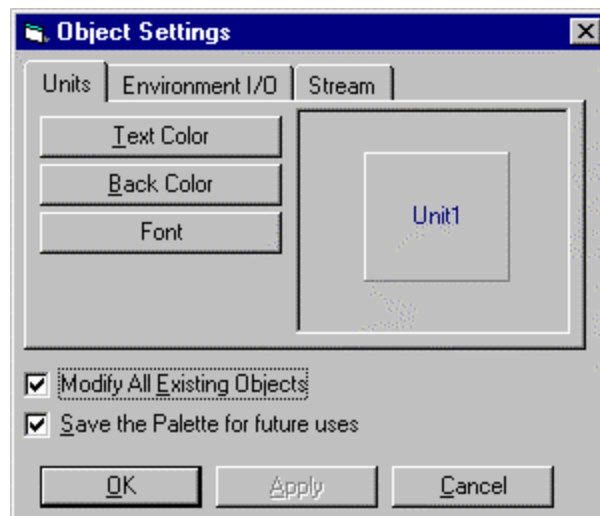


Figure 27. Object Settings Window

The 'Options' menu in the Flowsim screen is shown in Figure 26. The zoom option can be used to change the magnification by zooming in and out. The 'zoom to fit' option will automatically select the appropriate magnification so that the diagram occupies the entire screen. 'Grid Lines' command can be used to display grid lines on the FlowSim screen and to change the spacing between the grid lines. The 'Object settings' command is useful to change the appearance of all the units and streams in the FlowSim screen. The object settings window is shown in Figure 27. To change settings for all the streams, click on the streams tab. To change settings for all the environment I/O units, click on the 'Environment I/O' tab. If you want the changes to remain effective even after you close the application, you must select 'Save the palette for future uses' box.

Once you have drawn a stream, the data associated with the stream can be entered by clicking on the data option in the edit menu or by double clicking on the stream. Let us enter the data associated with the stream HC32. When you double click on this stream, a data form is opened. This is shown in Figure 28.

To enter the measured variables associated with the stream, the 'add' button should be clicked. When the 'add' button is clicked, the caption of the Refresh button changes to 'Cancel'. Then the information about the variable such as the name of the variable, the plant data, the standard deviation of the plant data should be entered. The description, initial point, scaling factor, lower and upper bounds and the unit of the variable are optional.

The changes can be recorded to the model by clicking on the 'Update' button or can be cancelled by clicking on the 'Cancel' button. When the update button is clicked, the caption of the cancel button reverts back to 'Refresh'. The Stream Data Window with the information appears as shown in Figure 28. In this way, all the other measured variables associated with the stream 'HC32' can be entered.

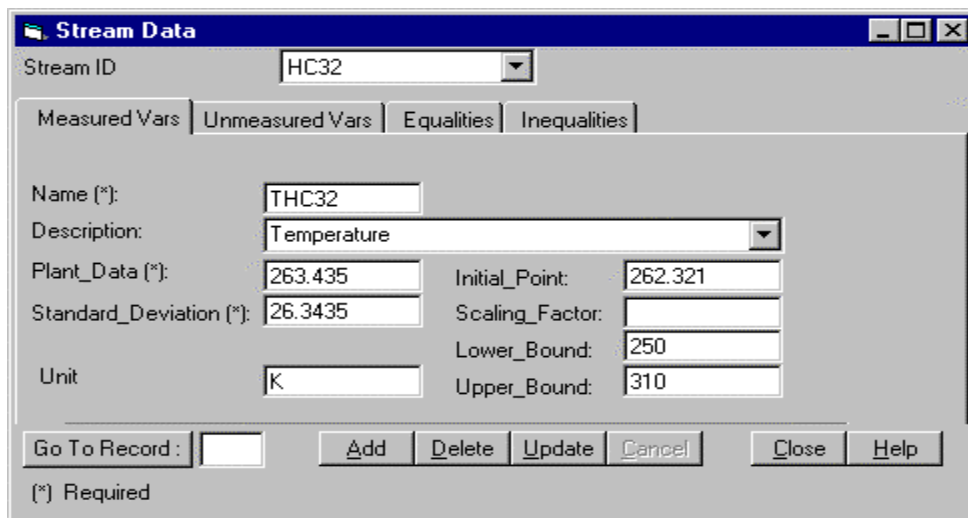


Figure 28. Stream Data Window

The screenshot shows a software window titled "Stream Data" with a blue header bar. Below the header, there is a dropdown menu for "Stream ID" set to "HC32". Below that are four tabs: "Measured Vars", "Unmeasured Vars" (which is selected and has a dotted border), "Equalities", and "Inequalities". The main area contains several input fields: "Name (\*)" with the value "PHC32", "Description:" with a dropdown menu showing "Pressure", "Unit:" with a dropdown menu showing "kPa", "Initial\_Point:" with the value "102.472", "Scaling\_Factor:" (empty), "Lower\_Bound:" with the value "101", and "Upper\_Bound:" with the value "200". At the bottom, there is a "Go To Record:" field (empty) followed by buttons for "Add", "Delete", "Update", "Cancel", "Close", and "Help". A note "(\*) Required" is at the very bottom.

Figure 29 .Unmeasured Variables Tab in the Stream Data Window

To enter the unmeasured variables associated with the stream, click on the ‘Unmeasured Vars’ tab. As explained above for the measured variables, click on the add button in the stream data window. Enter the name, initial point of the unmeasured variable. The bounds, scaling factor, description and unit of the variable are optional. The Stream Data window with the unmeasured variable data is shown in Figure 29.

To move to a particular variable, enter the record number in the box adjacent to ‘Go to Record’ button. Then press ‘enter’ or click on the ‘Go to Record’ button to move to that variable. To delete a variable, first move to that variable and then click ‘Delete’. To return to the main screen, click on the ‘close’ button.

To enter the data associated with a unit, double click on the unit. When you double click on the unit, a data form similar to the one shown in Figure 28 is opened. The measured variables, unmeasured variables are entered in the same way as for the streams.

Let us proceed to enter the equality constraints for the unit S-2. Click on the Equalities tab in the Unit Data window to enter the equality constraints.

Let us enter the overall material balance equation for the S-2. This equation is given in Appendix A. Click on the add button on the Unit Data window. Enter the equation in the box provided and click ‘Update’. Note the use of ‘=e=’ in place of ‘=’ as required by the GAMS programming language. The screen now looks as shown in Figure 30a.

Let us enter another material balance equation for S-2. This equation is also given in Appendix A. The Equality constraints tab in the Unit Data window for S-2 with this equation is shown in Figure 30.b.

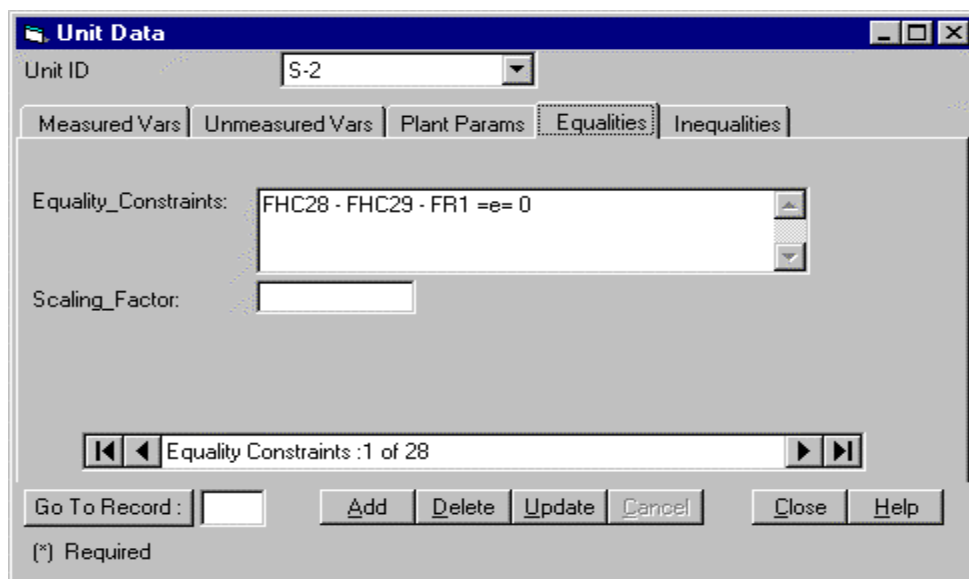


Figure 30.a. Equality Constraints Tab in the Unit Data Window

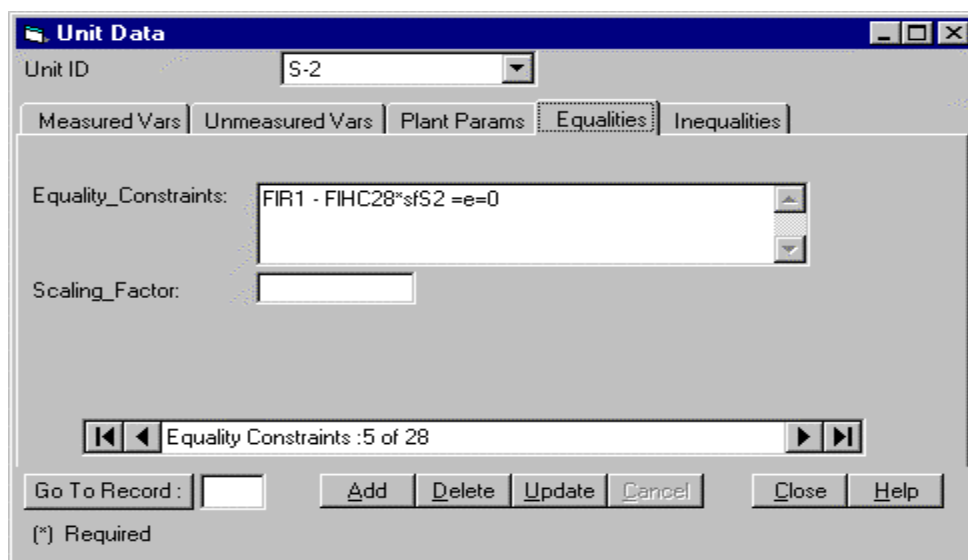


Figure 30.b. Equality Constraints Tab in the Unit Data Window

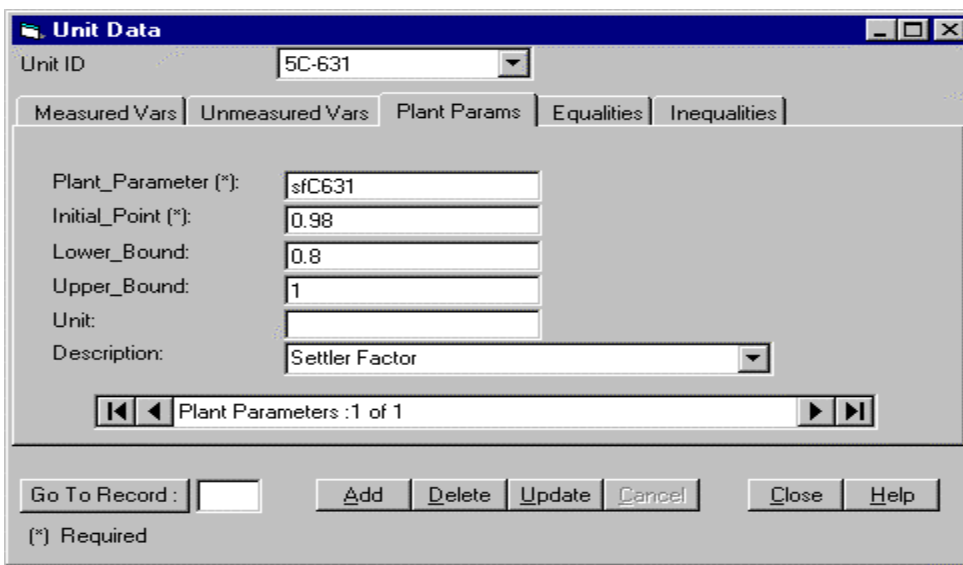


Figure 31. Plant Parameters tab in the Unit Data window

Unit Data window has an extra tab for entering the parameters in the model, which are associated with that particular unit. Let us enter the parameter for the 5C-631 unit. Double click on the unit to open the Unit Data window. In the Unit Data window, click on the ‘Plant Params’ tab. Click on the ‘Add’ button. The parameter name and the initial point are required. Enter ‘sfC631’ as the parameter name. This is the settler factor for Settler I (5C-631). The bounds, description and the unit of the parameter are optional. The Unit Data window with the parameter information is shown in Figure 31.

### A. Global Data

If there are variables, parameters and equations that do not belong to either a unit or a stream, then they can be entered in the Global Data window. This includes the economic model and the equations to evaluate emissions and energy use. To enter this global data, double click on the background of the flowsheet diagram or click on the ‘Global Data’ option in the Model menu.

The Global Data window in Figure 32.a shows an equation that calculates the cost for the Alkylation process when the process is optimized. Other equality constraints can be added in this window in a similar way. For the Alkylation process, let us enter another equation that defines the profit function for the whole process. Click on the ‘add’ button and enter the equation as shown in Figure 32.b. The variable ‘Profit’ will be used later to specify the objective function for economic optimization. As seen in Figure 32.b, the profit function is equal to the ‘Earnings’ less the ‘Cost’ and the ‘Utilities’. This profit function can be entered in the ‘Economic Eqn’ section of the Global Data window.

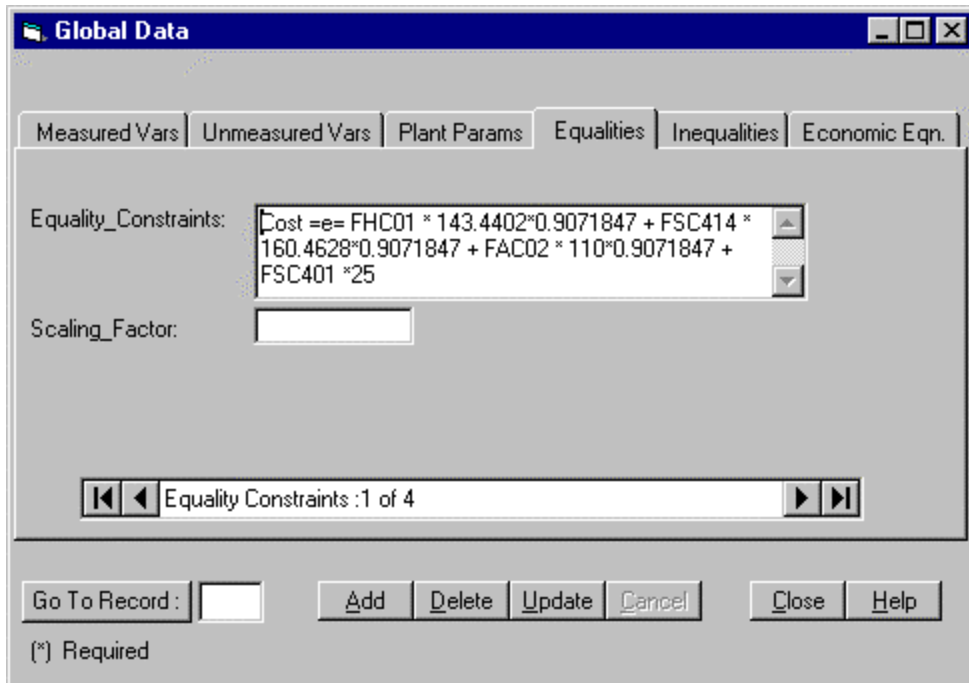


Figure 32.a Equalities Tab in the Global Data Window

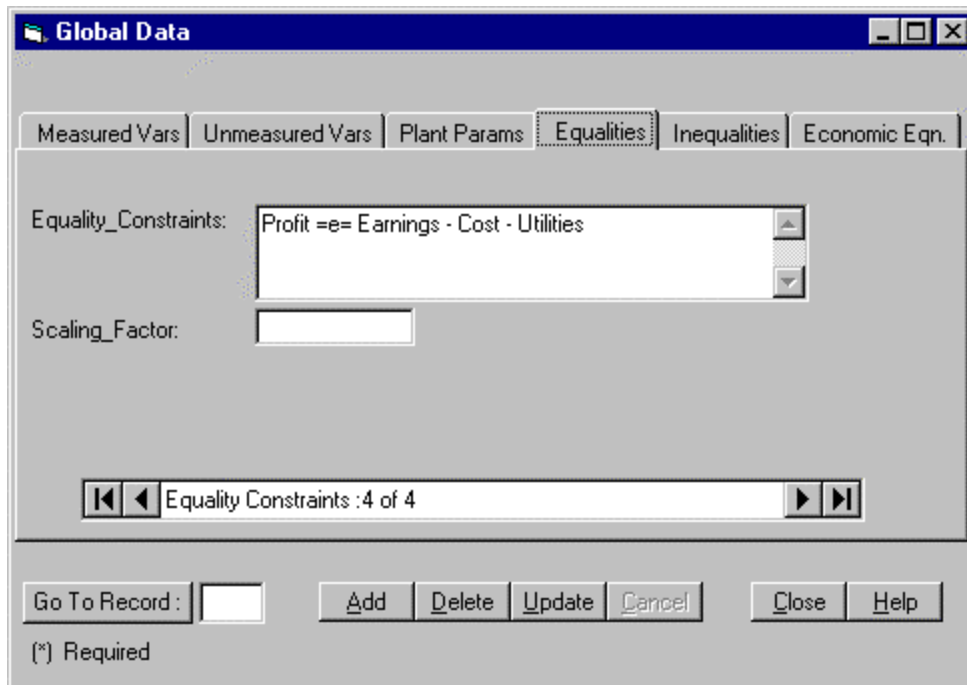


Figure 32.b. The Economic Equations Tab of Global Data

## B. Tables

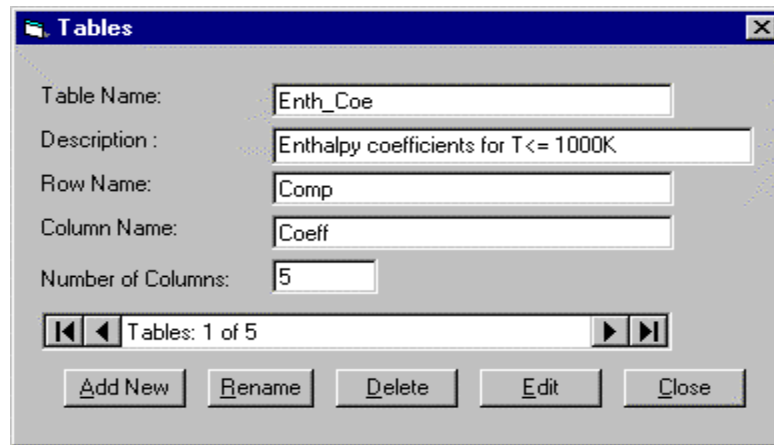


Figure 33. Tables Window

If there are constant coefficients used in the constraints equations, they can be defined as a table. These constant coefficients are grouped in sets, and they can be defined using concise names to refer their values in the equations before an equation definition. Along with constant coefficients enthalpy coefficients for streams can also be entered in this section.

The enthalpy of a stream usually is expressed as a polynomial function of temperature. This function appears repeatedly in the plant model with the same coefficients, which have different numerical values for each chemical component. An example is:

$$h_i = a_{0i} + a_{1i}T + a_{2i} T^2 + a_{3i} T^3 + a_{4i} T^4 + a_{5i} T^5$$

where there are six coefficients,  $a_{0i}$  to  $a_{5i}$ , for component  $i$ .

Let us create a new table for the Alkylation model. Click on the 'Tables' option in the model menu to open the Tables window, which is shown in Figure 33. Then click on the 'Add New' button in the tables window to activate the window. As soon as 'Add New' button is clicked, the caption of the 'Add New' button changes to 'Save' and that of 'Delete' changes to 'Cancel'. Then the general information of a table: the name of the table, rows and columns as well as the number of columns, must be entered from in the window. The name of the table stands for the name of the coefficient group. The names of rows and columns are the set names of the sub-components. After entering the table information, the 'Save' button should be clicked to save the changes.

To enter data in a table, click on the 'Edit' button. The Edit Table window is opened names and numerical values of constant coefficients. The edit table window for the table 'Enth\_Coe' is shown in Figure 34. Clicking the 'Close' button will update the table and close the 'Edit table' window. An existing table can be edited or deleted by selecting the table and then clicking 'Edit' or 'Delete'.



Column0	Column1	Column2	Column3	Column4	Column5
	a1	a2	a3	a4	a5
1	4.211	1.716e-03	7.062e-05	-9.196e-08	3.644e-11
2	4.4267	6.6394e-03	6.8065e-05	-9.2875e-08	3.7347e-11
3	4.455	8.261e-03	8.299e-05	-1.146e-07	4.646e-11
4	6.147	1.559e-04	9.679e-05	-1.255e-07	4.978e-11
5	1.083	4.457e-02	8.239e-06	-3.526e-08	1.579e-11
6	1.898	4.12e-02	1.231e-05	-3.659e-08	1.504e-11
7	8.763	2.162e-03	1.317e-04	-1.738e-07	6.925e-11
8	1.115e01	-9.494e-03	1.956e-04	-2.498e-07	9.489e-11
9	8.157e-01	7.326e-02	1.783e-05	-6.936e-08	3.216e-11
10	2.876	7.579e-02	1.346e-05	-6.409e-08	2.869e-11
*					

Figure 34. Edit Table Window

### C. Constant Properties

The Constant Property window is where a list of constants is stored. Clicking on the ‘Constants’ option in the model menu opens the Constant Property window as shown in Figure 35. To create a set of constant properties, click on the ‘Add New’ button in Constant Property window to activate the window. As soon as ‘Add New’ button is clicked, the caption of the ‘Add New’ button changes to ‘Save’ and that of ‘Delete’ changes to ‘Cancel’. Then the general information of a constant property: the name and an optional description must be entered in the Constant Property window.

After entering the constant property information, the ‘Save’ button should be clicked to save the changes.

The screenshot shows a window titled "Constant Properties" with a close button in the top right corner. Inside the window, there are two text input fields: "Constant Properties:" containing "Scalar\_ExchArea" and "Description:" containing "Heat transfer areas". Below these fields is a list box showing "Constant Properties: 2 of 9" with navigation arrows. At the bottom of the window are five buttons: "Add New", "Delete", "Edit", "Rename", and "Close".

Figure 35. Constant Properties Window

Name	Value	Description
E01A	0.0872	*10000 square feet
E02A	0.393	"
E03A	0.1052	"
E05A	0.461	"
E09A	0.0354	"
AE610	150.5	m2
AE611	110.55	m2
AE612	263.84	m2
AE613	431.07	m2
AE616	106	m2
AE617	106	m2
AE621A	346	m2
AE626	308	m2
AE627A	42	m2
AE628	88.7	m2
AE629	743	m2
AE633	284	m2
AE634	3820	m2

Figure 36. Edit Constant Property Window

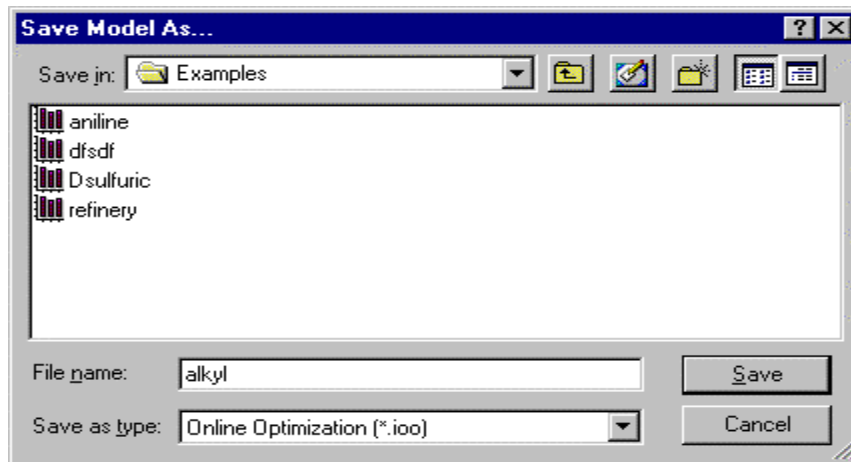


Figure 37. Save Model As Dialog Box

To enter the data in the constant property window, click on the 'Edit' button. The Edit Constant Property window is opened for entering the numerical values of the constants. The name of the constant, the corresponding numerical value and an optional description. The Edit Constant Property window is shown in Figure 36.

After entering all of the above information, the model is complete. Save the changes by clicking on the 'Save' option in the File menu. If you click 'Exit' without saving the model, a message is displayed asking whether you want to save the changes or not. The 'Print' option in the File menu when clicked, prints the flowsheet diagram. When 'Exit' button is clicked, Flowsim window is closed and the user is taken back to the Advanced Process Analysis Desk.

The development of the process model using Flowsim has been completed. The equations, parameters and constants have been stored in the database as shown in Figure 1. Save the model using the 'Save As' option in the File menu shown in Figure 19. A 'Save Model As' dialog box shown in Figure 37 is opened. Save the model as 'Alkyl.ioo' in the 'Examples' subdirectory of the program folder.

The process model developed above needs to be validated to make sure that it is representing the actual process accurately and it does not have any mistakes. This can be done by using the model to carry out a simulation and then comparing the results with the design data for the process. If the design data is not available, an alternative solution is to use the combined gross error detection and data reconciliation step of on-line optimization to check the model validity. The plant operating data obtained from the distributed control system can be used for this purpose. The reconciled data obtained is compared with the plant data and if the values agree within the accuracy of the data, the model is an accurate description of the actual process. For the Alkylation process, this strategy is used to validate the model. The combined gross error detection and data reconciliation is the first step of on-line optimization and will be explained in the next section.

The next step of the Advanced Process Analysis System is on-line optimization. The 'On-line Optimization' button in Figure 15 should be now clicked to open the On-line Optimization program.

## **VI. USING ONLINE OPTIMIZATION PROGRAM**

Upon clicking the 'On-line Optimization' button, On-line Optimization main window is displayed with the Model Description window as shown in Figure 38.

The model name and the description were entered in the Flowsim program. This Model Description window also includes the Optimization Objective and Model Type. The optimization objective can be selected from the drop-down list of 'Optimization Objective'. The five selections are: 'On-line Optimization (All)', 'Data Validation', 'Parameter Estimation', 'Economic Optimization' and 'Parameter Estimation and Economic Optimization'. Let us choose the 'Online Optimization (All)' option for the optimization objective. The model type of the plant model must be specified as either 'Linear' or 'Nonlinear' from the drop-down list. Let us choose 'Nonlinear' as the model type for the Alkylation model.

When you click on the View menu in the Model Description window, a pull down menu is displayed as shown in Figure 39. The View menu includes commands for the All Information mode, The

Online Optimization Algorithms and Flow sheet diagram. The ‘All Information’ mode is used to switch between windows. The ‘All Information’ mode displays the different windows combined together into one switchable window. The Flowsheet diagram option is used to view the flowsheet diagram, which is drawn using the flowsheet simulation program.

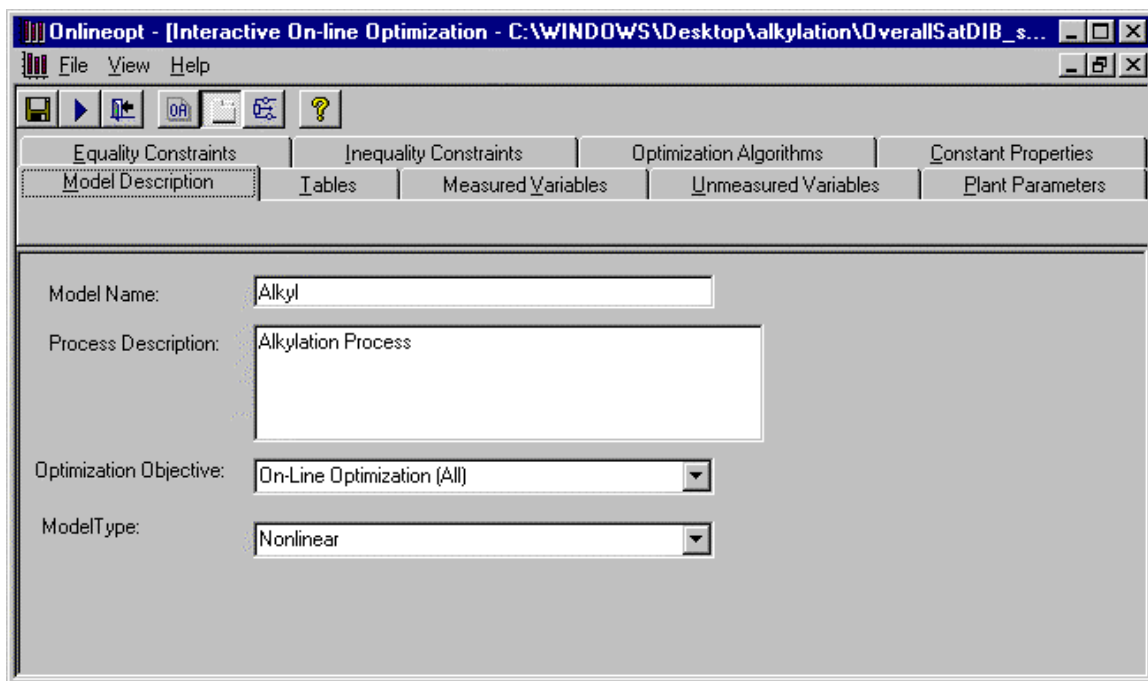


Figure 38. Model Description Window

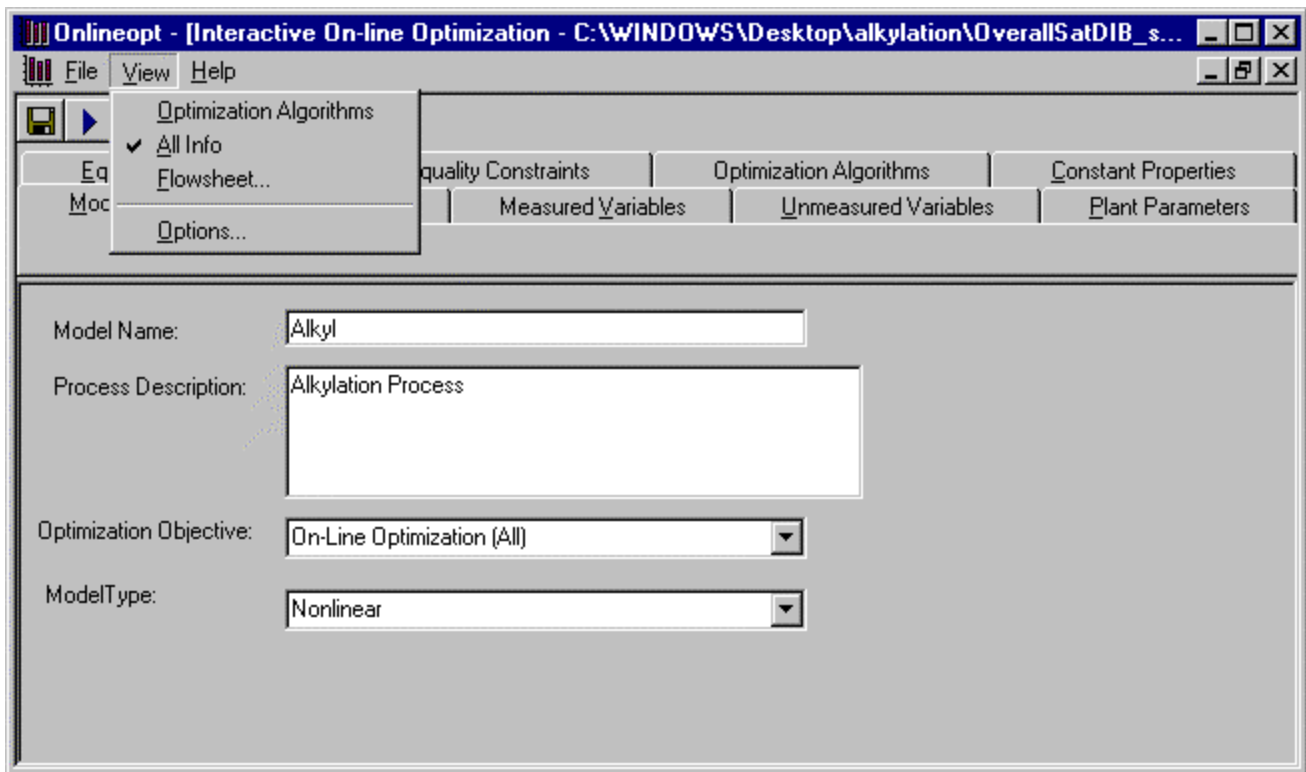


Figure 39. View Menu

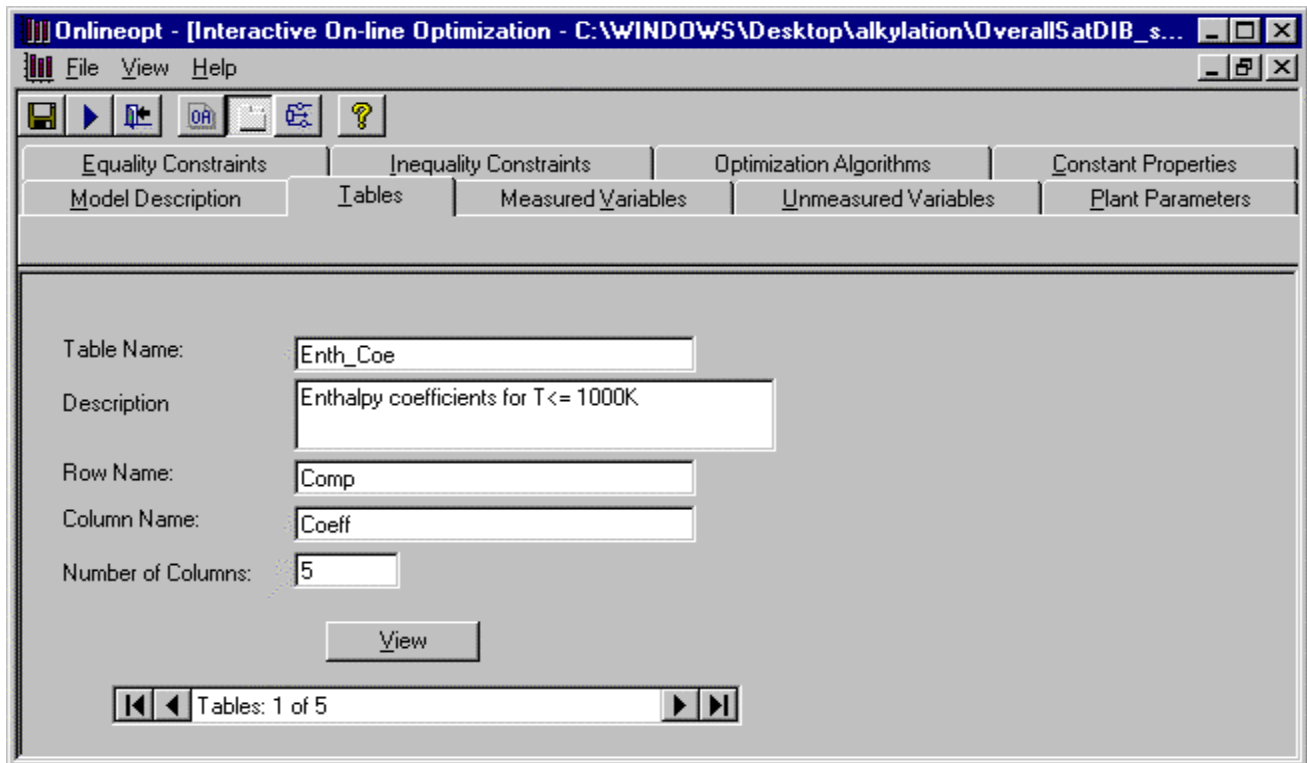


Figure 40. Tables Window

When the information for the Model Description window is completed, you can proceed to the Tables window by clicking on the Tables tab in the All-Information mode. The tables window is shown in Figure 40, which contains information about the tables which were entered in Flowsim program.

Let us proceed to the Measured Variables window by clicking the Measured Variables tab. The Measured Variables window has a table with twelve columns which display the name, plant data, standard deviation, initial point, scaling factor, lower and upper bounds, stream number, process unit ID, the unit and a short description of the measured variables. The Measured Variables window lists all the measured variables that are associated with all the units and streams in the process model and the global measured variables that were entered in the Flowsim program. The column 'Process Unit ID' has the name of the process unit and the column 'Stream Number' has the name of the stream with which the variable is associated. The Measured Variables window is shown in Figure 41. In this window, information can only be viewed. All of the data entered in Flowsim can only be viewed using the screens of on-line optimization. To change the data, the user has to go back to Flowsim program.

Then proceed to the Unmeasured variables window by clicking on the Unmeasured Variables tab. The Unmeasured variables window has nine columns for displaying the name, initial point, scaling factor, lower and upper bounds, stream number, process unitID, unit and description of the unmeasured variables. The Unmeasured Variables window lists all the unmeasured variables, which were entered in the Flowsim program. The Unmeasured Variables window is shown in Figure 42.

Name	Plant Data	Standard Deviation Plant Data	Initial Point	Scaling Factor
FAC02	0.11249	0.011249	0.139	
FAC12	0.1259	0.01259	0.139	
FAC23	0.12534	0.012534	0.139	
FAC34	0.13892	0.013892	0.139	
FAC45	0.104	0.0104	0.139	
FC308	2.199	0.2199	2.45	
FC320	0.1468	0.01468	0.148	
FC322	0.4427	0.04427	2.416	
FC403	3.8766	0.38766	2.088	
FC407	1.107	0.1107	1.029	
FC412	0.03238	0.003238	0.06	0.01
FC417	0.2799	0.02799	0.276	
FHC01	1.01547	0.101547	0.795	
FHC32	1.8596	0.18596	1.814	

Include SCALING OPTION for variables

Figure 41. Measured Variables Window

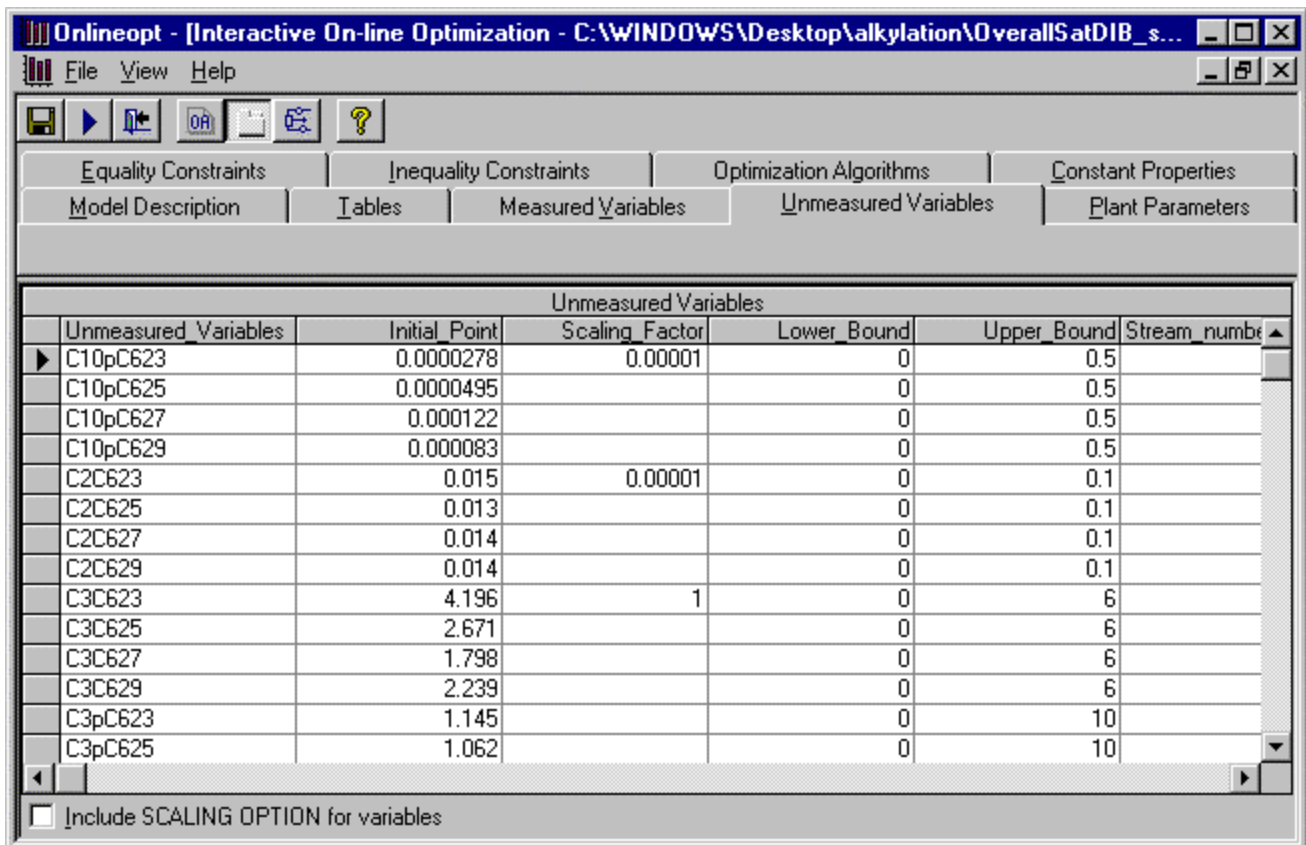


Figure 42. Unmeasured Variables Window

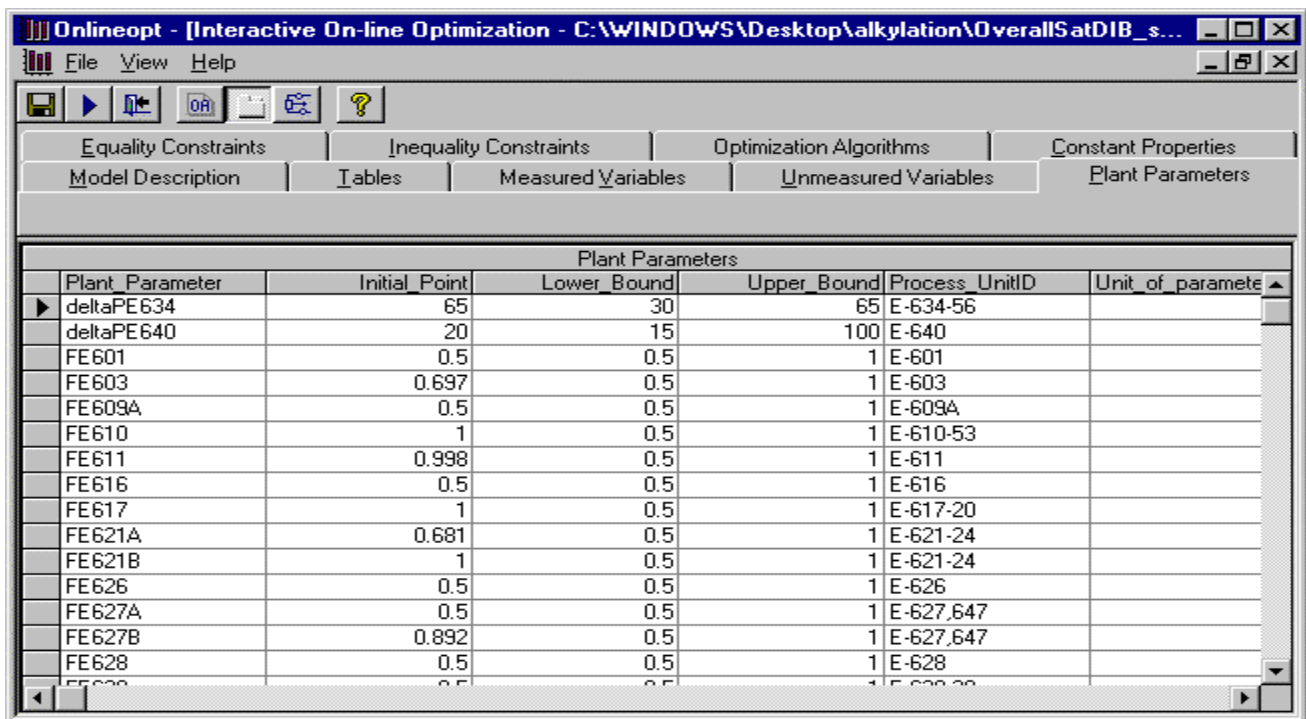


Figure 43. Plant Parameters Window

Optimization programs need to have all the variables in the same numerical range, and it may be necessary to scale the variables by adjusting the scaling factors. For the Alkylation model, the unmeasured variables should be scaled. To scale variables using Scaling Option provided by the system, the scale factors must be entered in the Flowsim program and the icon 'Include Scaling Option for variables' at the bottom of Figure 42 should be checked. A description of scaling factors and their use is given in Section X.

Let us proceed to the Plant Parameters window by clicking on Plant Parameters tab. The Plant Parameters window lists all the parameters entered in the Unit and the Global Data window of the Flowsim program. The Plant Parameters window is shown in Figure 43.

Then proceed to the Equality Constraints window. This window has four columns for displaying the constraints, scaling factor, process unitID and stream number. All the equality constraints entered in the Flowsim program are listed in this window. The equality constraints window is shown in Figure 44. The next step is the Inequality Constraints window, which is similar to the Equality Constraints window. The Inequality Constraints window has three columns for displaying the constraints, process unitID and stream number. Scaling factors are not available for inequality constraints.

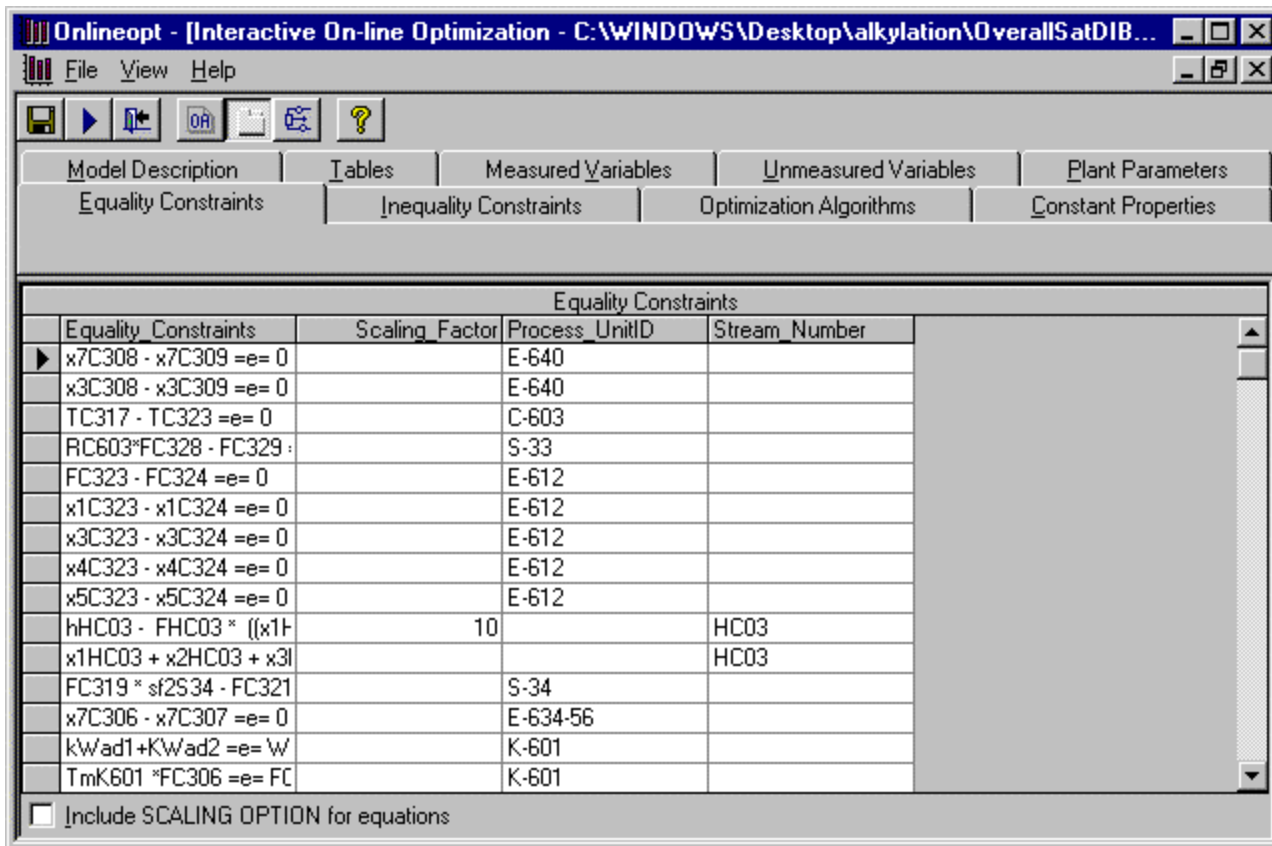


Figure 44. Equality Constraints Window



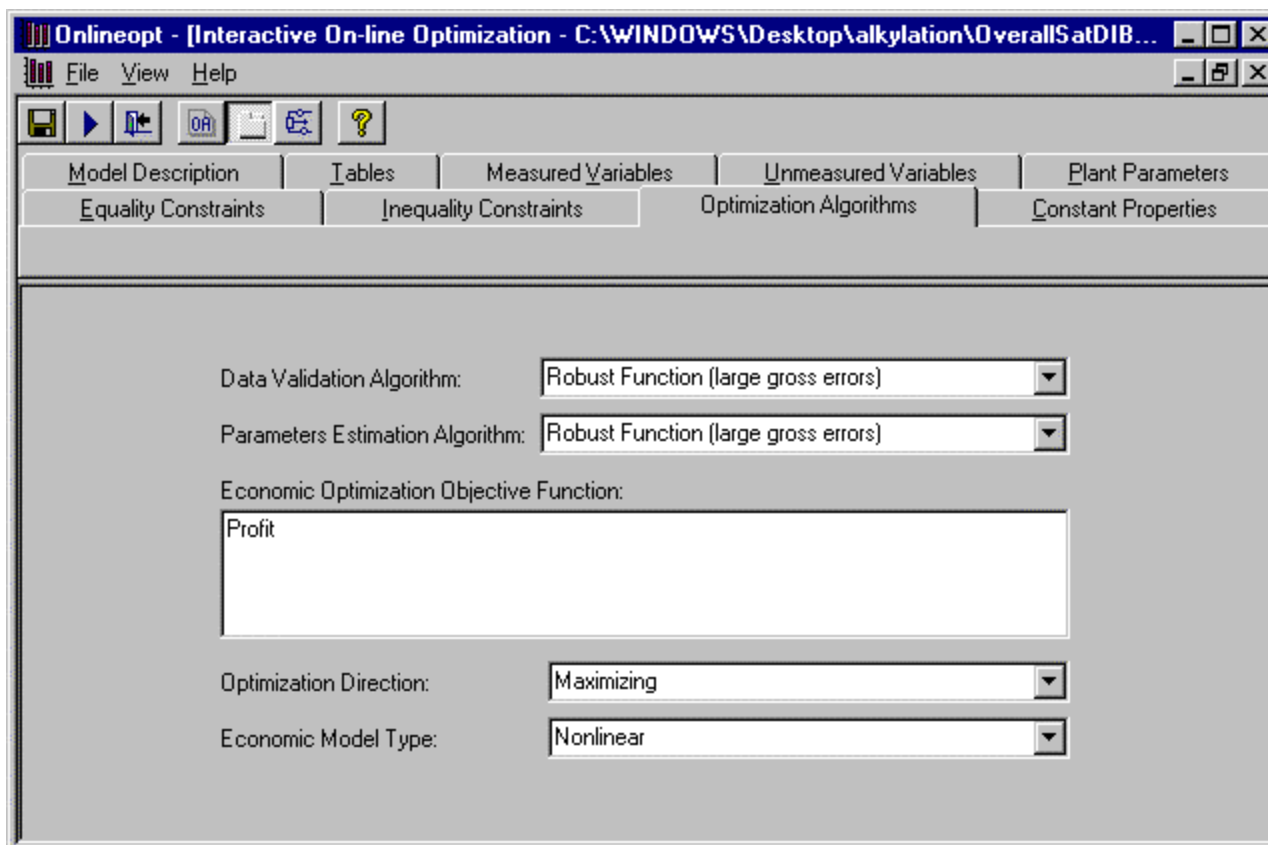


Figure 45. Optimization Algorithms Window

Let us proceed to the Optimization Algorithm window shown in Figure 45. This window includes the algorithms for Data Validation and Parameter Estimation, the Objective function for Economic Optimization, the Optimization direction and the Economic Model type. The options for Alkylation model are ‘Robust Function (large gross errors)’ for data validation and ‘Robust Function (large gross errors)’ for Parameter Estimation. In the Economic Optimization for the Alkylation process, the objective function is ‘profit’ defined in Section V in a global equality constraints(Figure 31.b). Let us choose the optimization direction to be ‘Maximizing’ and the Economic Model type to be ‘NonLinear’.

The next step is the Constant Properties window. The constant properties window is shown in Figure 46-A.

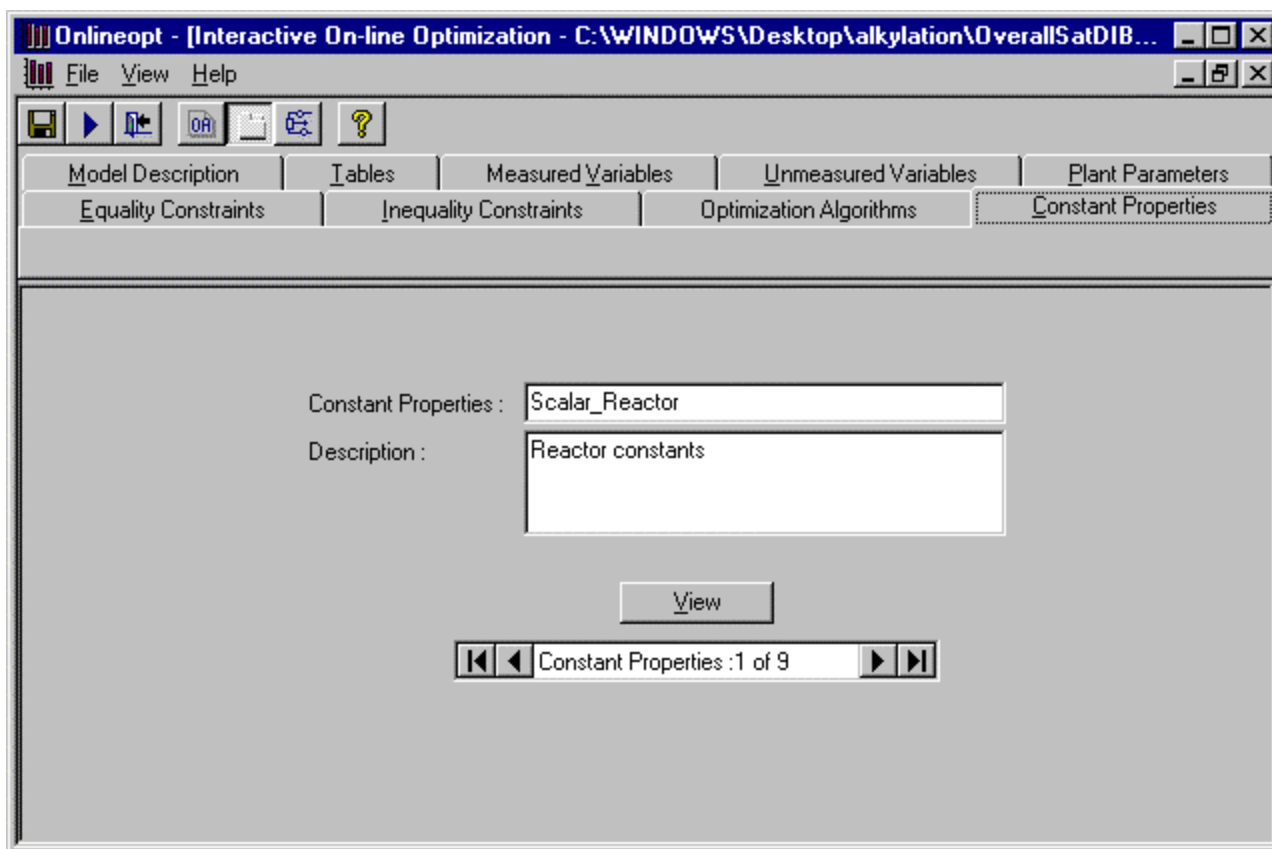


Figure 46-A. Constant Properties Window

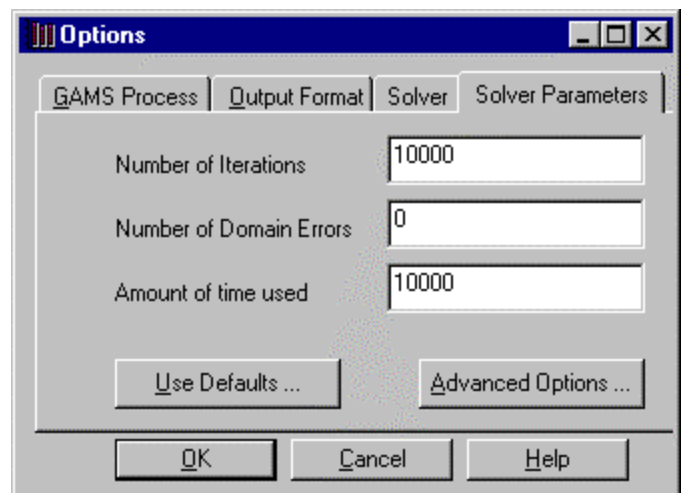
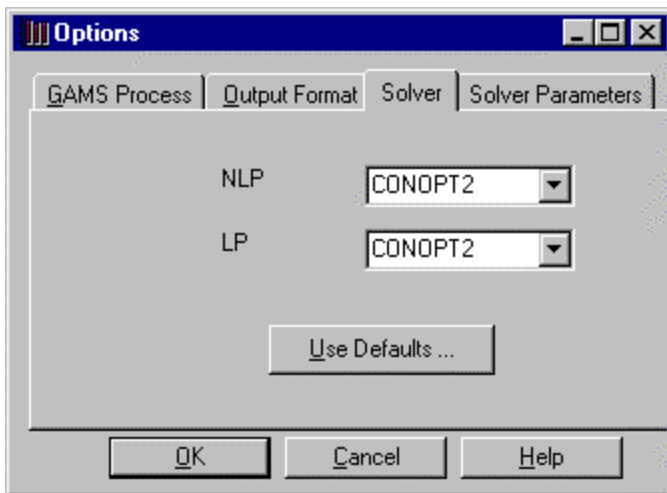
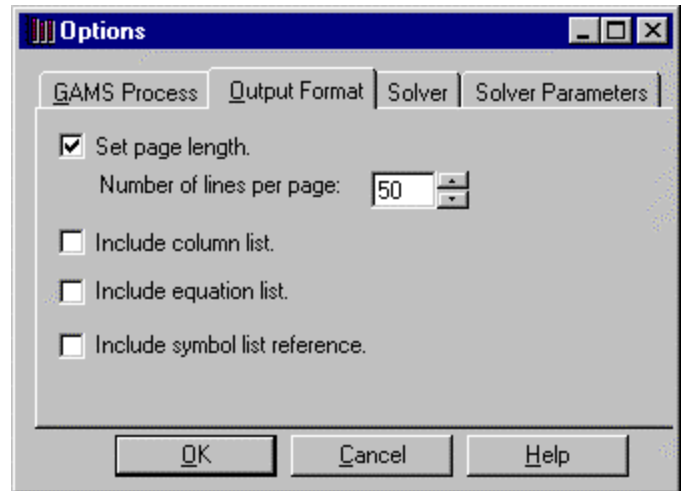
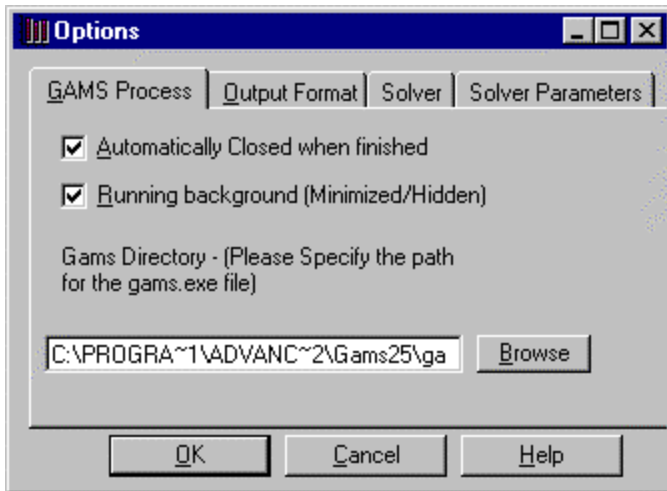


Figure 46-B. Options

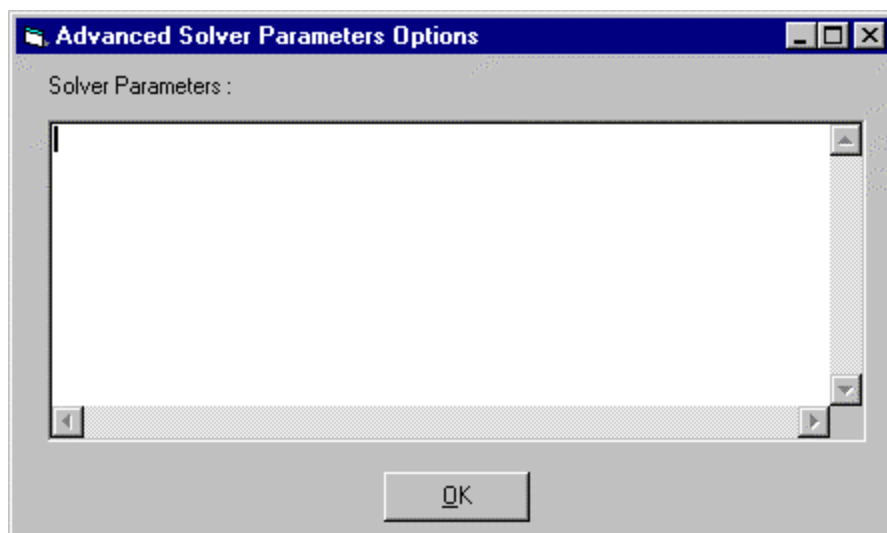


Figure 46-C. Advanced Parameters Options Window

Clicking on the 'Options' item in 'View' menu, opens the Options window as shown in Figure 46-B. General GAMS Process options are set in the 'GAMS Process' tab as shown in the first window of Figure 46-B. The format for the GAMS output can be specified in the 'Output Format' tab as shown in second window of Figure 46-B. LP and NLP values for the Solver can be set in the 'Solver' tab as shown in the third window of Figure 46-B. The default values are CONOPT for both LP and NLP. These default values can be restored by clicking on the 'Use Defaults...' button. The LP and NLP values for Alkyltion process are CONOPT2 and CONOPT2. Solver Parameters like Number of Iterations, Number of Domain Errors and Amount of Time Used can be specified in the 'Solver Parameters' tab as shown in the fourth window of Figure 46-B. The recommended values for Solver Parameters of the Alkyltion process are Number of iterations 5000, Domain Errors 0, and Amount of time used 5000 sec. The default values can be restored by clicking on the 'Use Defaults...' button. Other advanced options can be set by clicking on the 'Advanced Options' button, which brings up the window shown in Figure 46-C. For the alkyltion process advanced options are specified by providing CONOPT2.OPT file and adding the following line in gamsprm95.txt " OPTFILE =1".

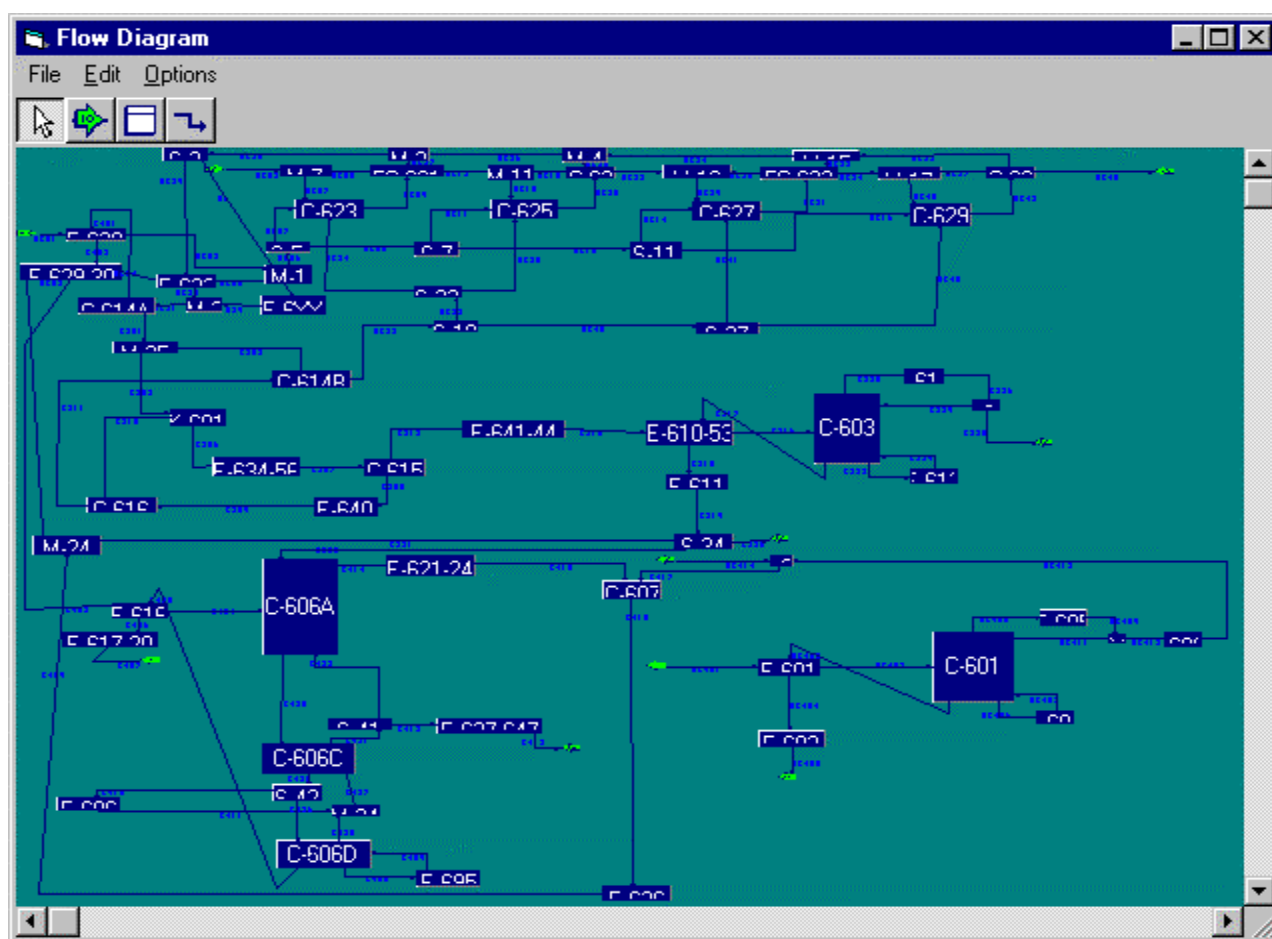


Figure 47. Flowsheet Diagram Window

The flowsheet diagram can be viewed by clicking on the 'FlowSheet Diagram' option in the view menu as shown in Figure 39. The flowsheet cannot be edited in the On-line Optimization program. The flowsheet diagram is shown in Figure 47. Double clicking on a unit opens a data form, which displays all the measured variables, unmeasured variables and plant parameters that are associated with that unit. Similarly double clicking on a stream opens a data form, which displays the measured and unmeasured variables, associated with the stream. The global data can be viewed by double clicking on the background of the flowsheet.

After entering the required information, let us proceed to execute the model. To execute the model, click on the 'Execute' option in the File menu or click on the 'Execute' button in the toolbar. Once the 'Execute' option is clicked the Model Summary and Execute window as shown in Figure 48 is opened. This window gives the summary of the contact process.

When the 'Execute' button in the 'Model Execute and Summary' window is clicked, the program first extracts the model information from the database. Based on this information, it generates the GAMS input files and calls the GAMS solver. The progress of GAMS program execution is shown in Figure 49. This window is automatically closed as soon as the execution is over. When the execution of the program is completed, it displays the results of on-line optimization results in the Output window.

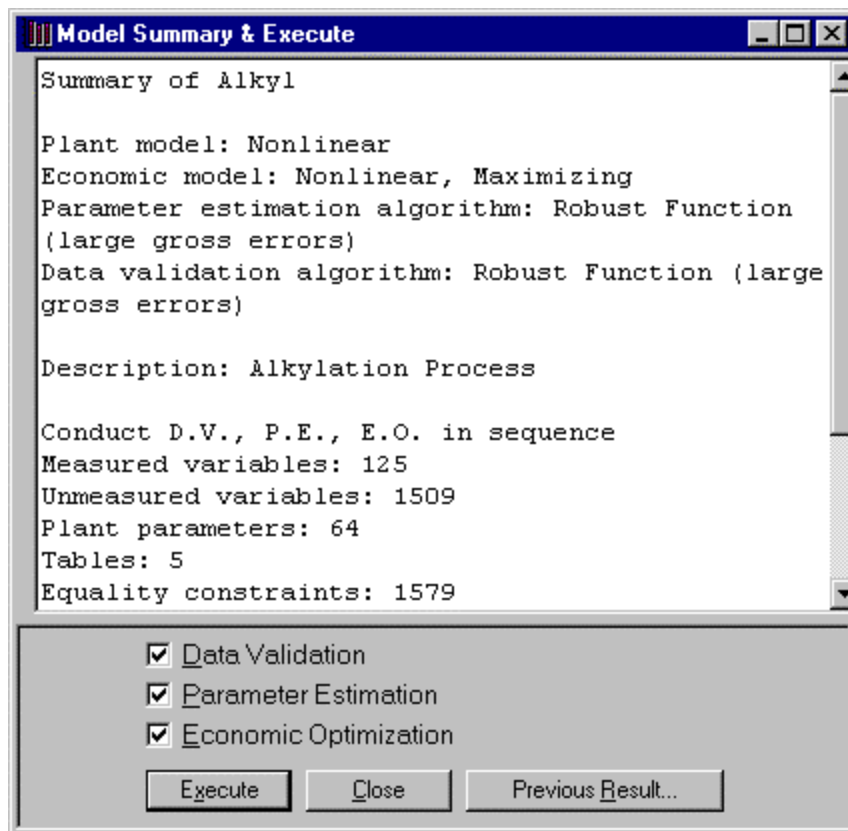


Figure 48. Model Execution and Summary Window

```

GMSCO2NX
Auto
---- DO_DATA(4780) 2 Mb
---- Starting execution
---- DO_DATA(4778) 2 Mb
---- Generating model ALKYL
---- DO_DATA(4779) 3 Mb
---- 1630 rows, 1635 columns, and 6716 non-zeroes.
---- Executing CONOPT2

      C O N O P T   Wintel version 2.070F-003-035
      Copyright (C) ARKI Consulting and Development A/S
                    Bagsvaerdvej 246 A
                    DK-2880 Bagsvaerd, Denmark

Using control program file C:\PROGRAM FILES\GAMSIDE\CONOPT2.OPT

Rtmaxj=1E9;
rtnwmj=1E-9;
*rtredg=1E-9;
*lslack =t;
lsscal= t;
*lstcrs =t;
lfstal =3000;

```

Figure 49. GAMS Program Execution Window

A GAMS licensed software is required to execute this program. This Alkylation plant has 1,579 equality constraints and 50 inequality constraints, and the free or demonstration version is limited to 300 constraint equations. The results for the optimization case are included. And can be seen by clicking on the button “Previous Results” in Figure 48. A licensed version can be obtained from the GAMS Development Corporation([www.gams.com](http://www.gams.com)).

After the three programs have been executed, three detailed GAMS output files will be generated by GAMS for the three optimization problems. These files give detailed solutions of the optimization problems for Data Validation, Parameter Estimation and Economic Optimization. Also, a final report is generated by Interactive On-line Optimization system. In the final report, the estimated values of parameters, the reconciled values of process variables, the optimal set points and profit from Economic Optimization are shown. The Output Window with the Final Report is shown in Figure 50. The View menu in the Output window has three options namely Final Report, Full output and Flowsheet.

The Final Report options has five options namely the Economic Objective, Measured Variables, Unmeasured Variables, Plant Parameters and the Stream number as shown in Figure 51. The Economic Objective value is shown in Figure 50.

When the option ‘Measured Variables’ in the Final Report menu is clicked, the system opens a spreadsheet data form which includes the optimal setpoints from economic optimization, reconciled value from Data Validation, reconciled value from Parameter Estimation and the plant data as shown in Figure 52. Clicking on “Plant parameters” in Final Report menu, the system opens a spreadsheet data form that includes the estimated values of plant parameters as shown in Figure 53.

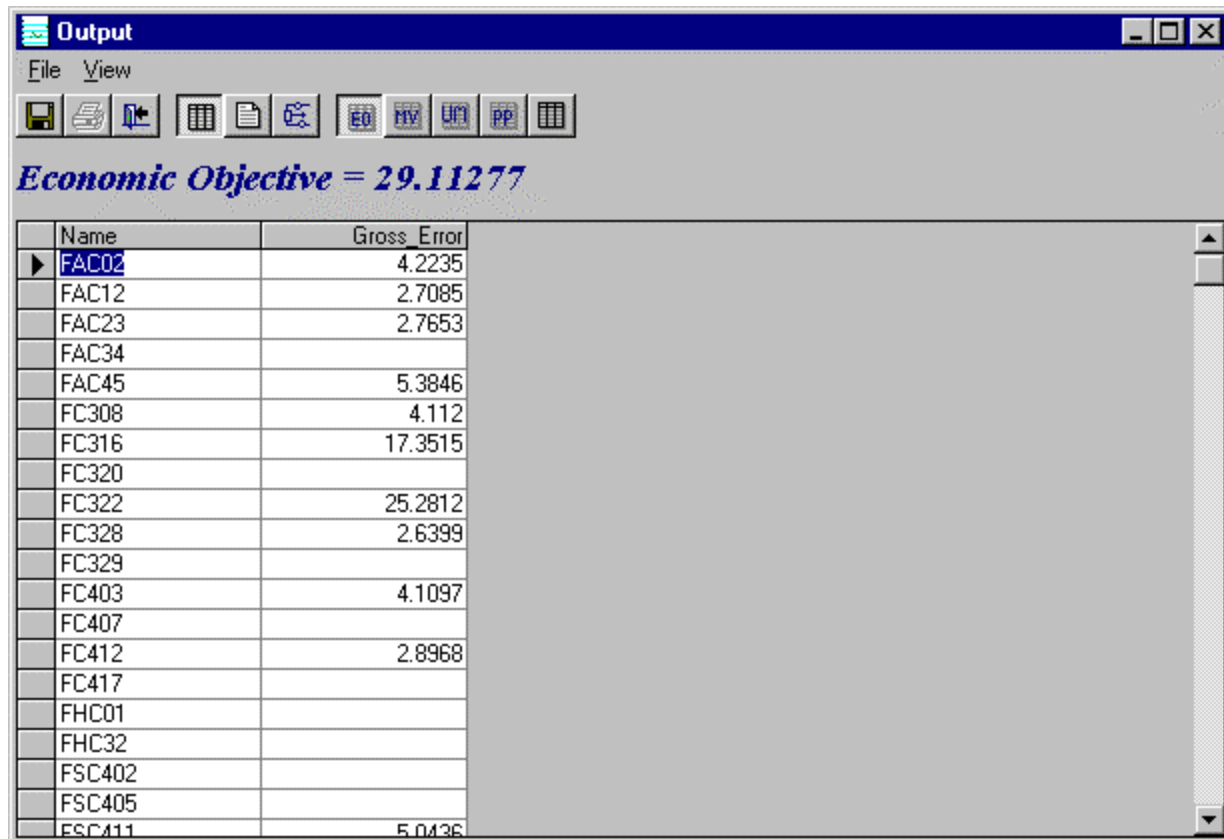


Figure 50. Final Report in the Output Window

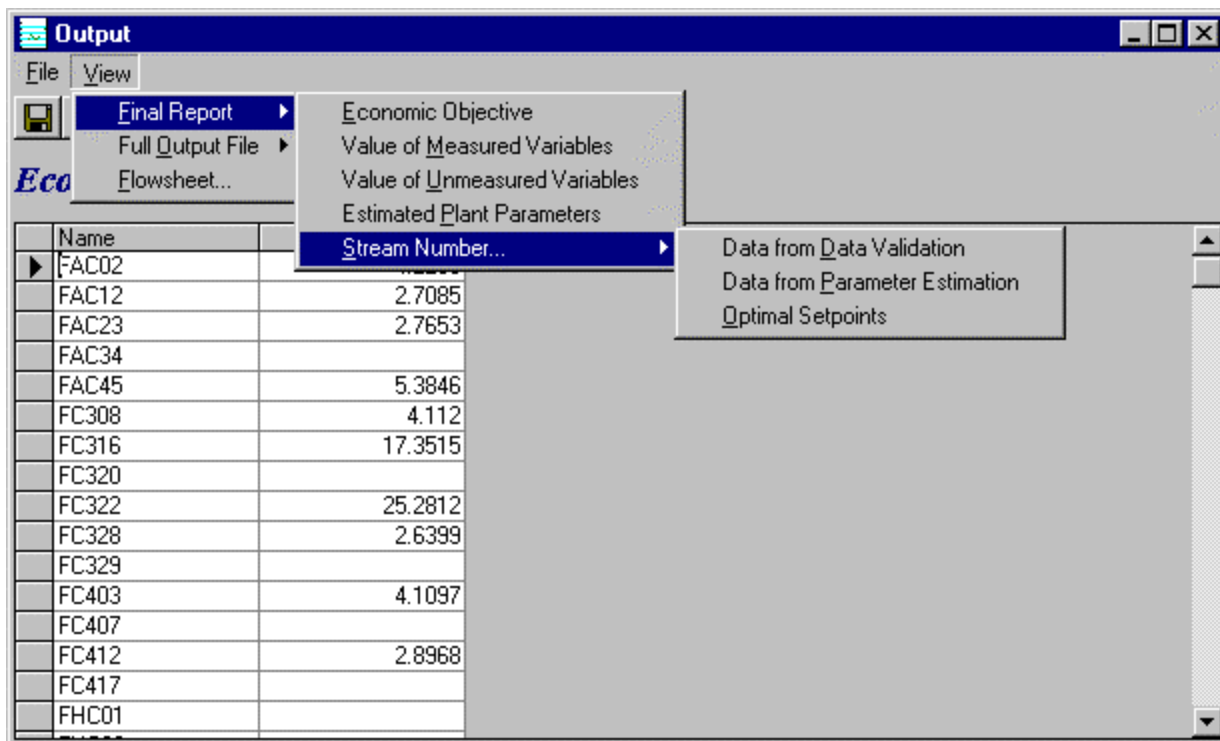


Figure 51. View Menu in the Output Window

5/15/01 4:50:00 PM

Name	Optimal Set Point	Reconciled Data From Parameter Estimation	Reconciled Data From [unclear]
FAC02	0.16	0.16	
FAC12	0.16	0.16	
FAC23	0.16	0.16	
FAC34	0.16	0.16	
FAC45	0.16	0.16	
FC308	3.11969	3.06062	
FC316	1.75181	1.8	
FC320	0.04588	0.14899	
FC322	1.56839	1.56439	
FC328	0.05454	0.05468	
FC329	0.76351	0.7655	
FC403	2.36768	2.32233	
FC407	0.93479	0.92048	
FC412	0.042	0.04205	
FC417	0.14393	0.27541	
FHC01	0.89795	0.85693	
FHC32	1.95688	1.84545	
FHC403	0.45007	0.40155	

Figure 52. Optimal Set points and Reconciled Data in Final Report for Measured Variables

5/15/01 4:50:00 PM

Plant Parameter	Initial Point	Estimated Value	Process UnitID	Unit of Parameter
deltaPE634	70	70	E-634-56	
deltaPE640	20	20	E-640	
FE601	0.5	0.5	E-601	
FE603	1	1	E-603	
FE609A	0.5	0.5	E-609A	
FE610	1	0.93398	E-610-53	
FE611	0.5	0.52182	E-611	
FE616	0.5	0.5	E-616	
FE617	1	1	E-617-20	
FE621A	0.722	0.73974	E-621-24	
FE621B	1	1	E-621-24	
FE626	0.5	0.5	E-626	
FE627A	0.5	0.50163	E-627-647	

Figure 53. Estimated Values of Plant parameters in Final Report



**Output** File View

5/15/01 4:50:00 PM

**Values of Unmeasured Variables**

Unmeasured Variables	Value From Data Validation	Value From Parameter Estimation	Value From Economic
C10pC623	0.00005	0.00004	
C10pC625	0.0001	0.00007	
C10pC627	0.00028	0.00031	
C10pC629	0.00023	0.00021	
C2C623	0.01728	0.01529	
C2C625	0.01616	0.01527	
C2C627	0.01589	0.01674	
C2C629	0.01623	0.01625	
C3C623	3.32705	3.55403	
C3C625	2.24518	2.63691	
C3C627	1.3514	1.38403	
C3C629	1.5028	1.59183	
C3pC623	1.16149	1.18417	
C3pC625	1.13435	1.21046	
C3pC627	1.15023	1.20767	
C3pC629	1.13028	1.12477	
C4pC623	0.03063	0.02923	
C4pC625	0.04434	0.04028	

Figure 54. Reconciled Values for Unmeasured Variables

**Output** File View

5/15/01 4:50:00 PM

**Data Validation results based on Stream No. = HC32**

Measured Variable	value	Units of Process Variables
THC32	256.44052	K
x7HC32	0.04965	
x5HC32	0.03064	
x4HC32	0.12565	
x3HC32	0.77075	
x1HC32	0.02331	
FHC32	1.86898	metric ton/min

Unmeasured Variable	value	Units of Process Variables
PHC32	102.16379	kPa
xx7HC32	0.03396	
xx5HC32	0.02506	
xx4HC32	0.12753	
xx3HC32	0.78228	
xx1HC32	0.03117	
FmHC32	0.03169	(metric) tonmole/min
hHC32	870.77204	MJ/min

Figure 55. Information based on Stream Number

Clicking on the “Unmeasured Variables”, the system opens a spreadsheet data form which includes the unmeasured variables and their reconciled values as shown in Figure 54.

Three options are available in the ‘Stream Number’ menu as shown in Figure 51. The three options are Data from Data Validation, Data from Parameter Estimation and Optimal Setpoints. Let us click the ‘Data from Data Validation’ option. An input box appears. Let us enter ‘AC09’ and click ‘Ok’. The Measured Variables and Unmeasured variables which are associated with the stream ‘AC09’ with their reconciled values from Data Validation are displayed as shown in Figure 55.

When the ‘Full Output file’ option in the view menu is selected, three buttons are displayed in the toolbar each corresponding to the three optimization problems. Clicking a button will open the corresponding output file for viewing. Let us click on ‘Economic Optimization’ option in the Full output menu. The front part of full output file is shown in Figure 56 and the entire file is shown in Appendix B.

The user can use the ‘Find’ and ‘Goto’ options in the Edit menu to search for a particular phrase or go to a particular section in the Full output file. The Final Report can be exported as Excel files using the ‘Export’ option in the file menu. The Full Output files can also be exported as text files using the ‘Export’ option.

Flowsheet can be viewed in results , in a window similar to the one shown in Figure 46. Double clicking on a stream or unit opens the corresponding data window. The Data window for stream ‘s06’ is shown in Figure 57. As seen in this figure, the values of the measured variables obtained as a result of on-line optimization are displayed in the data window.

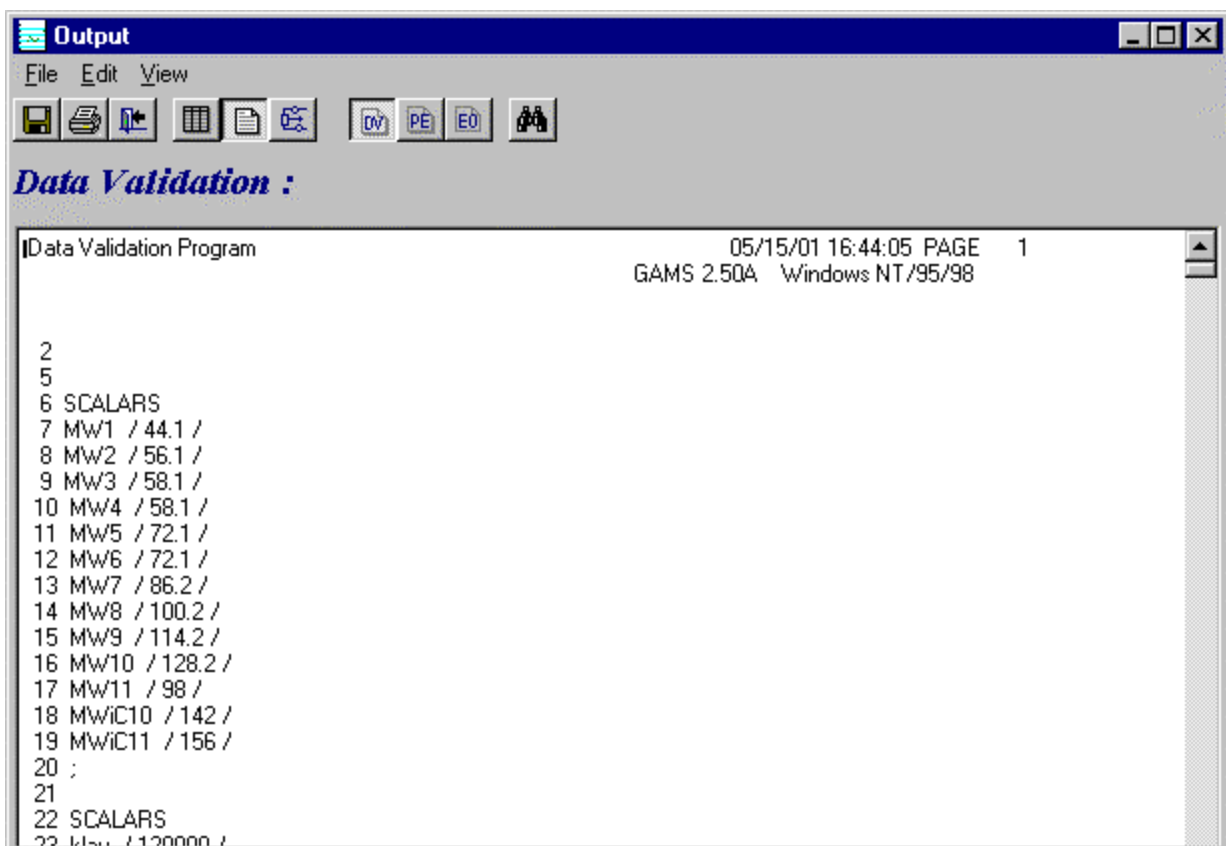


Figure 56. Full Output File of Gams Programs

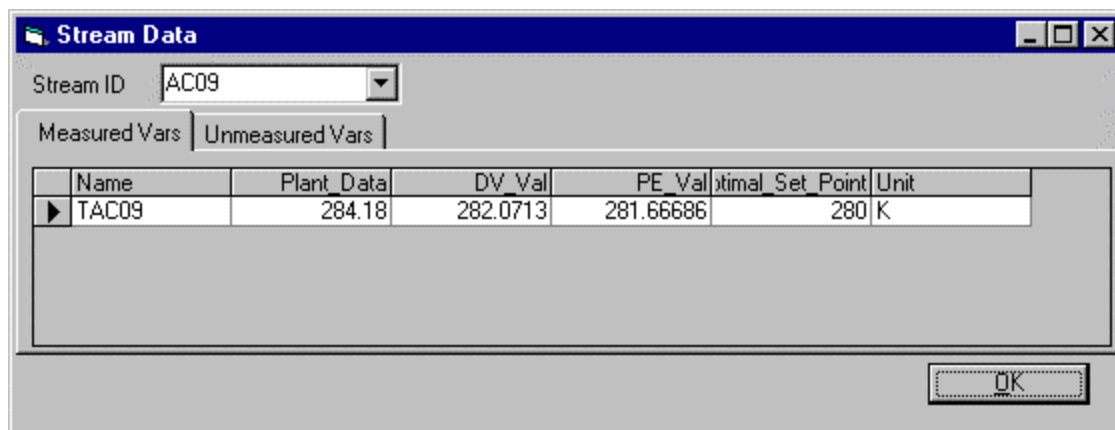
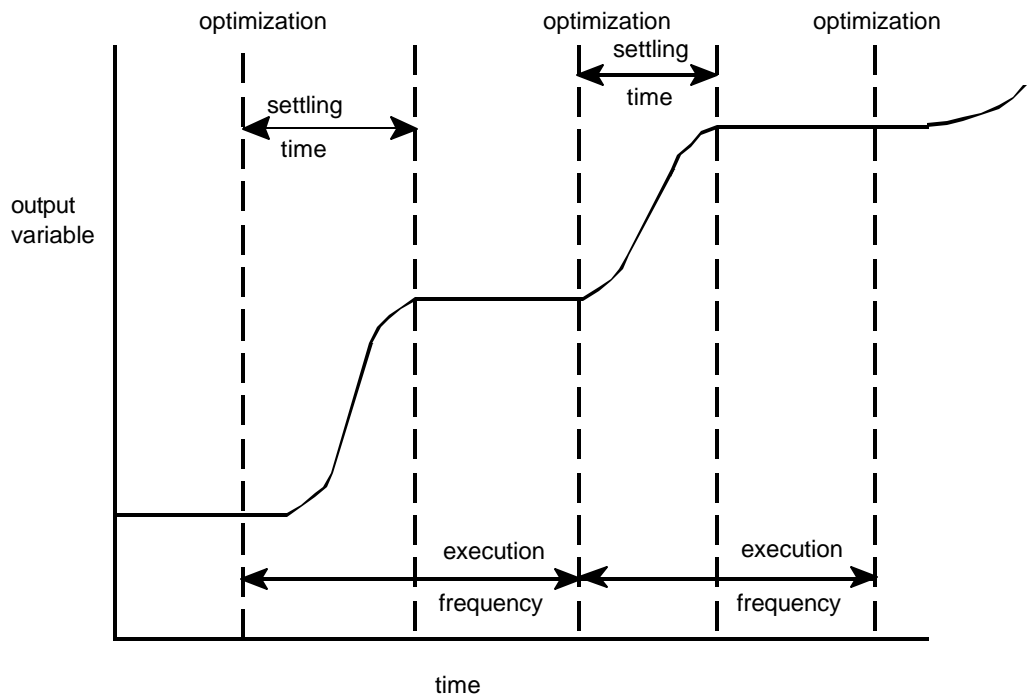


Figure 57. Stream Data Window

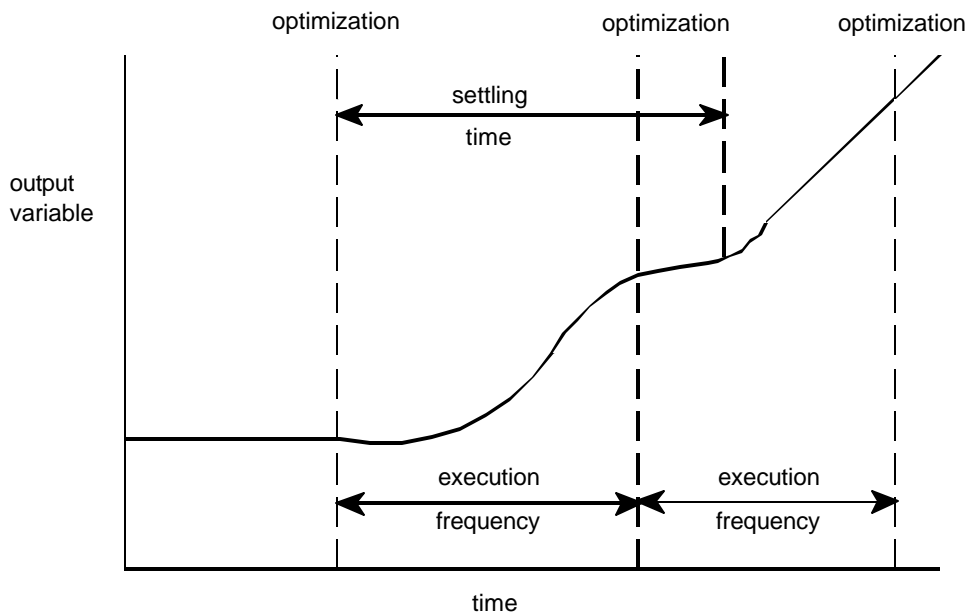
Clicking the 'Close' option in the file menu of the Output window returns the user to the main screen, which was shown in Figure 38. The model information can be exported as Excel files using the 'Export' option in the file menu of the main window. Save the optimization results using the 'Save' option in the file menu. The results including the full output files are stored along with the Alkylation model. When the 'Exit' button is clicked, the Interactive On-line Optimization main window is closed and the user is taken back to the Advanced Process Analysis Desk.

### Steady-State Detection and Execution Frequency

On-line optimization executes economic optimization and generates a set of optimal set point. Then these set points are transferred to the coordinator program or the operators as an Excel spreadsheet file. These optimal set points can be sent directly to Distributed Control System or they can be viewed by operators before they are sent to the DCS. Before the optimal set points are implemented, the steady state detection program is run to ensure the process is at steady state. The following gives detailed information about steady-state detection and execution frequency.



a. Time between optimizations is longer than settling time



b. Time between optimizations is less than settling time

Figure 58. Comparison of Time between Optimizations and Process Settling Time after Darby and White (1988).

The execution frequency for optimization is the time between conducting on-line optimization of the process, and it has to be determined for each of the units in the process. It depends on the settling time, i.e., the time required for the units in the process to move from one set of steady-state operating condition to another. This settling time can be estimated from the time constant determined by process

step testing. The time period between two on-line optimization executions must be longer than the settling time to ensure that the units have returned to steady state operations before the optimization is conducted again. This is illustrated in Figure 58, after Darby and White (1988). The figure shows that execution frequency for optimization in Figure 58a was satisfactory for the process but the execution frequency in Figure 58b was too rapid for the process. In Figure 58a, the process has returned to steady-state operations and held that position until the next optimization. However, in Figure 58b, the process did not have enough time to return to steady-state operations before the optimization altered the operating conditions. The process would continue on an unsteady state path, and operator intervention would be required. The settling time for an ethylene plant is four hours according to Darby and White (1988), and this time for the sulfuric acid contact process is twelve-hour according to Hertwig (1997).

As shown in Figure 58, it is necessary to make sure that the process is operating at steady state before the plant data is taken from distributed control system for conducting on-line optimization. Steady state plant data is required for steady state process models.

The time series horizontal screening method has been used in industry to detect steady state. In this method, the measured values for key process variables are observed for a time period. If the measured values remain within the bounds of two standard deviations, then the process is said to be operating at steady state. This requires the use of a coordinator program or operator action for identifying steady state and exchanging data between the on-line optimization program and the distributed control system. Excel spreadsheet files are widely used to transfer the data. The use of an Excel spreadsheet is the industry standard way of selecting and manipulating data from a DCS. Therefore, the on-line optimization program is capable of importing the identified steady state values for the measured process variables if they are stored in an Excel spreadsheet.

To transfer this steady state data to the on-line optimization program, return to the Declaration Window for Measured Variables, which is shown in Figure 41 and pull down the File menu. This is shown in Figure 60 and then select Import Plant Data. This action brings up the window shown in Figure 61, and in this window the name of the Excel file is designated which contains the steady state plant data that was selected with the Excel time series program. Clicking the Open button will replace the plant data currently in the program. Now having the new data in place, the on-line optimization program can be executed to generate the new set of optimal points for the distributed control system.

The execution of the on-line optimization program generates the set points for the distributed control system. These values can be exported from the on-line optimization program using the same procedure as importing data.

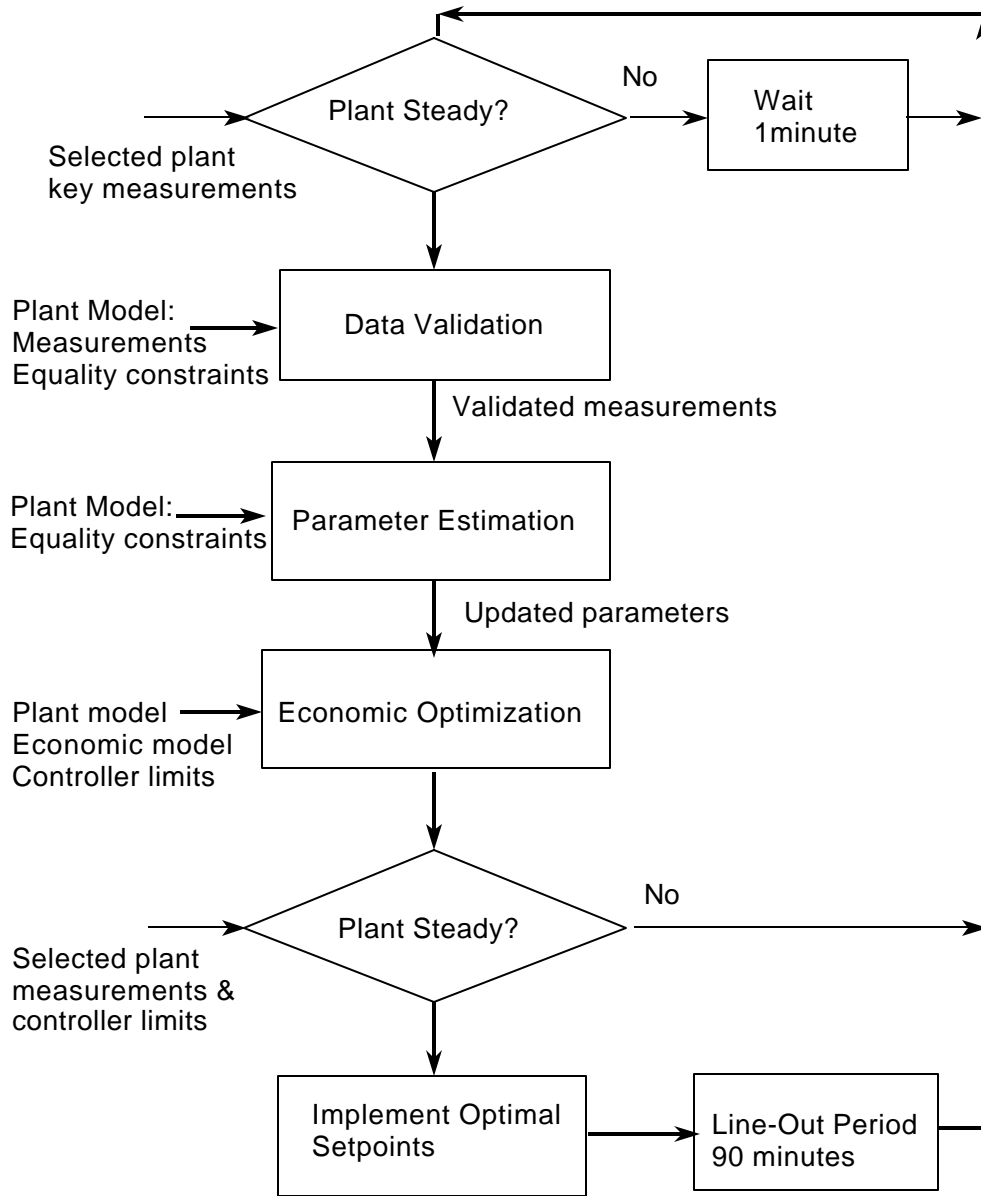


Figure 59. Implementation Procedure for On-Line Optimization, after Kelly, et al. (1996)

The file menu in these windows has a line Export Plant Data which, when clicked, gives a screen similar to the one in Figure 61 to specify the Excel file to transfer this data.

The on-line optimization program requires the standard deviation of the measured variables as shown in Figure 41. This information can be transferred to the on-line optimization program using the same procedure as was used for the measured variables. However, it is not necessary to use the current plant data to evaluate the standard deviation, and the Excel program can be used with any data set to determine appropriate values of the standard deviation.

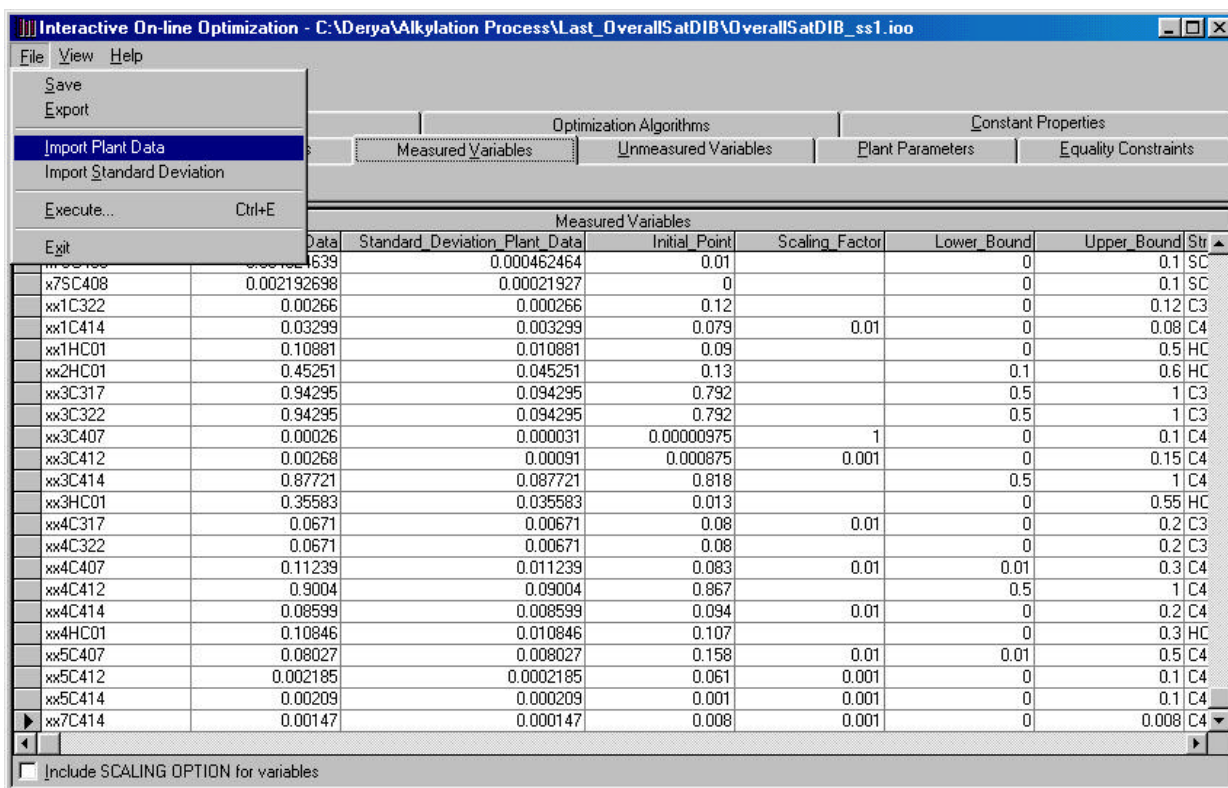


Figure 60. The Import Option in the File menu of On-line Optimization

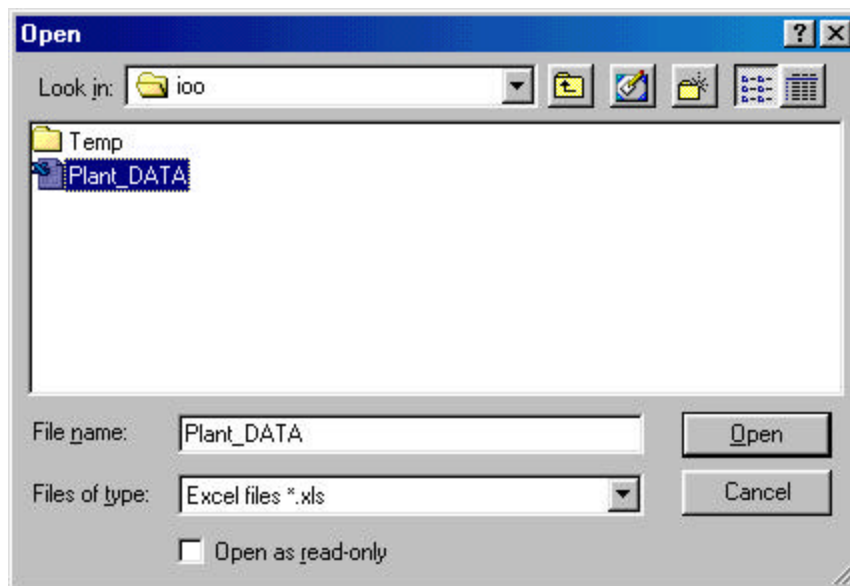


Figure 61. The Dialog Box that opens when Import is clicked

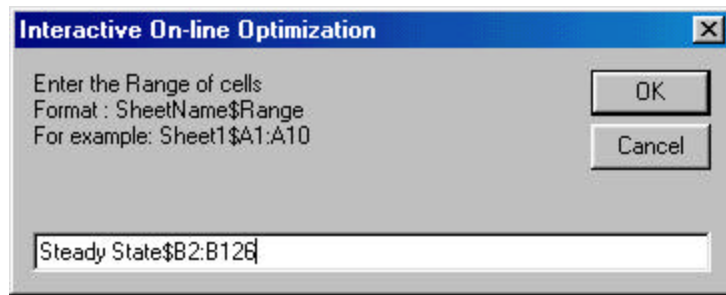


Figure 62. The Screen to enter the Excel Sheet Name and Range

This concludes the description of steady-state detection and execution frequency of on-line optimization. The next step of Advanced Process Analysis System is the heat exchanger network optimization. Click the 'Pinch Analysis' button in Advanced Process Analysis Desk to open the heat exchanger network (THEN) program.

## VII. USING THE HEAT EXCHANGER NETWORK (THEN) PROGRAM

Upon clicking the 'Pinch Analysis' button on the Advanced Process Analysis Desk, the 'Heat Exchanger Network Model Information' window is displayed. This window is shown in Figure 63. Since we are using the THEN program for the first time, click the 'New Model' button.

Once the 'New Model' button is clicked, the 'Welcome Screen' of the Heat Exchanger Network program is displayed. This screen is shown in Figure 64. The message at the center confirms that you are working on the process model 'Alkylation.ioo' in the 'Examples'



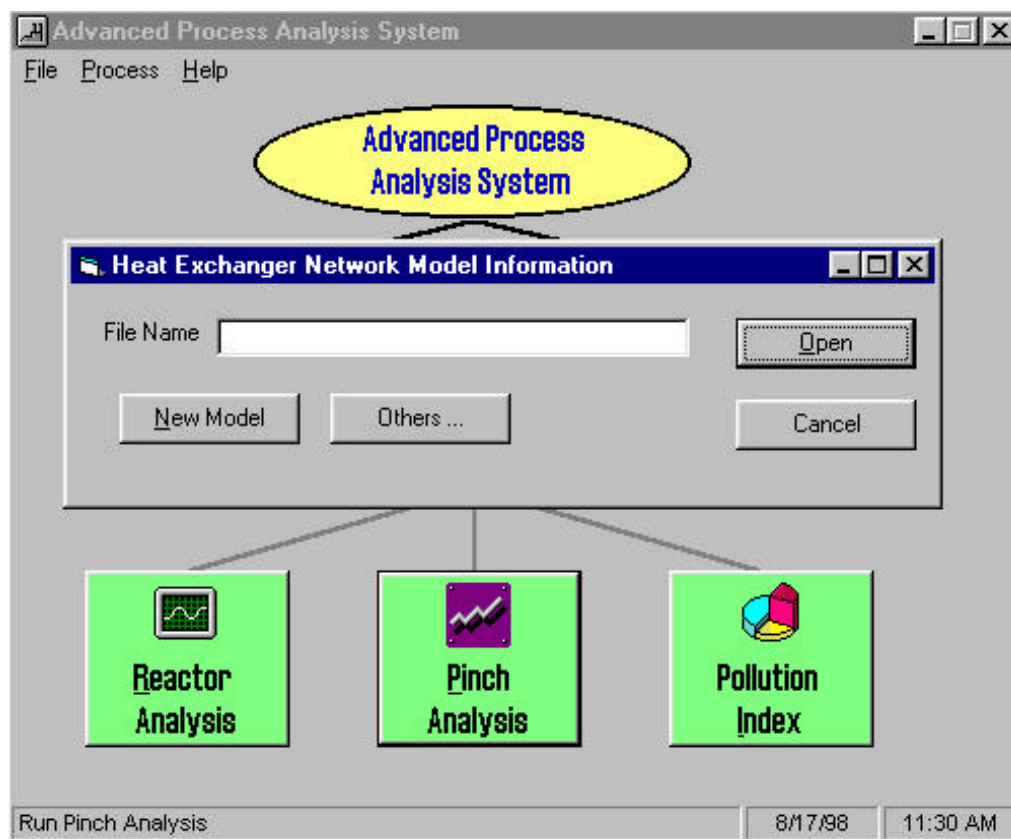


Figure 63. The Heat Exchanger Network Model Information Window

subdirectory. The HEN model you are working on is an untitled new model. A HEN model is an input file created by the heat exchanger network program to apply pinch analysis to the process model. A HEN model is stored as a file with 'hen' extension (e.g. sample.hen).

The menu at the top of the background window is the 'main menu' of THEN. It is available at all times during the execution of the program. The 'Help' button can be used to access online help. The 'About' button gives the copyright information. The 'Exit' button can be used to quit the program at any time and go back to the Advanced Process Analysis Desk.

Click on the 'Proceed' button on the welcome screen. The 'Stream List' window is now displayed on the screen. This is shown in Figure 65. The box in the center shows the list of all the process streams and their descriptions. This list has been automatically retrieved by the program based on the information in the flowsheet diagram. Scroll up and down in the box to see the entire list. There is a check box available to the left of each stream name in the list. If a process stream is important for heat integration, the check box for that stream needs to be selected. For the Alkylation model, the following streams are determined to be important; C306, C307, C308, C309, C312, C315, C316, C317, C318, C319, C323, C324, C325, C326, C401, C402, C403, C404, C405, C406, C407, C408, C409, C410, C411, C412, C413, C414, C415, C418, C419, HC01, HC02, HC03, HC04, HC05, HC29, HC30, SC401, SC402, SC403, SC404, SC405, SC406, SC407, SC408, SC409, SC412, SC413. Select all of these streams in the list by clicking on their checkboxes.

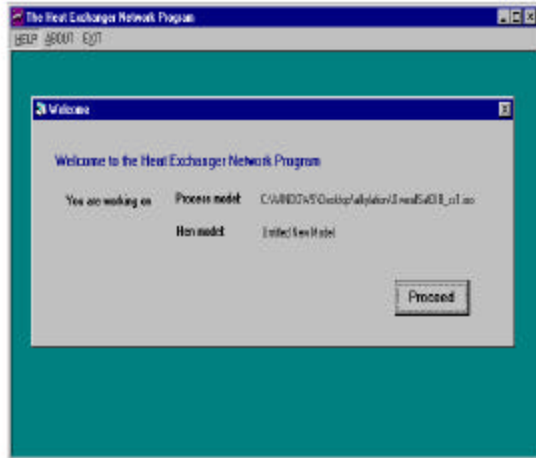


Figure 64. The Welcome Screen of THEN

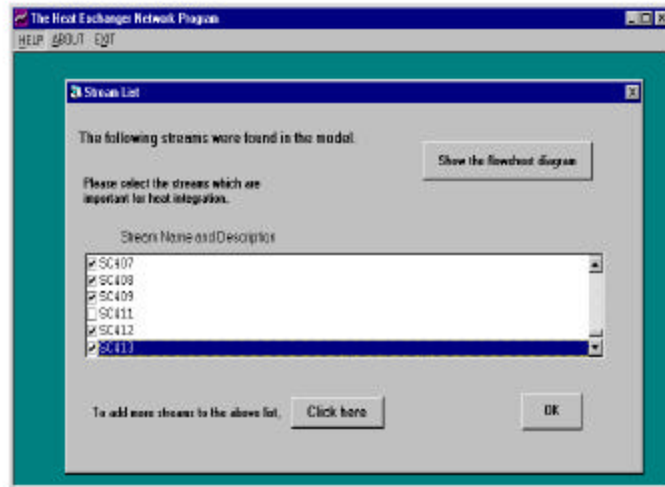


Figure 65. The Stream List Window

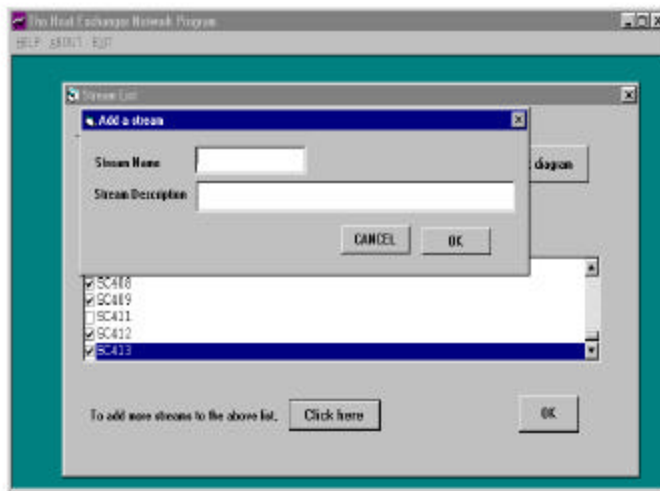


Figure 66. The Add Stream Window

The button ‘Show the flowsheet diagram’ at the top of the stream list window can be used to view the flowsheet diagram at any time. In addition to the streams listed, new streams can also be added. To add a stream, click the ‘Click here’ button at the bottom of the window. A small window shown in Figure 66 is displayed. A stream name and a description must be entered. Clicking the ‘OK’ button will add the stream to the list. For the Alkylation model, we do not want to add any stream. So, click the ‘Cancel’ button to go back to the ‘Stream List’ window.

Having selected all the important streams in the Stream List window, click the ‘OK’ button to continue. The next window displayed on the screen is the ‘Retrieving Stream Data’ window shown in Figure 67. A vertical line divides this window into two parts. The left side of the screen displays a list. This list contains all the streams, which were selected earlier in the ‘Stream List’ window. As can be seen from the Figure 67, all the forty streams that were chosen as the important streams are present in the list.

The heat exchanger network program needs certain information for each stream in order to apply pinch analysis. This information includes temperature, flowrate, enthalpies and film heat transfer coefficient. The values of all of these variables have to be retrieved for each of the selected streams. The values for temperature and flowrate are automatically retrieved by the program from the results of economic optimization carried out earlier during Advanced Process Analysis System. The values for enthalpies and film heat transfer coefficients have to be entered by the user. To understand how the data is retrieved, let us enter the data for the stream C306.

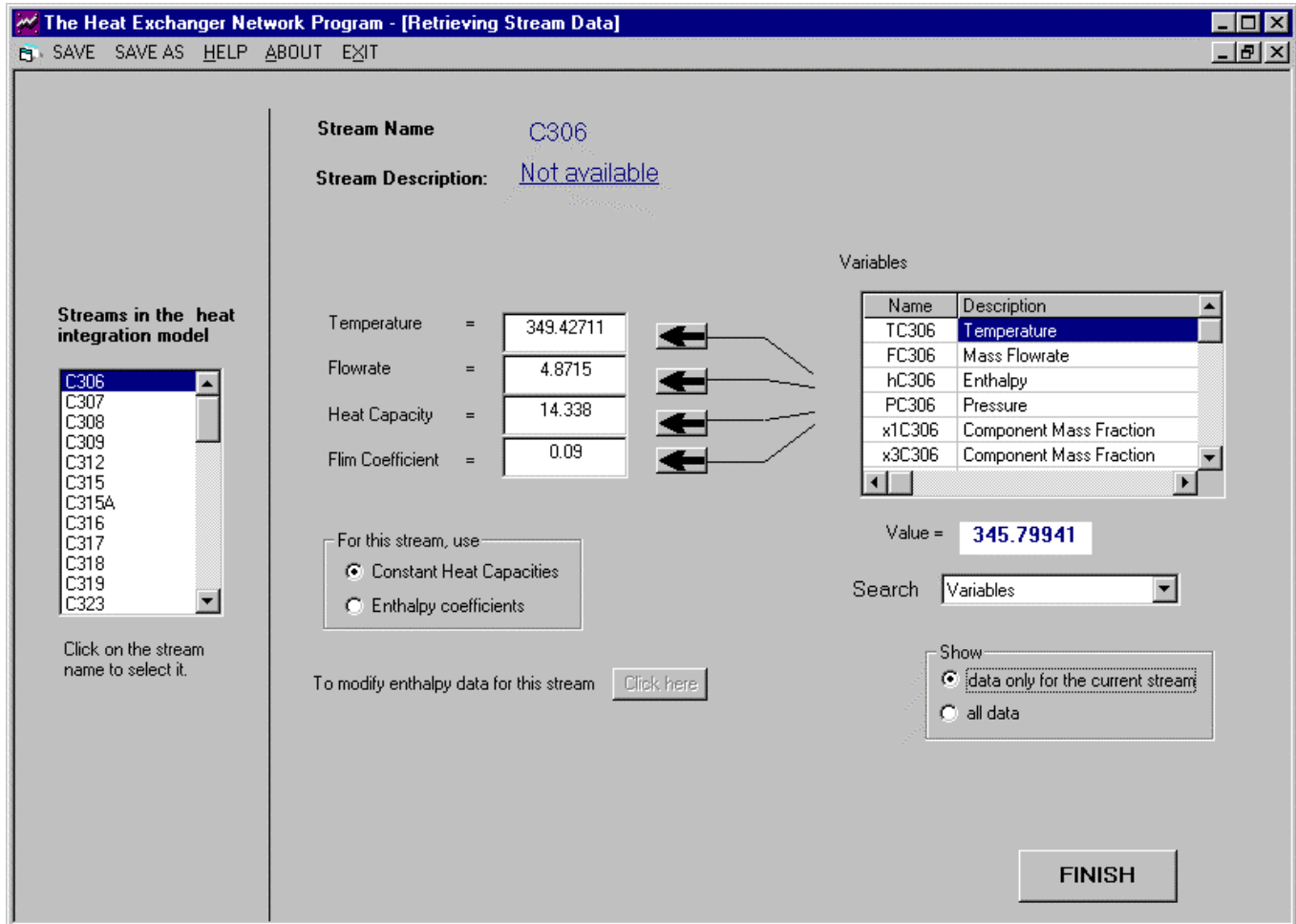


Figure 67. The Retrieving Stream Data Window

Click on the stream C306 in the list on the left side of the screen. On the right side of the screen, the stream name and stream description labels now show 'C306' and 'not Available' respectively. The description of the stream is shown as 'not available' it is no description is given while entering stream details. As can be seen in Figure 67, the temperatures and flowrate values for stream C306 have been automatically retrieved and displayed. The heat capacity and film coefficient values are initialized to the defaults, which are 0 and 100 respectively.

The enthalpy data for any stream can be entered as either constant heat capacity coefficients or temperature-dependent enthalpy coefficients. For the alkylation process constant heat capacity coefficients are used for all the streams. To enter these coefficients for stream C306, select the 'Constant Heat Capacities' option. This view is shown in Figure 67.

Now, the temperature, flowrate and enthalpy coefficients data for stream C306 have been entered and can be seen in the Figure 67. The final piece of information is the film heat transfer coefficient value. For the Alkylation process model, an average film coefficient value of  $0.09 \text{ MJ/m}^2\text{-K.min}$  is estimated for all the process streams. Change the default value of 100 to 0.09 as the film coefficient for stream C306. This completes the data retrieval for stream C306.

This procedure should be repeated for all the streams listed on left side of the screen. For each of the streams, the temperature and flowrate will be automatically retrieved. The enthalpy coefficients should be calculated as done for stream C306. The film heat transfer coefficient values for all the streams should be 0.09. The data retrieval part for Alkylation model is now complete and the 'Finish' button at the bottom of the screen should now be clicked.

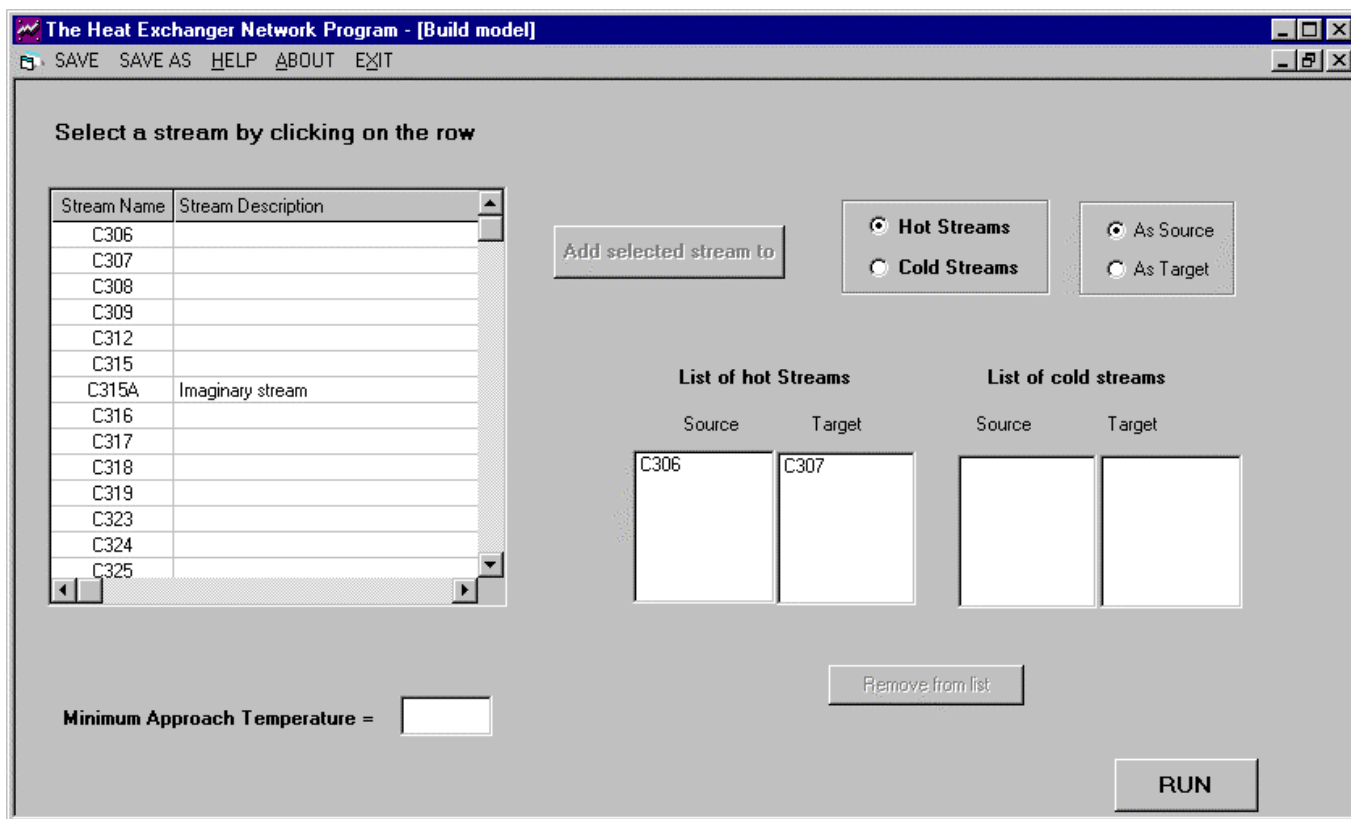


Figure 68. The Build Model Window

When the 'Finish' button is clicked, the 'Build Model' window appears on the screen. This is shown in Figure 68. In this 'Build Model' window, the final step of dividing process streams into pairs of hot and cold streams is performed. This classification of streams constitutes the THEN model. In a THEN model, a hot stream is a stream that needs to be cooled and a cold stream is a stream that needs to be heated.

The table on the left side of the screen shows the list of process streams selected earlier in the program for heat integration. It shows the stream names as well as the descriptions. The two pairs of lists on the right side of the screen display the hot and cold streams in the stream model. Let us build the stream model for the Alkylation process.

From our knowledge of the Motiva Alkylation process, we know that stream C306 enters the refrigerant partial condenser and the stream C307 is the outlet stream from the condenser. Therefore, streams C306 and C307 are the source and targets respectively of a hot stream. To enter the hot stream, first select the stream C306 in the table. The button 'Add selected stream to' now becomes enabled. Select the 'Hot Streams' option and the 'As source' option. Now click the 'Add selected stream to' button. The stream C306 gets added to the list of hot streams as the source. Now click on the stream C307 in the table. Keep the 'Hot Streams' option and select 'As target' option this time. Now, C306 and C307 are both added to the hot streams list as source and target respectively. These two constitute one hot stream. The screen view now is shown in Figure 68.

Repeat this procedure for all the other streams. The hot stream pairs for the Alkylation process are C306-C307, C308-C309, C312-C315A, C317-C318, C318-C319, C325-C326, C405-C406, C406-C407, C412-C413, C414-C415, C418-C419, HC01-HC02, HC03-HC04, HC04-HC05, SC403-SC404, SC404-SC405, SC408-SC409 and SC412-SC413. The cold stream pairs are C315-C316, C323-C324, C401-C402, C402-C403, C403-C404, C408-C409, C410-C411, HC29-HC30, SC401-SC402 and SC406-SC407. In all of these pairs, the first stream is the source and the second stream is the target. Once, we have entered all of these streams, the THEN model for the Alkylation process is complete. The 'Build Model' window with all the hot and cold streams is shown in Figure 69. The last piece of information needed is the minimum approach temperature between the streams. There is no fixed recommended value for this. We will enter an approach temperature of 13 °C to ensure that there is sufficient driving force for heat exchange between the streams.

The input part of the program is now over. Let us save the information entered so far by clicking the 'Save' button. The program displays the 'Save As' window shown in Figure 70. Save the model as 'Alkylation.hen' in the 'Examples' subdirectory of the program folder.

Now, click the 'Run' button on the 'Build Model' window. The program uses all of the information entered above and applies concepts of pinch analysis to the Alkylation process. The next window that appears on the screen is the 'Output Window' shown in Figure 71.

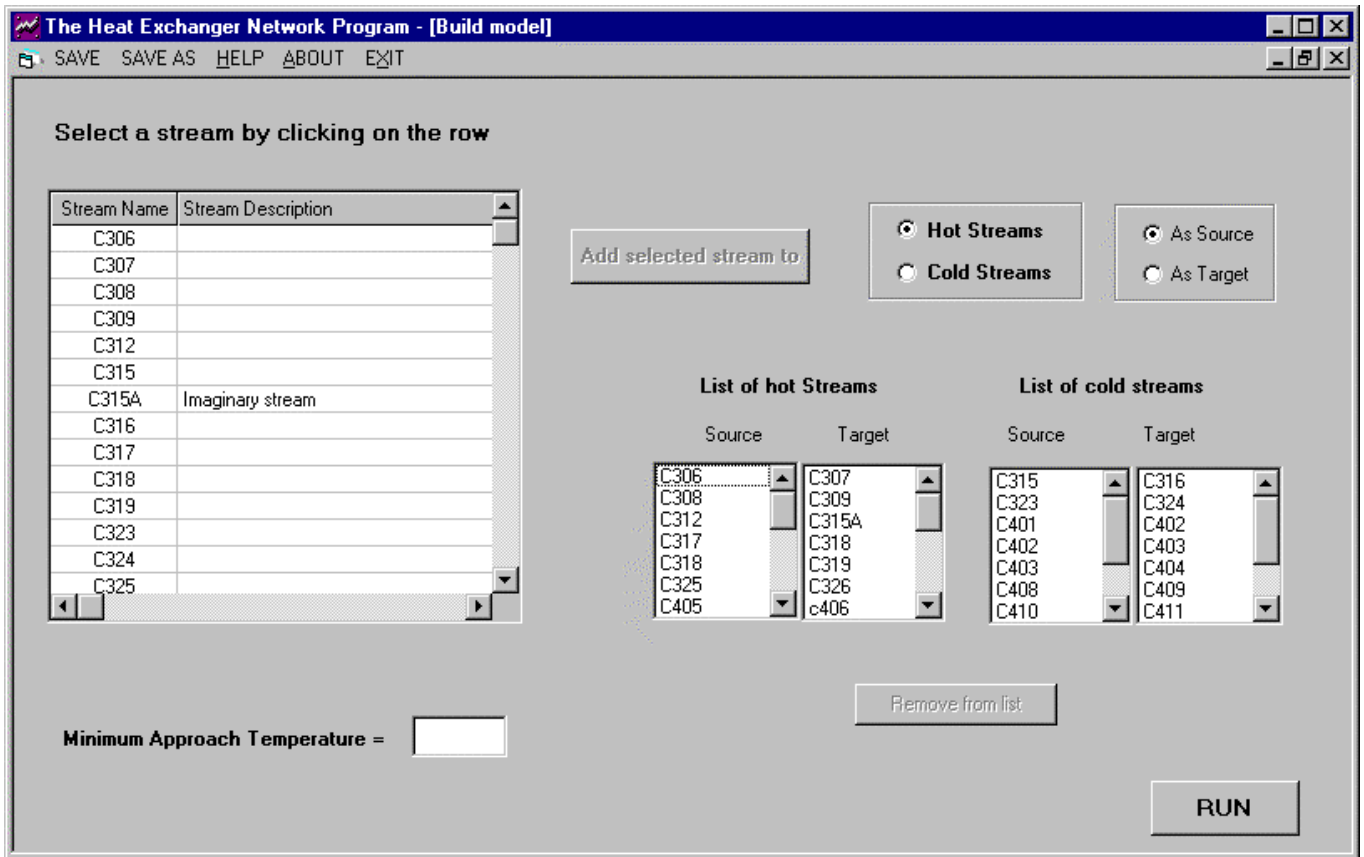


Figure 69. The Build Model Window with all the Hot and Cold Streams

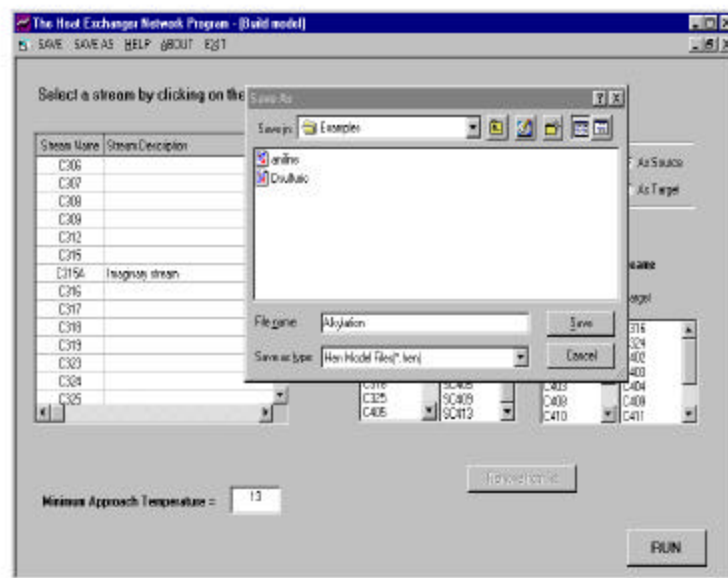


Figure 70. The Save As Window

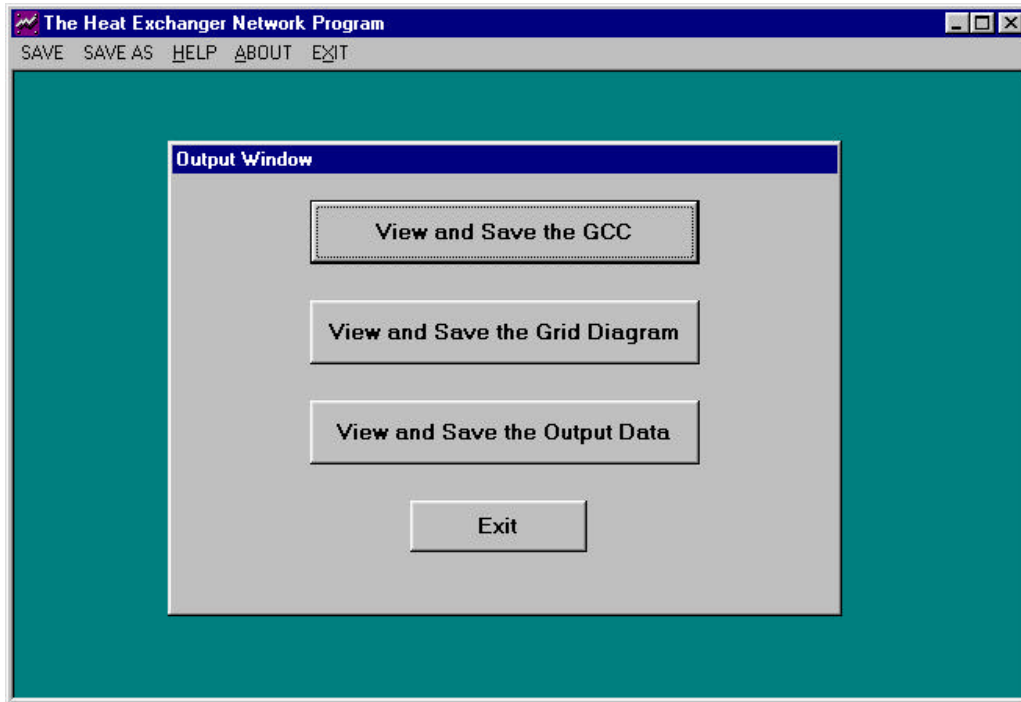


Figure 71. The Output Window

Clicking the first button 'View and save the GCC' on the 'Output Window' displays the 'Grand Composite Curve' on the screen. This is shown in Figure 72. It is a plot of enthalpy flows in the system versus temperature. The units for temperature and enthalpy are the same as for the input data entered. The temperatures are in Kelvin and enthalpies are in KJ/s. As seen in Figure 72, the curve touches the temperature-axis at 343.113 K. The amount of cold utility is the enthalpy coordinate of the lowest point of the curve. This is about 4000 MJ/min as seen in the diagram. The amount of hot utility is the enthalpy coordinate of the highest point of the curve. This is about 1700 MJ/min as seen in the diagram. The exact amounts of the hot and cold utilities can be seen in the output file, which is explained later.

The menu bar at the top of the diagram provides options for viewing and printing the diagram. Clicking the 'View' button displays the commands to turn off the grid and show the data points. The 'Print Options' button can be used to set the number of copies and change the printer orientation. Clicking the 'Print' button will print the diagram to the default system printer. Click the 'Save' button to save the diagram in 'Windows Metafile' format. The 'Help' button will display a brief description about the Grand Composite Curve. Closing the window brings the user back to the 'Output Window'.



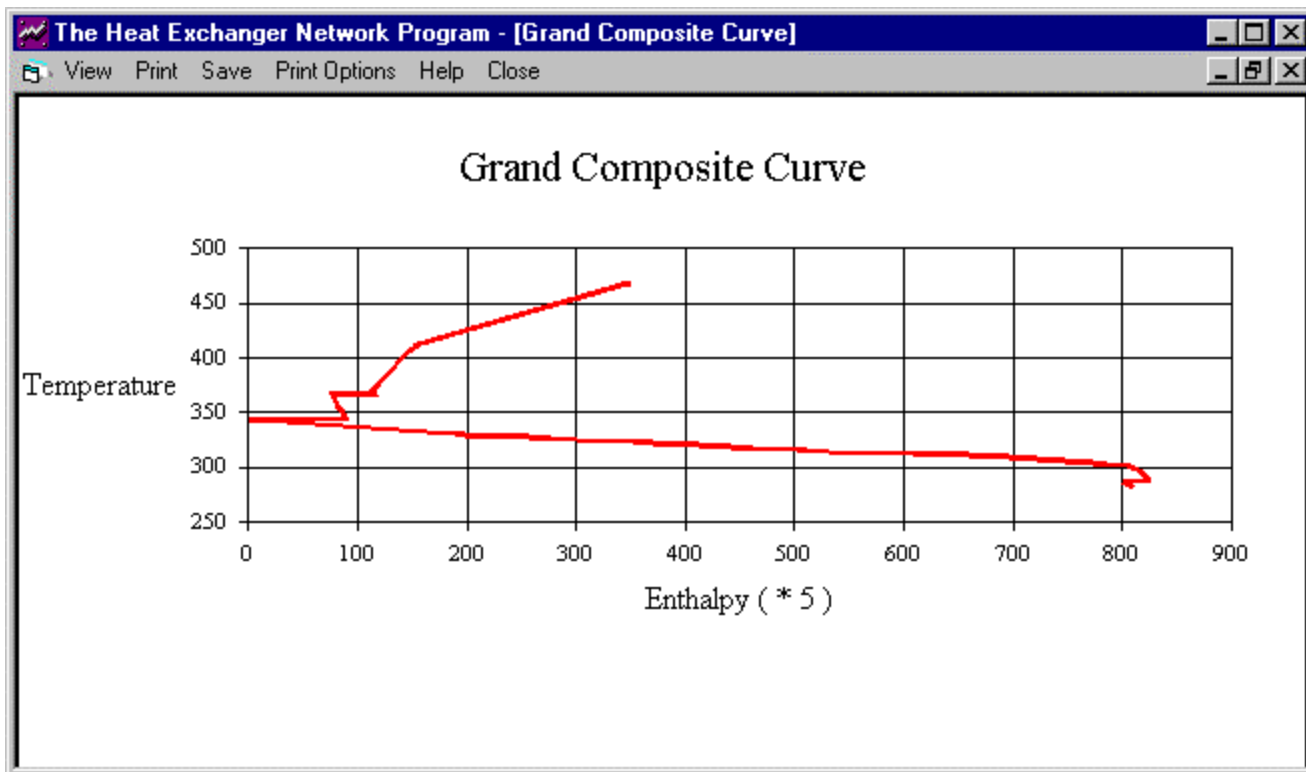


Figure 72. The Grand Composite Curve

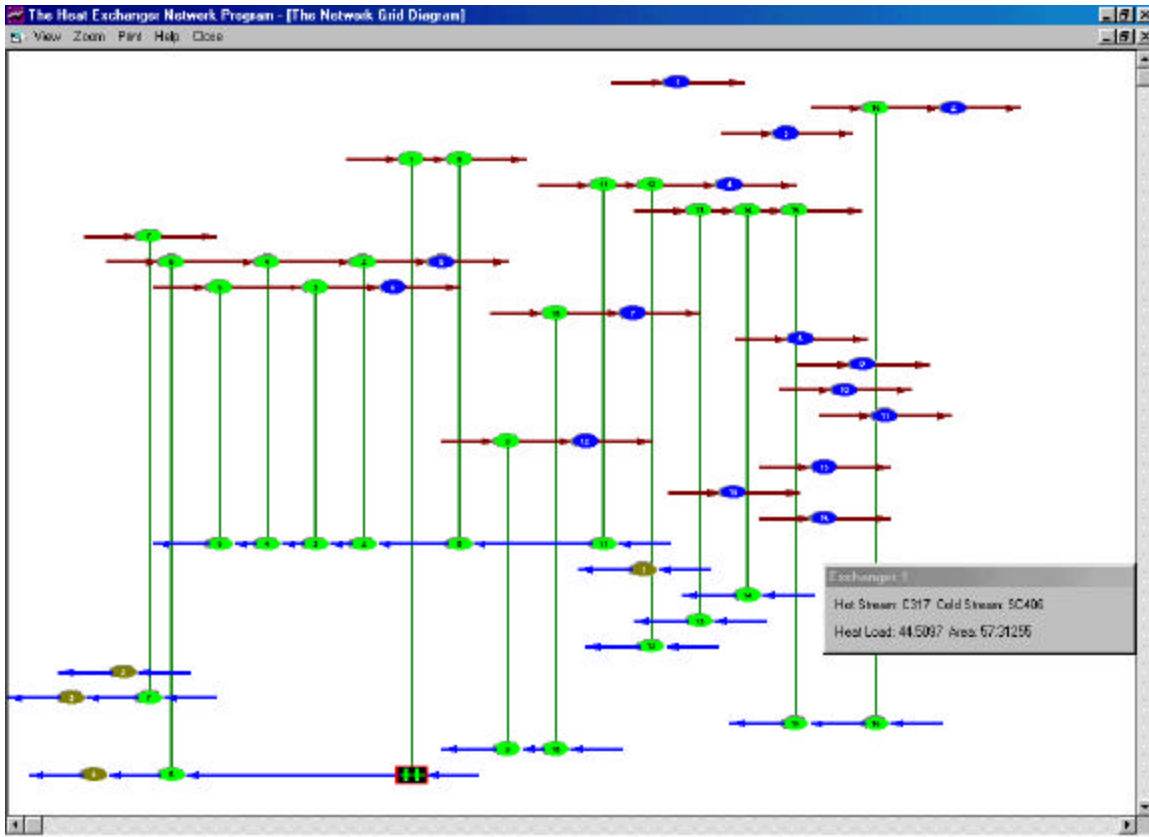


Figure 73. The Network Grid Diagram

The second button 'View and save the Grid Diagram' on the 'Output Window' displays the 'Network Grid Diagram'. This is shown in Figure 73. It is a graphical representation of the network solution designed by the program. It shows the arrangement of heat exchangers, heaters and coolers in the system. Red lines going from left to right represent hot streams and blue lines going from right to left represent cold streams. A red circle on a blue line means a heater and a blue circle on a red line is a cooler. Green circles joined by a vertical green line represent a heat exchanger between the streams on which the two circles lie

The network grid diagram offers a very convenient way of understanding the solution network. Clicking on a unit in the diagram displays a small box, which shows all the necessary information for that unit. For example, clicking on a green circle will display the relevant information for the heat exchanger that it represents. This information includes the names of the hot and cold streams flowing through it, the heat exchange load of the exchanger and its area. Clicking on a heater or a cooler will show the name of the stream flowing through it and its heat load. Similarly, clicking on a horizontal line will display the temperature, mass flowrate and average heat capacity of that stream. In Figure 73, the heat exchanger with index 1 has been selected by clicking, and the box at the bottom right side is showing the information for that heat exchanger.

Information about the grid diagram can be obtained as online help by clicking the 'Help' button in the menu bar at the top of the diagram. Other buttons in the menu bar are to set the view and print options. The 'Zoom' button allows the user to change the zoom of the diagram. The 'View' button can be

used to display the printer lines. The 'Print' button will open the printer dialog box and print the diagram to the selected printer. Closing the window will take the user back to the 'Output Window'.

The screenshot shows a window titled "The Heat Exchanger Network Program: [Output Data]". The window has a menu bar with "SAVE", "SAVE AS", "HELP", "ABOUT", and "EXIT". Below the menu bar are three buttons: "SAVE", "CLOSE", and "PRINT". The main content area displays the following text:

```

HEAT EXCHANGER NETWORK SYNTHESIS
-----
DETAILS OF HOT STREAMS
-----
ST NAME  FLOWRATE  WCP  INLET T  OUTLET T  FILM COEFFICIENT
-----
C306     4.9       14.3  349.4    328.4     .1
C308     3.1       2.6   328.4    323.0     .1
C312     1.8       16.8  328.4    307.4     .1
C317     1.7       2.0   359.1    322.0     .1
C318     1.7       2.7   322.0    300.0     .1
C325     8         287.6  322.6    321.8     .1
C405     .9        2.7   410.0    389.1     .1
C406     .9        2.5   389.1    303.6     .1
C412     .0        7.1   363.3    301.0     .1
C414     3.0       12.7  337.1    307.3     .1
C418     3.1       2.5   307.1    304.5     .1
HC01     .9        2.2   296.3    292.6     .1
HC03     3.2       2.5   304.2    296.1     .1
HC04     3.2       2.4   296.1    288.2     .1
SC403    .3        2.6   336.6    331.6     .1
SC404    .3        2.6   331.6    300.0     .1
SC408    1.5       104.2  318.8    317.8     .1
SC412    .1        2.5   318.8    300.0     .1
-----

```

Figure 74. The Output Data Window

The third button in the output window, the 'View and save the Output Data' button shows the output text file in a window as shown in Figure 74. Using horizontal and vertical scroll bars, the user can see the entire output text. The 'Print' button at the top of the window prints output file to the default printer. On clicking the 'Save' button, the program opens the 'Save as' window and requests the user to specify the filename. Let us save the output as file 'out.dat' in the Examples subdirectory of the program folder. Click the 'Close' button to go back to the Output Menu window.

The execution of the THEN program is complete. The results have been displayed in the form grand composite curve, network grid diagram and the output data file. Let us look at the results more closely and interpret the solution generated by THEN.

## Using the Results from THEN

The Grand Composite Curve (GCC): The GCC for the Alkylation process is shown in Figure 72. It is a plot of temperature on Y-axis versus the enthalpy flow on X-axis. If the curve touches the temperature-axis except at its endpoints, it is a pinched process, and the temperature corresponding to that point is the pinch temperature. If the curve touches the X-axis at its uppermost point, the process is 'below the pinch'. If it touches at the lowermost point, it is an 'above the pinch' process. In Figure 72, the GCC meets the temperature axis at 343.113 K. Hence it is a pinched process.

Also, the GCC can be used to determine the minimum amount of hot and cold utilities needed by the process. To find the amount of hot utility required, locate the topmost point of the curve and read its X coordinate which is equal to the amount of hot utility. Similarly, to get the amount of cold utility required, locate the bottommost point of the curve and read its X coordinate. For the Alkylation process, from Figure 72, it can be seen that the amount of hot utility is 1800 MJ/min and the amount of cold utility is about 4000 MJ/min.

### **The Network Grid Diagram:**

The network grid diagram for the Alkylation process is shown in Figure 73. Let us examine this diagram to understand the new heat exchanger network structure for this process. The 18 horizontal red lines at the top running from left to right represent the hot streams C306, C308, C312, C317, C318, C325, C405, C406, C412, C414, C418, HC01, HC03, HC04, SC403, SC404, SC408 and SC412. The 10 horizontal blue lines at the bottom running from right to the left represent the cold streams C315, C323, C401, C402, C403, C408, C410, HC29, SC401 and SC406. The blue circles (numbered 1-15) on streams indicate that these streams require coolers. The red circles (numbered 1-4) in the diagram indicate the presence of heaters. There are 16 pairs of green circles (numbered 1-16) joined by vertical green lines. These represent the 16 heat exchangers in the process. Each exchanger exchanges heat between the two streams on which the two circles lie. For example, heat exchanger 1 (the pair of green circles with number 1) is exchanging heat between the hot stream C317 and cold stream SC406. Thus, it can be seen from the grid diagram that the Alkylation process needs 16 heat exchangers, 4 heaters and 15 coolers in the new network solution.

### **The Output Data File:**

Now, let us examine the output data generated by THEN. The complete output file for the above problem is given in Table VII.1. In Table VII.1, the first two sections 'Details of hot stream' and 'Details of cold stream' list a summary of the input information entered by the user. This consists of the data for hot and cold streams followed by the specified minimum approach temperature for the matches. The input summary is followed by the results for the simple process.

This is followed by a matrix of values which is the solution array generated by THEN for the problem above the pinch. These values can help in understanding the matches made by the program to arrive at the solution. However, the most important part of the output is the Heat Exchangers, Heaters and Coolers summary tables, which follow.

The heat exchanger summary above the pinch shows that there should be 7 heat exchangers, each between streams SC406-C317, C315-C406, C315-C412, C315-C406, C315-C412, SC406-C406, C410-C405. For exchanger 1 between SC406 and C317, the heat transfer rate will be 44.5 MJ/min. Also, it gives the inlet and outlet temperatures for both the streams. Note that the area of the heat exchanger (57.313 m<sup>2</sup>) has been calculated using the film heat transfer coefficient supplied in the data.

Table VII.1. THEN Solution for the Alkylation Process - Output Data File

HEAT EXCHANGER NETWORK SYNTHESIS					
-----					
DETAILS OF HOT STREAMS					
-----					
ST NAME	FLOWRATE	MCP	INLET T	OUTLET T	FILM COEFFICIENT
=====					
C306	4.9	14.3	349.4	328.4	.1
C308	3.1	2.6	328.4	323.0	.1
C312	1.8	16.8	328.4	307.4	.1
C317	1.7	2.8	359.1	322.0	.1
C318	1.7	2.7	322.0	300.0	.1
C325	.8	287.6	322.6	321.8	.1
C405	.9	2.7	410.0	389.1	.1
c406	.9	2.5	389.1	303.6	.1
C412	.0	7.1	363.3	301.0	.1
C414	3.0	12.7	337.1	307.3	.1
C418	3.1	2.5	307.1	304.5	.1
HC01	.9	2.2	296.3	292.6	.1
HC03	3.2	2.5	304.2	296.1	.1
HC04	3.2	2.4	296.1	288.2	.1
SC403	.3	2.6	336.6	331.6	.1
SC404	.3	2.6	331.6	300.0	.1
SC408	1.5	304.2	318.8	317.8	.1
SC412	.1	2.5	318.8	300.0	.1
=====					

DETAILS OF COLD STREAMS  
-----

```

=====
ST NAME      FLOWRATE      MCP      INLET T  OUTLET T      FILM COEFFICIENT
=====
C315         1.8           2.7      307.4    345.2         .1
C323         .8           237.6    359.1    360.1         .1
C401         2.4           2.3      282.6    283.9         .1
C402         2.4           2.3      283.9    295.8         .1
C403         2.4           2.3      295.8    305.2         .1
C408         3.2           5.4      405.0    461.0         .1
C410         .9            8.2      363.3    403.8         .1
HC29         1.2          111.1    280.0    281.0         .1
SC401        .5            2.6      319.6    323.2         .1
SC406        1.5          306.9    336.6    337.6         .1
=====

```

MINIMUM DELTA T FOR THE MATCHES IS 13.00 DEG

PINCH LOCATED  
PINCH TEMPERATURE = 343.112700

ALL STRMS EXHAUSTED

.0	.0	.0	.0	10.0	1.0	1.0	2.0	6.0	7.0
.0	.0	.0	.0	451.3	2.4	2.3	190.4	17.3	7.0
.0	.0	.0	.0	343.3	358.4	344.9	365.6	411.5	377.3
.0	.0	.0	.0	349.6	.0	.0	190.4	969.8	232.3
4.0	4.7	352.6	.0	44.5	.0	.0	.0	.0	.0
8.0	2.4	382.6	.0	57.2	33.7	.0	.0	.0	.0
9.0	.3	356.8	.0	.0	.0	.0	.0	.0	.0
7.0	2.5	403.5	.0	.0	.0	.0	.0	.0	52.4

HEAT EXCHANGER SUMMARY ABOVE THE PINCH

```

=====
HEX  CS    HS      HEAT  THIN  THOUT  TCIN  TCOUT  CPH    CPC    AREA
=====
1.  SC406  C317    .445E+02  359.07  349.61  336.61  336.71    .47E+01    .45E+03    57.313
2.  C315   c406    .236E+01  350.61  349.61  336.61  337.61    .24E+01    .24E+01     4.040
3.  C315   C412    .230E+01  357.31  349.61  336.61  337.61    .30E+00    .23E+01     3.176
4.  C315   c406    .337E+02  364.88  350.61  337.61  351.88    .24E+01    .24E+01    57.652
5.  C315   C412    .180E+01  363.33  357.31  337.61  338.39    .30E+00    .23E+01     1.800
6.  SC406  c406    .572E+02  389.08  364.88  336.71  336.84    .24E+01    .45E+03    32.604
7.  C410   C405    .524E+02  410.00  389.08  363.33  370.77    .25E+01    .70E+01    45.467
=====

```

HEATER SUMMARY ABOVE THE PINCH

```

=====
HEATER    CNO      HEAT    TCIN    TCOUT    CPC
=====
1.0        2.0      190.4    359.1    360.1    190.4
2.0        6.0      969.8    405.0    461.0     17.3
3.0        7.0      232.3    370.8    403.8     7.0
4.0       10.0      349.6    336.8    337.6   451.3
=====

```

ALL STRMS EXHAUSTED

```

.0    .0    .0    .0    1.0    3.0    4.0    5.0    8.0    9.0
.0    .0    .0    .0    4.7    5.4    5.4    5.5    136.7  1.2
.0    .0    .0    .0    313.9  289.1  290.4  302.3  286.5  326.1
.0    .0    .0    .0    .0     .0     .0     .0     .0     .0
4.0   4.7  315.5    .0   130.2    .0     .0     .0     .0     .0
8.0   2.4  343.1  108.8    .0     .0     .0     .0     .0     .0
9.0   .3  343.1   14.5    .0     .0     .0     .0     .0     .0
1.0  69.8  342.9  1468.5    .0     .0     .0     .0     .0     .0
2.0   8.1  319.4   23.9    .0     .0     .0     .0    20.1    .0
3.0  29.4  321.9  619.3    .0     .0     .0     .0     .0     .0
5.0   4.5  302.5   40.6    6.3     .0     .0    52.1     .0     .0
6.0  235.3  315.3    .0     .0    7.1   64.5     .0   116.6    .0
10.0  38.0  330.5  1130.5    .0     .0     .0     .0     .0    3.0
11.0   7.8  300.6   20.6    .0     .0     .0     .0     .0     .0
12.0   1.9  289.8    7.1     .0     .0     .0     .0     .0     .0
13.0   8.0  297.7   64.9    .0     .0     .0     .0     .0     .0
14.0   7.9  289.6   62.0    .0     .0     .0     .0     .0     .0
15.0   .8  328.7    3.0     .0     .0     .0     .0     .0     .0
16.0   .8  325.1   25.4    .0     .0     .0     .0     .0     .0
17.0  447.3  312.3  447.3    .0     .0     .0     .0     .0     .0
18.0   .4  312.3    6.8     .0     .0     .0     .0     .0     .0

```

HEAT EXCHANGER SUMMARY BELOW PINCH

```

=====
HEX  CS    HS      HEAT  THIN  THOUT  TCIN  TCOUT   CPH    CPC   AREA
=====
  8. C315  C317   .130E+03  349.61  321.95  308.72  336.61   .47E+01   .47E+01   20.532
  9. SC401 SC403   .120E+01  336.61  335.15  322.15  323.17   .82E+00   .12E+01    2.017
10. SC401 C414   .300E+01  337.09  337.01  319.60  322.15   .38E+02   .12E+01    4.133
11. C315  C318   .633E+01  321.95  320.55  307.36  308.72   .45E+01   .47E+01   10.639
12. C403  C318   .521E+02  320.55  309.00  295.81  305.25   .45E+01   .55E+01   81.476
13. C402  C325   .645E+02  322.60  322.33  283.92  295.81   .24E+03   .54E+01   44.466
14. C401  C325   .713E+01  322.33  322.30  282.60  283.92   .24E+03   .54E+01    4.056
15. HC29  C325   .117E+03  322.30  321.80  280.15  281.00   .24E+03   .14E+03   62.499
16. HC29  C308   .201E+02  328.40  325.93  280.00  280.15   .81E+01   .14E+03    9.486
=====

```

COOLER SUMMARY BELOW THE PINCH

```

=====
COOLER  CNO      HEAT  THIN  THOUT   CPH
=====
   1.0    1.0    1468.5  349.4  328.4   69.8
   2.0    2.0     23.9  325.9  323.0    8.1
   3.0    3.0    619.3  328.4  307.4   29.4
   4.0    5.0     40.6  309.0  300.0    4.5
   5.0    8.0    108.8  349.6  303.6    2.4
   6.0    9.0     14.5  349.6  301.0    .3
   7.0   10.0   1130.5  337.0  307.3   38.0
   8.0   11.0     20.6  307.1  304.5    7.8
   9.0   12.0     7.1  296.3  292.6    1.9
  10.0   13.0     64.9  304.2  296.1    8.0
  11.0   14.0     62.0  296.1  288.2    7.9
  12.0   15.0     3.0  335.2  331.6    .8
  13.0   16.0     25.4  331.6  300.0    .8
  14.0   17.0    447.3  318.8  317.8   447.3
  15.0   18.0     6.8  318.8  300.0    .4
=====

```



```

=====
LOOP#           HEAT EXCHANGERS INVOLVED
=====
1               5 3
2               4 1 6 8
5               2 1 6 8
=====

THE MINIMUM HOT UTILITY REQUIREMENT IS:    1742.152000
THE MINIMUM COLD UTILITY REQUIREMENT IS:    4043.175000

```

Next comes the heater summary above the pinch. It shows that we need 4 heaters in the system, for streams C323, C408, C410 and SC406. The heat load for the heater on the stream C323 is 190.4 MJ/min. Stream C323 enters the heater at 359 K and leaves at 360 K and as vapor. Similarly, the other heaters have heat loads of 969.8, 232.3 and 349.6 MJ/min respectively.

The heat exchanger summary below the pinch shows that there should be 9 heat exchangers (numbered 8-16). The cooler summary below the pinch describes the 15 coolers required for the heat integration of the Alkylation Process.

Next comes the information about the loops identified in the network. A loop is any path in the heat exchanger network that starts at some point and returns to the same point. For the Alkylation process, there are three loops in the network.

Finally, the last two lines of output give the minimum hot and cold utilities needed for this process. Thus, for the Alkylation process, 4043.175 MJ/min of heat needs to be removed by use of external cold utilities. The hot utility requirement for the process is 1742.152 MJ/min.

Note that just above the printout of the solution array is a message which says if all the streams were exhausted or not. If the message is 'all streams exhausted', THEN has successfully generated the heat exchanger network. If the message is 'Error- not all streams exhausted', THEN has failed to solve the problem. In this case, the order of the streams in the input data should be changed. For example, the data for stream C408 should be entered before stream C306. The program uses a solution method that is sensitive to the order in which the stream data is entered.

To summarize, the Alkylation process is a "pinched" process, and it needs 16 heat exchangers, 4 heaters and 15 coolers for maximum energy utilization. The minimum amount of cold utility is 4043.175 MJ/min and the minimum amount of hot utility is 1742.15 MJ/min.

This concludes the implementation of the Heat Exchanger Network program in the Advanced Process Analysis System. The next step of the Advanced Process Analysis System is calculation of pollution indices. Click on the 'Pollution Index' button in the Advanced Process Analysis Desk to call the pollution index program.

## VIII. USING THE POLLUTION ASSESSMENT PROGRAM

Upon clicking the 'Pollution Assessment' button in the Advanced Process Analysis Desk, the first window presented to the user is the 'Process' window shown in Figure 75.

The table 'Stream List' shows the list of all input and output streams in the process. This list is automatically retrieved based on the flowsheet diagram drawn by the user. The total molar flowrates of the streams are also retrieved and are shown in the second column of the table. The third column gives the type of the stream. As discussed in Section I, the streams important for pollution Assessment calculations are the input and output streams, and the output streams are further divided into product and non-product streams. In the table shown in Figure 75, the classification of streams into input and output is automatically done. The further classification of output streams into product and non-product needs to be done by the user. By default, all output streams are assumed to be products.

Calculation of pollution indices requires the composition of the process streams. The composition can be specified either in terms of molar flowrates or mole fractions. These values can be conveniently retrieved from the results of on-line optimization. Let us retrieve the values for the first stream in the list, C320. Click on the stream, C320 in the table 'Stream List' in Figure 75. Choose the radio button with the option 'Flowrates of components' to specify the composition. Now, let us retrieve the flowrates of the individual components in stream C320 as described below.

In Figure 75, the table 'Variables' on the right-hand side at the top shows the names and descriptions of all the measured and unmeasured variables in the Alkylation process model. Select the radio button for the option 'data only for the current stream'. When this option is selected, the table 'Variables' only shows the variables that are associated with that stream. The screen view now is shown in Figure 76. The variables associated with stream C320 can be seen in the table 'Variables' in Figure 76. Stream C320 is the depropanizer bottoms, and it contains components 1 (propane and lower hydrocarbons), 3 (isobutane), 4 (n-butane), 5 (i-pentane), 7 (i-hexane). In the 'Variables' table, x1C320, x3C320, x4C320, x5C320 and x7C320 are the mass fractions of these 5 components. Let us enter these values in the 'Components Data' table as described below.

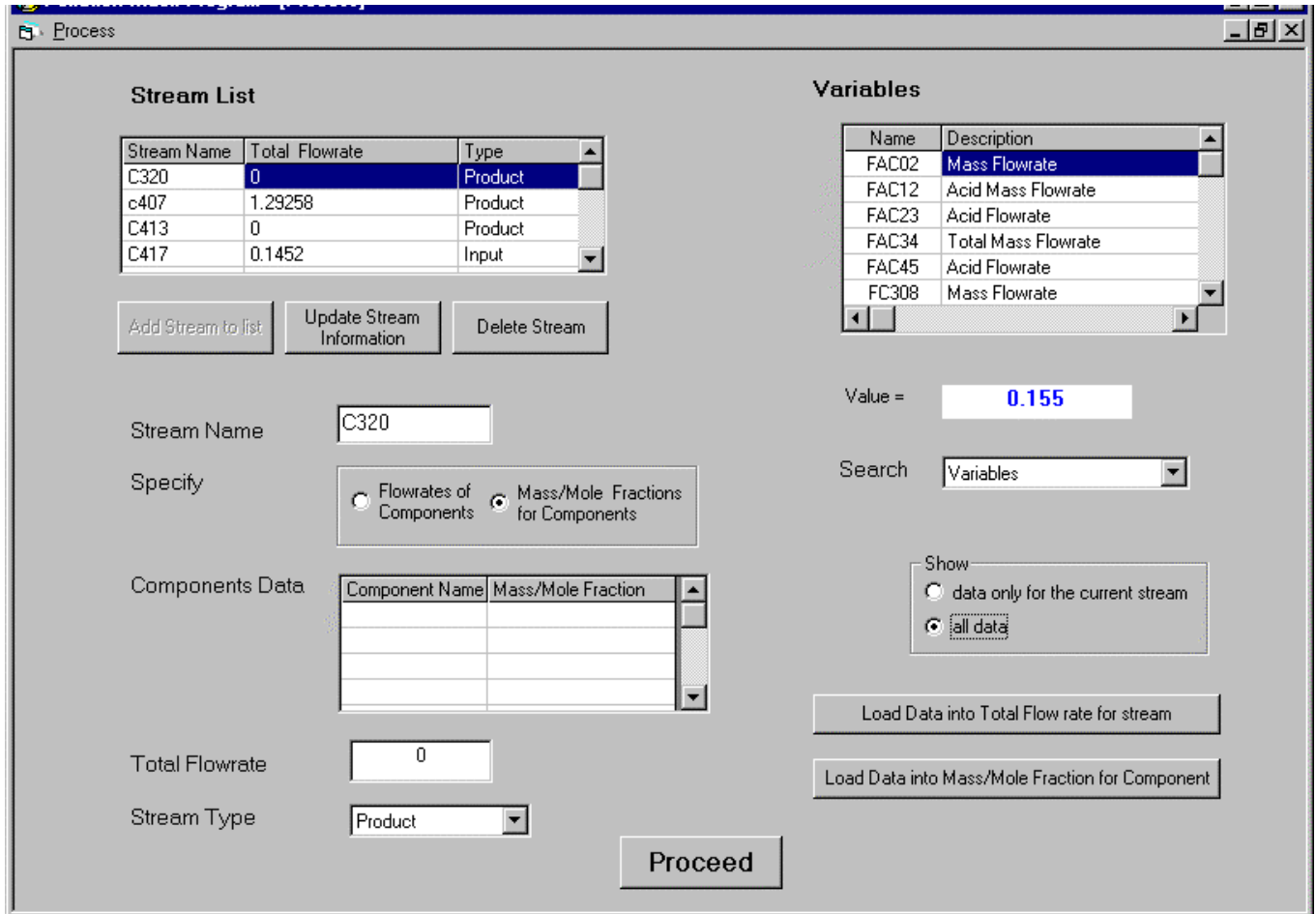


Figure 75. The Process Window of the Pollution Assessment Program

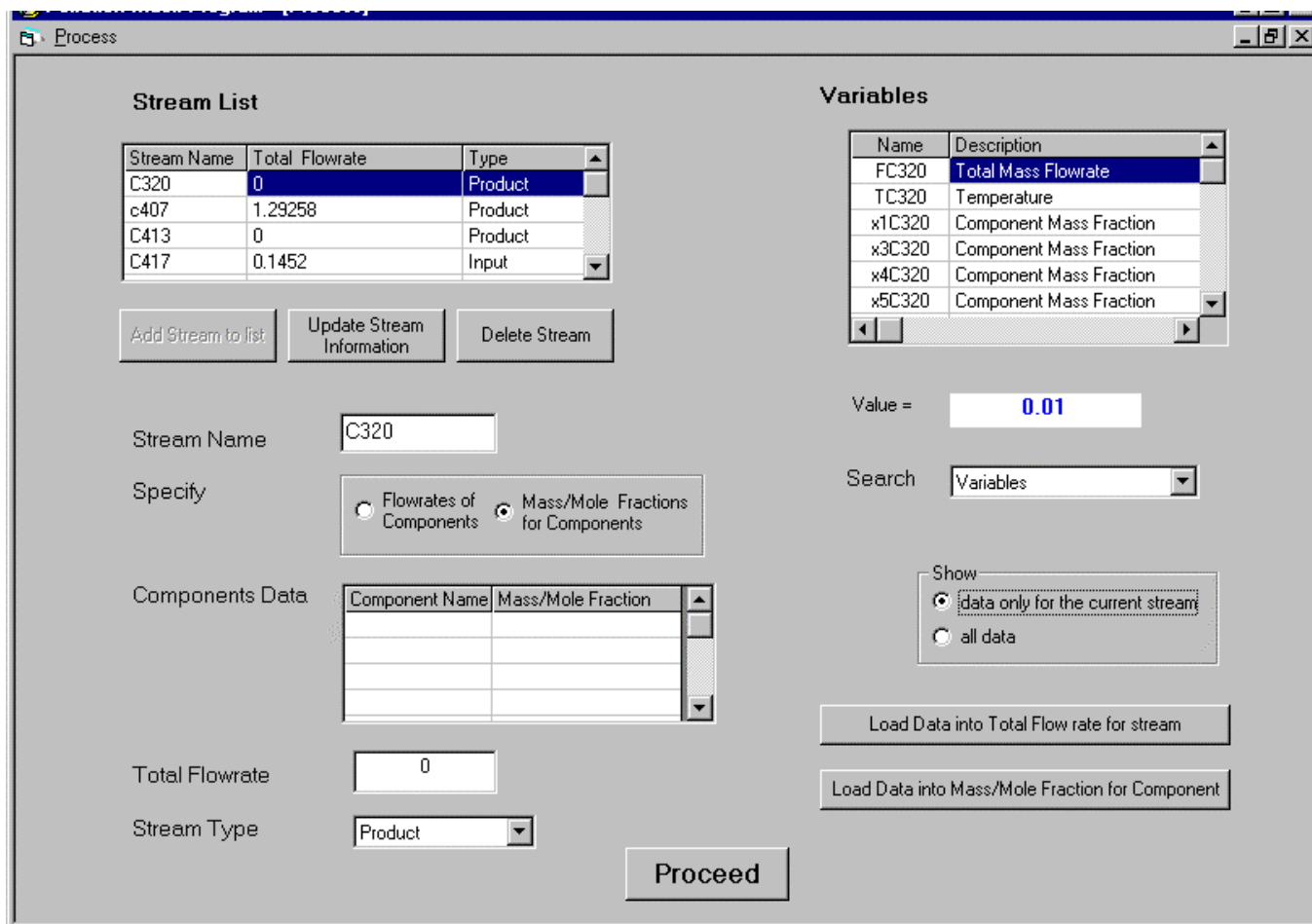


Figure 76. The Process Screen with Stream C320

In the 'Component Data' table, enter 1 in the first row of the component name column. Now click on the variable x1C320 in the 'Variables' table. The value field below the 'Variables' table now shows the value of x1C320 obtained as a result of economic optimization. To take this value as the mass fraction of component 1, click the button 'Load Data into Mass/Mole Fraction for Component'. The next component in stream C320 is component 3. Enter '3' in the second row of the 'Components Data' table. Click on the variable 'x3C320' in the 'Variables' table and then click the button 'Load Data into Mass/Mole Fraction for Component'. For components 4, 5 and 7 of the stream C320 repeat the same procedure and the composition of stream C320 is now completely specified. The stream type of stream C320 is 'product' as correctly determined by the program. The screen view now is shown in Figure 77. The above changes made to the composition data for stream C320 need to be updated. Click on the 'Update Stream Information' button to save the changes.

Repeat the same procedure for all the other streams in the table 'Stream List'. Click on each stream in the table. Enter the component names and retrieve their flowrates from the 'Variables' table. If you do not see the required variable in the table, choose the 'all data' option. For the output streams, change the default type from 'product' to 'non-product' wherever necessary. In the Alkylation process, the stream AC45 is the non-product stream. For each stream, after the changes are done, click the 'Update Stream Information' button.

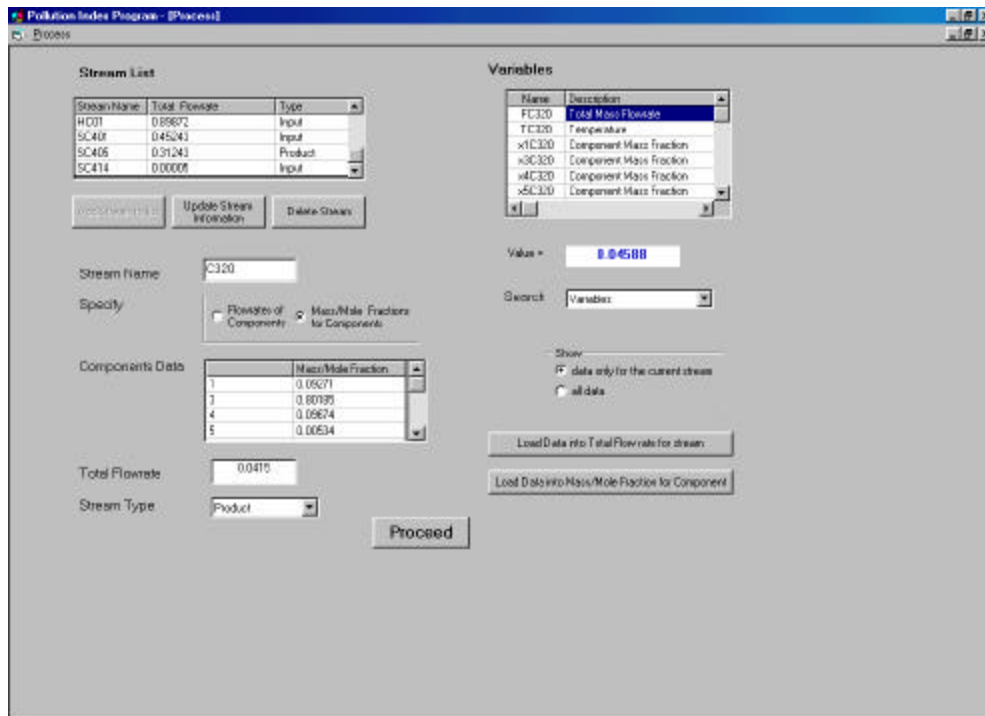


Figure 77. The Composition Data for Stream C320.

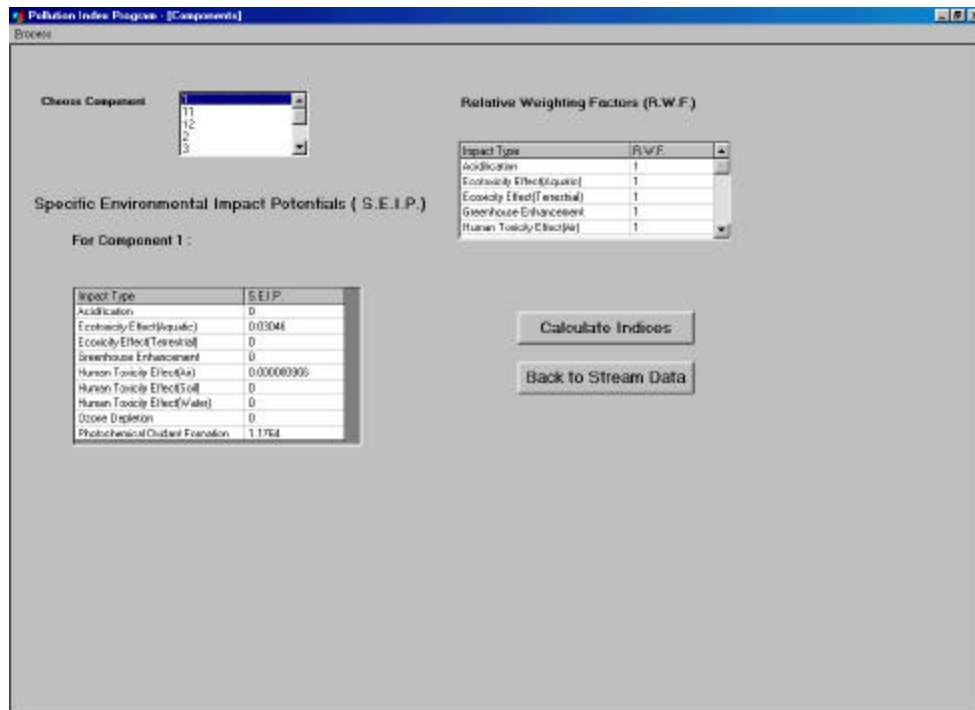


Figure 78. The Components Window

When the composition information for all the streams in table 'Stream List' has been entered, click the 'Proceed' button. The 'Components' window is now displayed on the screen. This is shown in Figure 78. This window is used to enter the specific environmental impact potentials of the various components in the process. As discussed in Section I, there are nine categories of environmental impacts. The specific environmental impact potential values have to be entered for each component for each of the nine types of impact.

The final piece of information needed is the relative weighting factors. For the Alkylation process, let us keep the default values of one for all the weighting factors. All of the information necessary for the calculation of pollution indices has been entered in the program. Now, click on the 'Calculate Indices' button to view the values of the six pollution indices defined earlier in Section I.

The program uses the data entered by the user to evaluate these indices and then displays the 'Index Calculations' window shown in Figure 79. The indices on the left-hand side are the indices based on the generation of potential environmental impacts, and the indices on the right-hand side are the indices based on the emission of impacts. These indices are calculated based on the equations in the page A-1150. Each index is accompanied by a Help button. Clicking on the 'Help' displays more information about that particular index at the bottom of the screen. The program also calculates the pollution index values for each of the individual streams. To see these values, click on the 'Show WAR algorithm' button. The program now displays the 'Waste Reduction Algorithm' window shown in Figure 80.

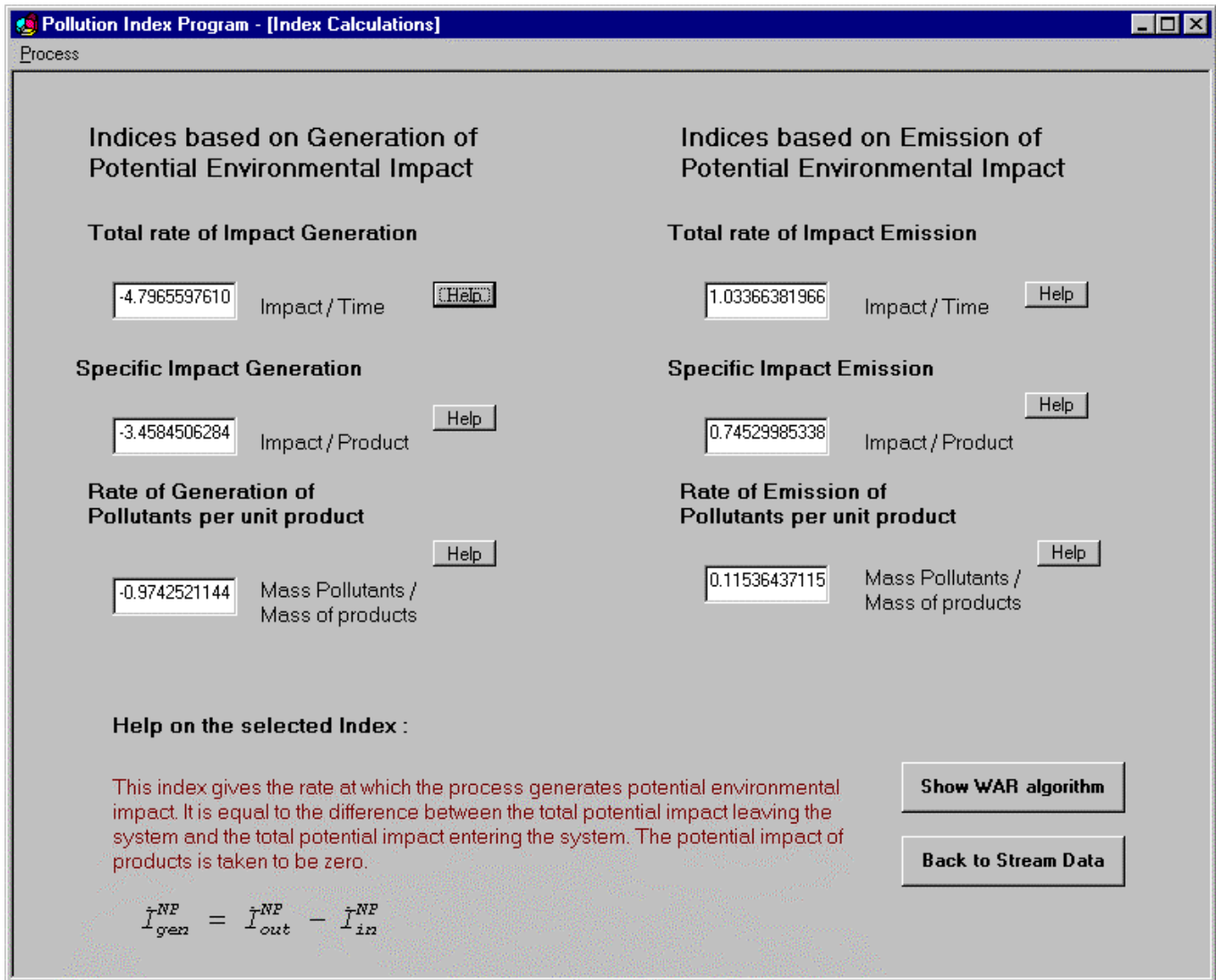


Figure 79. The Index Calculations Window

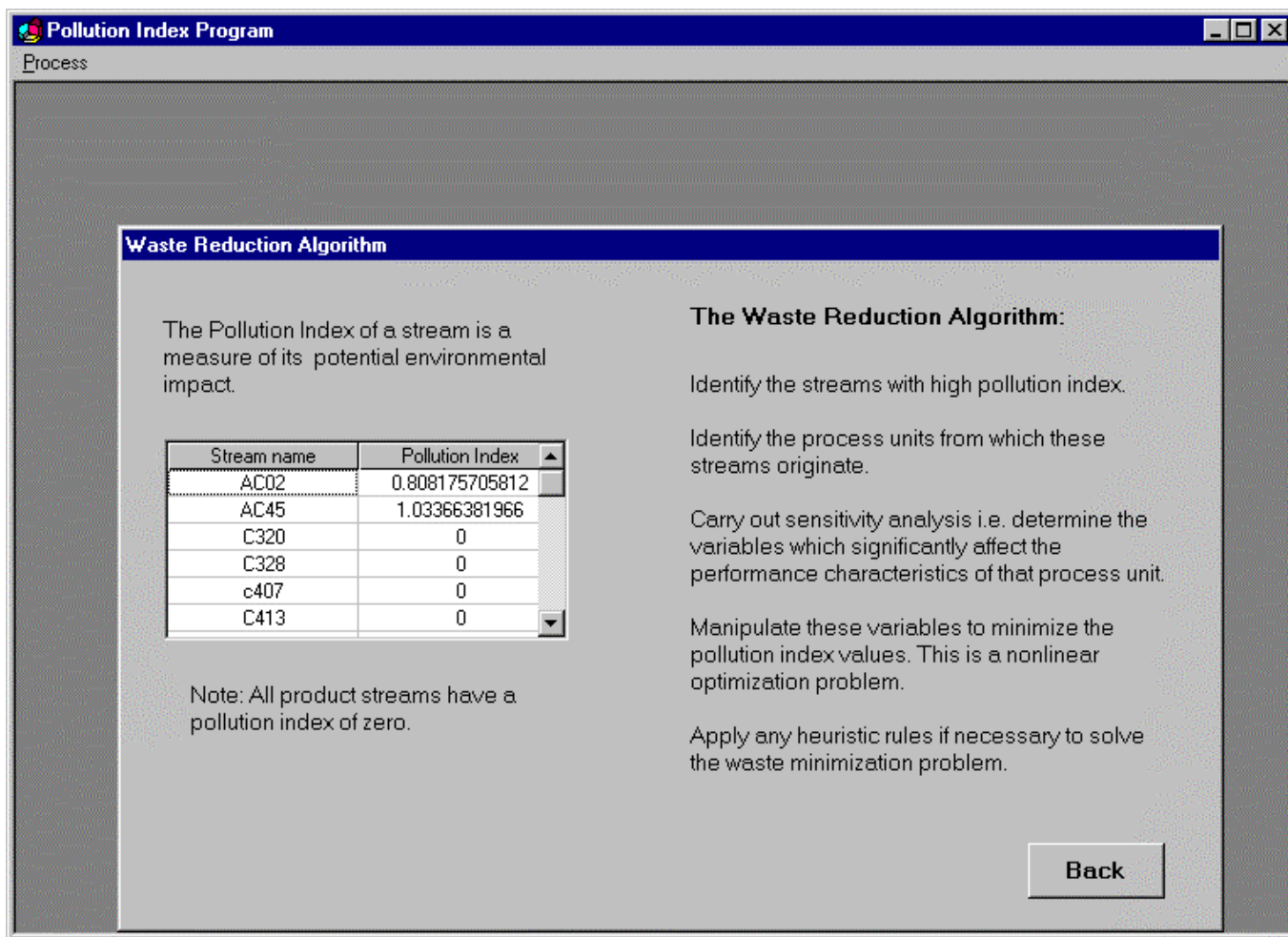


Figure 80. The Waste Reduction Algorithm Window

In Figure 80 the table on the left-hand side shows the pollution index values for all the input and output streams in the contact process. A comparison of these values can help in identifying streams with high pollution content. In Figure 80 it can be seen that the pollution index values are zero for all the streams except streams AC02, AC45, HC01, SC401 and SC414. This shows that these streams are the main source of pollutant emission into the environment and need special attention.

The right side of the 'Waste Reduction Algorithm' window shows the important steps of WAR algorithm, which gives a systematic way of approaching the waste minimization problem. The back button can be used to go back to the previous screens and make changes in the data. Click on the back button till you reach the process screen shown in Figure 75 Let us save the information entered so far by clicking on the 'save' button in the 'process' menu. The program displays the 'Save the model as' dialog box shown in Figure 81. The pollution Assessment program stores the model as a file with '.pnd' extension. Let us save this model as 'Alkylation.pnd' in the Examples subdirectory of the program folder.



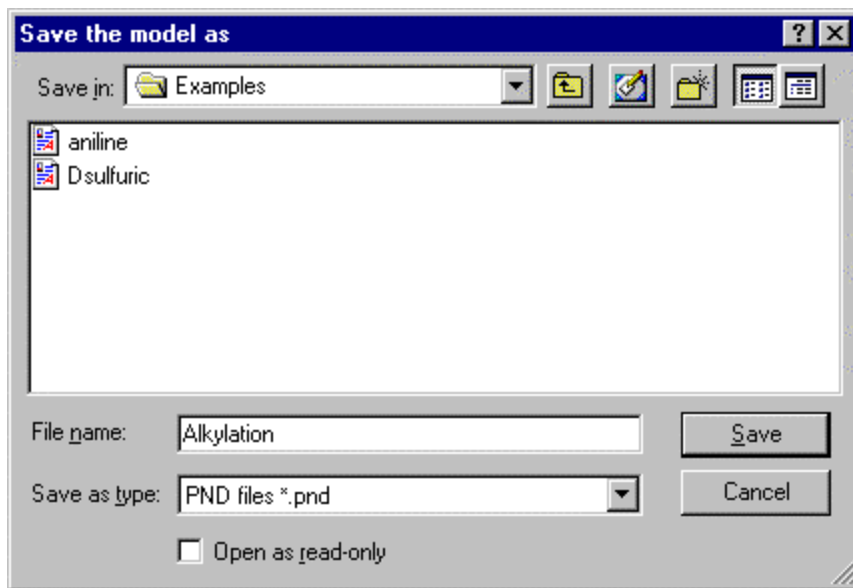


Figure 81. The Save As Window

This concludes the implementation of the Pollution Index program in the Advanced Process Analysis System. Click the 'Exit' button in the process menu to return to the Advanced Process Analysis Desk. The next section explains the use of the Chemical Reactor Analysis program.

## IX. USING CHEMICAL REACTOR ANALYSIS PROGRAM

The Reactor Analysis program can be used to predict the performance of reactors in the Alkylation process. The chemical reactor program is an integral part of the Advanced Process Analysis System, and the reactor feed flowrates and compositions are provided to the program from the database. This Chemical Reactor Analysis for Alkylation process is not shown in this manual. This will demonstrate how the reactor analysis program is integrated in the Advanced Process Analysis System.

## X. OPTIMIZATION SOLVER-GAMS

### A. Compilation Output (Brooke, et al., 1996)

The compilation output is produced during the initial check of the program, and it is often referred to as a compilation. It includes two or three parts: the echo print of the program, an explanation of any errors detected, and the symbol reference maps. The echo print of the program is always the first part of the output file. If errors had been detected, the explanatory messages would be found at the end of the echo print. The echo print of the GAMS program for the economic optimization of the contact process is included in the GAMS output file in Appendix B.

The symbol reference maps follow the echo print, and they include the symbol cross-reference and the symbol-listing map. These are extremely useful if one is looking into a model written by someone else, or if one is trying to make some changes in their own model after spending time away from it. The symbol cross reference lists the identifiers (symbols) in the model in alphabetical order, identifies their type, shows the line numbers where the symbols appear, and classifies each appearance. The complete list of data types is given in Table X.1. Next in the listing is a list of references to the symbols, grouped by reference type and identified by the line number in the output file. The actual references can then be found by referring to the echo print of the program, which has line numbers on it. The complete list of reference types is given in Table X.2. The symbol reference maps do not appear in the output files by default. However, it can be included in the output files by changing the default setting in Output File Format Specification window.

Table X.1 A List of Data Types

Entry in symbol reference table	GAMS data type
SET	set
PARAM	parameter
VAR	variable
EQU	equation
MODEL	model

### B. Execution Output

The execution output follows the compilation output and is also found in the GAMS output file. If a display statement is present in the GAMS program, then data requested by the display statement is produced in the execution output while GAMS performs data manipulations. Also, if errors are detected because of illegal data operations, a brief message indicating the cause and the line number of the offending statement, will appear in the execution output. The execution output will be shown in the GAMS output file if a display statement is present in the GAMS program (which requests the display of the value of a variable) or if an execution error is encountered.

Table X.2 A List of Reference Types

Reference	Description
DECLARED	This is where the identifier is declared as to type. This must be the first appearance of the identifier.
DEFINED	This is the line number where an initialization (a table or a data list between slashes) or symbol definition (equation) starts for the symbol.
ASSIGNED	This is when values are replaced because the identifier appears on the left of an assignment statement.
IMPL-ASN	This is an “implicit assignment”: an equation or variable will be updated as a result of being referred to implicitly in a solve statement.
CONTROL	This refers to the use of a set as the driving index in an assignment, equation, loop or other indexed operation (sum, prod, smin or smax).
REF	This is a reference: the symbol has been referenced on the right of an assignment in a display, in an equation, or in a model or solve statement.

### C. Output produced by a Solve Statement (Brooke, et al., 1996)

The output triggered by a solve statement includes the equation listing, the column listing, the model statistics, solver report, the solution listing, report summary, and file summary as shown in the GAMS output file in Section X. All of the output produced as a result of a SOLVE statement is labeled with a subtitle identifying the model, its type, and the line number of the solve statement.

The first list in the output produced by the SOLVE statement is the Equation Listing, which is marked with that subtitle in the output file. The Equation Listing is an extremely useful debugging aid. It shows the variables that appear in each constraint, and what the individual coefficients and right-hand-side value evaluate to after the data manipulations have been made. Normally, the first three equations in every block are listed. Most of the listing is self-explanatory. The name, text, and type of constraints are shown. The four dashes are useful for mechanical searching. All terms that depend on variables are collected on the left, and all the constant terms are combined into one number on the right, with any necessary sign changes made. For example, a equation “ $x + 5y - 10z + 20 = 0$ ” is rearranged as: “ $x + 5y - 10z = -20$ ”. Four places of decimals are shown if necessary, but trailing zeroes following the decimal point are suppressed. E-format is used to prevent small numbers being displayed as zero. By default, the equation listing will not appear in the output file unless specified by the user in the Output File Format Specification Window.

The general format in the equation listing was described above. However, the nonlinear terms in an equation are treated differently from the linear terms. If the coefficient of a variable in the Equation Listing is enclosed in parentheses, then the variable corresponding to this coefficient is nonlinear in the constraint equation, and the value of the coefficient depends on the activity levels of one or more of the variables. This coefficient is not algebraic, but it is the partial derivative of each variable evaluated at their current level values (initial points).

For an equation:  $x + 2y^3 + 10 = 0$  with current level values  $x = 2$  and  $y = 1$ , this equation is listed in the equation listing as:  $x + (6) y = -12$ , where the coefficient of  $y$  is the partial derivative of the equation with respect to  $y$  evaluated at  $y=1$ , i.e.,  $6y^2 = 6$ . The right hand side coefficient,  $-12$ , is the sum of constant in the equation,  $10$ , and the constant,  $2$ , from the linearization of the nonlinear term  $2y^3$  using Taylor expansion evaluated at  $y = 1$ .  $x$  in this equation is linear, and its coefficient is shown as  $1$  without the parentheses.

Next, the column listing gives the individual coefficients sorted by column rather than by row. The default shows the first three entries for each variable, along with their bound and level values. The format for the coefficients is the same as in the equation listing, with the nonlinear ones enclosed in parentheses and the trailing zeroes dropped. The order in which the variables appear is the order in which they were declared.

The final information generated while a model is being prepared for solution is the statistics block to provide details on the size and nonlinearity of the model. The status for the solver (the state of the program) and the model (what the solution looks like) are characterized in solver status and model status. The model status and solver status are listed in Table X.3 and Table X.4, respectively.

The next section is the solver report, which is the solve summary particular to the solver program that has been used. Also, there will be diagnostic messages in plain language if anything unusual was detected, and specific performance details as well. In case of serious trouble, the GAMS listing file will contain additional messages printed by the solver, which may help, identify the cause of the difficulty.

Solution listing is a row-by-row then column-by-column listing of the solutions returned to GAMS by the solver program. Each individual equation and variable is listed with four pieces of information. The four columns associated with each entry are listed in Table X.5. For variables, the values in the LOWER and UPPER columns refer to the lower and upper bounds. For equations, they are obtained from the (constant) right-hand-side value and from the relational type of the equation. EPS means very small or close to zero. It is used with non-basic variables whose marginal values are very close to, or actually, zero, or in nonlinear problems with super-basic variables whose marginal values are zero or very close to it. A superbasic variable is the one between its bounds at the final point but not in the basis.

For models that do not reach an optimal solution, some constraints may be marked with the flags shown in Table X.6. The final part of solution listing is the report summary marked with four asterisks. It shows the count of rows or columns that have been marked INFES, NOPT, UNBND. The sum of infeasibilities will be shown if the reported solution is infeasible. The error count is only shown if the problem is nonlinear. The last piece of the output file is the file summary, which gives the names of the input and output disk files. If work files have been used, they will be named here as well.

## D. Error Reporting

The last part in the output file is error reporting. All the comments and descriptions about errors have been collected into this section for easy reference. Errors are grouped into the three phases of GAMS modeling in the on-line optimization system: compilation, execution and model generation (which includes the solution that follows). They will be illustrated in the section, “Error Reporting”.

Table X.3 A List of Model Status in GAMS Output Files

Model status	Meaning
1. Optimal	This means that the solution is optimal. It only applies to linear problems or relaxed mixed integer problems (RMIP).
2. Locally Optimal	This message means that a local optimal for nonlinear problems, since all that can guarantee for general nonlinear problems is a local optimum.
3. Unbounded	That means that the solution is unbounded. It is reliable if the problem is linear, but occasionally it appears for difficult nonlinear problem that lack some strategically paced bounds to limit the variables to sensible values.
4. Infeasible	This means that the linear problem is infeasible.
5. Locally Infeasible	This message means that no feasible point could be found for the nonlinear problem from the given starting point. It does not necessarily mean that no feasible point exists.
6. Intermediate Infeasible	The current solution is not feasible, the solver program stopped, either because of a limit (iteration or resource), or some sort of difficulty.
7. Intermediate Nonoptimal	This is again an incomplete solution, but it appears to be feasible.
8. Integer Solution	An integer solution has been found to a MIP (mixed integer problem).
9. Intermediate Noninteger	This is an incomplete solution to a MIP. An integer solution has not yet been found.
10. Integer	There is no integer solution to a MIP. This message should be reliable.
11. Error Unknown, Error no Solution	There is no solution in either of these cases.

Table X.4 A List of Solver Status in GAMS Output Files

Solver status	Meaning
1. Normal Completion	This means that the solver terminated in a normal way: i.e., it was not interrupted by an iteration or resource limit or by internal difficulties. The model status describes the characteristics of the accompanying solution.
2. Iteration Interrupt	This means that the solver was interrupted because it used too many iterations. Use option iterlim to increase the iteration limit if everything seems normal.
3. Resource Interrupt	This means that the solver was interrupted because it used too much time. Use option reslim to increase the time limit if everything seems normal.
4. Terminated by Solver	This means that the solver encountered difficulty and was unable to continue. More detail will appear following the message.
5. Evaluation Error Limit	Too many evaluations of nonlinear terms at undefined values. You should use bounds to prevent forbidden operations, such as division by zero. The rows in which the errors occur are listed just before the solution.
6. Unknown Error Preprocessor(s) Error Setup Failure Error Solver Failure Error Internal Solver Error Error Post-Processor	All these messages announce some sort of unanticipated failure of GAMS, a solver, or between the two. Check the output thoroughly for hints as to what might have gone wrong.

Table X.5 A List of Solution Listing Types

Heading in listing file	Description
LOWER	Lower Bound (.lo)
LEVEL	Level Value (.l)
UPPER	Upper Bound (.up)
MARGINAL	Marginal (.m)

Table X.6 A List of Constraint Flags

Flag	Description
INFES	The row or column is infeasible. This mark is made for any entry whose LEVEL value is not between the UPPER and LOWER bounds.
NOPT	The row or column is non-optimal. This mark is made for any non-basic entries for which the marginal sign is incorrect, or superbasic ones for which the marginal value is too large.
UNBND	The row or column that appears to cause the problem to be unbounded.

### E. GAMS Input Model (Brooke et al., 1996)

The basic components of a GAMS input model include:

- Sets
- Data (Parameters, Tables, Scalar)
- Variables
- Assignment of bounds and/or initial values
- Equations
- Model and Solve statements
- Display/Put statement

The overall content of GAMS output file is:

- Echo Print
- Reference Maps
- Equation Listings
- Status Reports
- Results

#### E-1. Format for Entering System Information

The GAMS input code generated by the interactive on-line optimization system is based on the information provided by the user. Although the user usually does not need to consider the format of the GAMS program, there are some regulations about the format related to GAMS that must be followed to properly enter information about the plant. The input must be in correct format for an accurate GAMS input file to be generated automatically by the on-line optimization system.

Most of the characters and words are allowable for the input information, however, the letters in the input information are case insensitive. A few characters are not allowed for the input because they are illegal or ambiguous on some machines. Generally, all unprintable and control characters are illegal. Most of the uncommon punctuation characters are not part of the language, but can be used freely. In Table X.7, a full list of legal characters is given.

Besides characters, there are some reserved words and non-alphanumeric symbols with predefined meanings in GAMS, which can not be used, in input information. The reserved words and non-alphanumeric symbols are listed in Table X.8 and Table X.9, respectively.

Table X.7 A List of Full Set of Legal Characters for GAMS

A to Z	alphabet	a to z	alphabet	0 to 9	Numerals
&	ampersand	“ ”	double quote	#	pound sign
*	asterisk	=	equals	?	question mark
@	at	>	greater than	;	semicolon
\	back slash	<	less than	‘	single quote
:	Colon	-	minus	/	slash
,	comma	( )	parenthesis		space
\$	Dollar	[ ]	square brackets	_	underscore
.	Dot	{ }	braces	!	exclamation mark
+	Plus	%	percent	^	circumflex

Table X.8 A List of All Reserved Words for GAMS

abort	ge	Not	smin	if
acronym	gt	Option	sos1	then
acronyms	inf	Options	sos2	else
alias	integer	Or	sum	semicont
all	le	Ord	system	semiint
and	loop	Parameter	table	file
assign	lt	Parameters	using	files
binary	maximizing	Positive	variable	putpage
card	minimizing	Prod	variables	puttl
display	model	Scalar	xor	free
eps	models	Scalars	yes	no
eq	na	Set	repeat	solve
equation	ne	Sets	until	for
equations	Negative	Smax	while	



In the on-line optimization system, numeric values are entered in a style similar to that used in other computer languages. Blanks cannot be used in a number because the system treats a blank as a separator. The common distinction between real and integer data types does not exist. If a number is entered without a decimal point, it is still stored as a real number. In addition, the system uses an extended range arithmetic that contains special symbols for infinity (INF), negative infinity (-INF), undefined (UNDF), epsilon (EPS), and not available (NA) as shown in Table X.10. One cannot enter UNDF; it is only produced by an operation that does not have a proper result, such as division by zero. All other special symbols can be entered and used as if they were ordinary numbers.

Table X.9 A List of Non-alphanumeric Symbols for GAMS

=l=	--
=g=	++
=e=	**
=n=	

GAMS uses a small range of numbers to ensure that the system will behave in the same way on a wide variety of machines. A general rule is to avoid using or creating numbers with absolute values greater than 1.0e+20. A number up to 10 significant digits can be entered on all machines, and some machines can even support more than that. However, if a number is too large, it may be treated by the system as undefined (UNDF), and all values derived from it in a model may be unusable. It is recommended to always use INF (or -INF) explicitly for arbitrarily large numbers. When an attempted arithmetic operation is illegal or has undefined results because of the value of arguments (division by zero is the normal example), an error is reported and the result is set to undefined (UNDF). Afterwards, UNDF is treated as a proper data value and does not trigger any additional error messages. Thus, the system will not solve a model if an error has been detected, but it will terminate with an error condition.

The string definition such as the variable's name in the system has to start with a letter followed by more letters or digits. It can only contain alphanumeric characters and up to 10 characters long. The comment to describe the set or element must not exceed 80 characters. Basically, there are five possible types of variables that may be used which are listed in Table X.11.

The type of mathematical programming problem must be known before the problem is solved. The on-line optimization system can only solve linear and nonlinear optimization problems. However, GAMS can solve a large number of optimization problems, which are summarized in Table X.12.

As the interactive on-line optimization system writes all the required GAMS input files for the user, most of the components in the GAMS input model are automatically formulated from the information provided in the input windows. If the user can follow the explicit rules introduced above, the GAMS input file can be generated automatically. After the user enters all the plant information through the input windows, the GAMS source codes will be generated.

Table X.10 A List of Special Symbols for GAMS

Special symbol	Description
INF	Plus infinity. A very large positive number
-INF	Minus infinity. A very large negative number
NA	Not available. Used for missing data. Any operation that uses the value NA will produce the result NA
UNDF	Undefined. The result of an undefined or illegal operation. The user cannot directly set a value to UNDF
EPS	Very close to zero, but different from zero.

Table X.11 A List of Types of Variables for GAMS

Keyword	Default Lower Bound	Default Upper Bound	Description
Free (default)	-inf	+inf	No bounds on variables. Both bounds can be changed from the default values by the user
Positive	0	+inf	No negative values are allowed for variables. The upper bound can be changed from the default value by the user
Negative	-inf	0	No positive values are allowed for variables. The user can change the lower bound from the default value.
Binary	0	1	Discrete variable that can only take values of 0 or 1
Integer	0	100	D Discrete variable that can only take integer values between the bounds. Bounds can be changed from the default value by the user

The on-line optimization system will then forward these source codes to the GAMS software. This initiates the execution of GAMS and also creates output files so the user can view the execution in the output window. The execution and the output has been discussed in the previous sections.

Table X.13 A List of Types of Models for GAMS

Model Type	Description
LP	Linear programming. No nonlinear terms or discrete (binary or integer) variables.
NLP	Nonlinear programming. There are general nonlinear terms involving only “smooth” functions in the model, but no discrete variables.
DNLP	Nonlinear programming with discontinuous derivatives. Same as NLP, but “non-smooth” functions can appear as well. More difficult to solve than NLP. Not recommended to use.
RMIP	Relaxed mixed integer programming. Can contain discrete variables but the integer and binary variables can be any values between their bounds.
MIP	Mixed integer programming. Like RMIP but the discrete requirements are enforced: the discrete variables must assume integer values between their bounds.
RMINLP	Relaxed mixed integer nonlinear programming. Can contain both discrete variables and general nonlinear terms. The discrete requirements are relaxed. Same difficulty as NLP.
MINLP	Mixed integer nonlinear programming. Characteristics are the same as for RMINLP, but the discrete requirements are enforced.
MCP	Mixed Complementarily Problem
CNS	Constrained Nonlinear System

## E-2. Equation Formulation

Besides the rules introduced above, the equations as the main part of the input information have their own specific requirements. The mathematical definitions of equations can be written in one or multiple lines. Blanks can be inserted to improve readability, and expressions can be arbitrarily complicated. The standard arithmetic operations for the equations are listed in Table X.14. The arithmetic operations listed in Table X.14 are in order of precedence, which determines the order of evaluation in an equation without parentheses. The relational operators in the equations are:

- =L= Less than: left hand side (lhs) must be less than or equal to right hand side (rhs)
- =G= Greater than: lhs must be greater than or equal to rhs
- =E= Equality: lhs must equal to rhs
- =N= No relationships enforced between lhs and rhs. This type is rarely used.

Additionally, GAMS provides the numerical relationships and logical operators used to generate logical conditions for evaluating values of True or False. A result of zero is treated as a logical value of False, while a non-zero result is treated as a logical value of True. A complete numerical relationship operators and logical operators are listed in the Table X.15 and Table X.16, respectively.

Table X.14 A List of Standard Arithmetic Operators

Operator	Description
**	Exponentiation
*, /	Multiplication and division
+, -	Addition and subtraction (unary and binary)

Table X.15 A List of Numerical Relationship Operators

Operator	Description
lt, <	Strictly less than
le, <=	Less than or equal to
eq, =	Equal to
ne, <>	Not equal to
ge, >=	Greater than or equal to
gt, >	Strictly greater than

Table X.17 A List of Logical Operators

Operator	Description
not	Not
And	And
Or	Inclusive or
Xor	Exclusive or

Table X.18 The Truth Table Generated by the Logical Operators

Operands		Results			
A	b	a and b	a or b	a xor b	not a
0	0	0	0	0	1
0	non-zero	0	1	1	1
Non-zero	0	0	1	1	0
Non-zero	non-zero	1	1	0	0

Table X.19 The Operator Precedence Order in case of Mixed Logical Conditions

Operation	Operator
Exponentiation	**
Numerical Operators	
Multiplication, Division	*, /
Unary operators - Plus, Minus	+, -
Binary operators - Addition, Subtraction	+, -
Numerical Relationship Operators	<, <=, =, <>, >=, >
Logical Operators	
Not	not
And	and
Or, xor	or, xor

The functions of the logical operators are expressed in Table X.18. For the mixed logical conditions, the default operator precedence order used by GAMS in the absence of parenthesis is shown in Table X.19 in decreasing order. For the formulation of equations, variables can appear on the left or right-hand side of an equation or on both sides. The system can automatically convert the equation to its standard form (variables on the left, no duplicate appearances) before calling the GAMS solver. For the convenience of input, the system also provides several special notations, such as summation (sum) and product (prod), minimum value (smin), maximum value (smax).

### E-3. Functions Predefined in the System

There are two types of functions based on the type of argument: exogenous or endogenous. For exogenous arguments, the arguments are known, and examples are parameters and variable attributes. The expression is evaluated once when the model is set up. All functions except the random distribution functions, uniform and normal, are allowed. With endogenous arguments, the arguments are variables, and are, therefore, unknown. The function will be evaluated many times at intermediate points while the model is being solved. The occurrence of any function with endogenous arguments implies that the model is not linear and the use of the functions of “uniform” and “normal” are forbidden in an equation definition. Some built-in functions are listed in Table X.20.

### E-4. Scaling Option for Variables and Equations

To facilitate the translation between a natural model (no scaling) to a well scaled model, GAMS introduces the concept of a scale factor for variables and equations with a scaling option. This feature is incorporated in the interactive on-line optimization system to provide a well-scaled optimization problem

for GAMS to solve. To use the scaling option in the interactive on-line optimization, the user must highlight the scaling option in the variable declaration and the equations declaration windows. Then, the user must enter the values of the scale factors for the variables and equations that need to be scaled. The following describes how the scale factor is incorporated in the GAMS program and how to determine the value of a scale factor.

The scale factor on a variable  $V^s$  is used to relate the variable as seen by user (in natural model)  $V^u$  to the variable as seen by the optimization algorithm (in well scaled model)  $V^a$  as follows:

$$V^u = V^a V^s$$

This means that the scaled variable  $V^a$  will become around 1 if the scale factor  $V^s$  is chosen to represent the order of magnitude of the user variable  $V^u$ .

If the approximate expected value for a variable in the model is known, then the magnitude of this variable value is used as the scale factor of the variable. The scale factor can be specified by users through the Measured or Unmeasured Variables window. If the approximate expected values for some of the variables in the model are not available, these values can be found in the column list of the corresponding GAMS output file. The scale factor will not change the values of variables in the solution seen by users. GAMS uses the scale factor to scale variables and transfer the model into a well scaled model for optimization algorithm. When the optimal solution is found, GAMS will rescale the variables and transfer them back to user's notation. The effect of scaling can only be viewed in the Column and Equation lists of the GAMS output files.

The scale factor for an equation is dependent on the order of magnitude of the equation coefficients. It is slightly different from the determination of scale factor for a variable that is dependent on the magnitude of the variable. An equation usually contains several terms, and it has several coefficients that may not be in the same order.

If the equation is linear, the coefficients of this equation is known. If the equation is nonlinear, then the equation is linearized first using the initial values. However, the linearized coefficients must be obtained from the equation list. Users can obtain the values of the linearized equation coefficients for nonlinear constraints from the equation list of the corresponding GAMS output file. To appropriately assign the scale factor for an equation, users need to carefully select the value of the scale factor based on the coefficients shown in equation list of the GAMS output file so that all coefficients will be in the range of 0.01 to 100 after scaling.

The column (variables) and equation lists are very important for nonlinear problems when scaling the variables and equations. It provides initial values of all variables and linearized constraint coefficients, which can be used to determine the scale factors for both variables and equations. It is suggested that the user turn off the scaling option for both variables and equations before GAMS is initiated.

Table X.20 A List of Functions Predefined in the On-line Optimization System

Function	Description	Classification	Exogenous Classification	Endogenous model type
Abs	Absolute value	Non-smooth	Legal	DNLP
Arctan	Arctangent	Smooth	Legal	NLP
Ceil	Ceiling	Smooth	Legal	Illegal
Cos	Cosine	Discontinuous	Legal	NLP
Errorf	Error function	Smooth	Legal	NLP
Exp	Exponential	Smooth	Legal	NLP
Floor	Floor	Discontinuous	Legal	Illegal
Log	Natural log	Smooth	Legal	NLP
Log10	Common log	Smooth	Legal	NLP
Mapval	Mapping function	Discontinuous	Legal	Illegal
Max	Largest value	Non-smooth	Legal	DNLP
Min	Smallest value	Non-smooth	Legal	DNLP
Mod	Remainder	Discontinuous	Legal	Illegal
Normal	Normal random	Illegal	Illegal	Illegal
Power	Integer power	Smooth	Legal	NLP
Round	Rounding	Discontinuous	Legal	Illegal
Sign	Sign	Discontinuous	Legal	Illegal
Sin	Sine	Smooth	Legal	NLP
Sqr	Square	Smooth	Legal	NLP
Sqrt	Square root	Smooth	Legal	NLP
Trunc	Truncation	Discontinuous	Legal	Illegal
Uniform	Uniform random	Illegal	Illegal	Illegal

After the program ends, if the solution is correct and there was no difficulty in searching for an optimal solution, then the scaling option is not necessary. If the solution is not correct or some difficulty was encountered while searching for an optimal solution, then the scaling option must be incorporated in the program. In this case, users may instruct the system to include the column and equation lists in the output file. To do this, the user must change the default setting for the output files in window 12, the

Output File Format Specification window. This will run the optimization program without the scaling option. Based on the values of variables in column list without scaling, users can decide the values of scale factors for variables, enter them in the Measured Variables and Unmeasured variables windows, and highlight the icon “Include Scaling Option for variables” to scale the variables first. After the system executes the program, a new equation list, which incorporates the scale information of variables, is generated and can be used for equation scaling. Based on the linearized coefficients in this new equation list, users can determine the scale factors for the equations and enter them in the Equality Constraints and Inequality Constraints windows. Also, users must highlight the icon “Include Scaling Option for Equations” to add the Scaling Option in the programs.

## **E-5. Error Reporting**

During compiling, executing, and solving the optimization problem, GAMS checks the input source code for program syntax, rearranges the information in the source code, and solves the optimization problem. At every step, GAMS records any error encountered and reports it in the GAMS output file. The following describes error reporting during solving the optimization problems.

### **Compilation Errors**

The first type of error is a compilation error. When the GAMS compiler encounters an error in the input file, it inserts a coded error message inside the echo print on the line immediately following the scene of the offense. The message includes a \$-symbol and an error number printed below the offending symbol (usually to the right). This error number is printed on a separate line starting with four asterisks (\*\*\*\*). If more than one error occurs on a line, the \$-signs may be suppressed and the error number is squeezed. GAMS programs are generated by the system, and no serious compilation errors are expected to appear. The most common error will be a spelling error, i.e., the variables defined in the equations may be mistyped and mismatch while declaring the variables. This will result in “variable undefined error”. GAMS will not list more than 10 errors on any single line. At the end of the echo print, a list of all error numbers encountered, together with a description of the probable cause of each error, will be printed. The error messages are self-explanatory and will not be listed here. Checking the first error is recommended because it has the highest priority.

### **Execution Errors**

The second type of error is an execution error. Execution errors are usually caused by illegal arithmetic operations such as division by zero or taking the log of a negative number. GAMS prints a message on the output file with the line number of the offending statement and continues execution. A GAMS program should never abort with an unintelligible message from the computer’s operating system if an invalid operation is attempted. GAMS has rigorously defined an extended algebra that contains all operations including illegal ones. The model library problem [CRAZY] contains all non-standard operations and should be executed to study its exceptions. GAMS arithmetic is defined over the closed interval  $[-INF, INF]$  and contains values EPS (small but not zero), NA (not available), and UNDF (the result of an illegal operation). The results of illegal operations are propagated through the entire system and can be displayed with standard display statements. The model cannot be solved if errors have been detected previously.



## **Solve Errors**

The last type of error is a solve error. The execution of a solve statement can trigger additional errors called MATRIX errors, which report on problems encountered during transformation of the model into a format required by the solver. Problems are most often caused by illegal or inconsistent bounds, or an extended range value being used as a matrix coefficient. Some solve statements require the evaluation of nonlinear functions and the computation of derivatives. Since these calculations are not carried out by the system but by other subsystems not under its direct control, errors associated with these calculations are reported in the solution report.

If the solver returns an intermediate solution because of evaluation errors, then a solution will still be attempted. The only fatal error in the system that can be caused by a solver program is the failure to return any solution at all. If this happens as mentioned above, all possible information is listed on the GAMS output file, but the solution will not be given.

## **XII. Acknowledgments**

We gratefully acknowledge the Gulf Coast Hazardous Substance Research Center and the Environmental Protection Agency for support of this work. Also, the assistance of Ms. Gayathri Srinivasan, Mr. Tai Lee, Mr. Huitao Liu, and Ms. Qing Chen in Visual Basic programming was invaluable in developing the program.

### XIII. References

- Brooke, A., D. Kendrick, and A. Meeraus, 1996, *GAMS User's Guide*, Release 2.25, GAMS Development Corporation, Washington, D.C.
- Cabezas, H., J. C. Bare and S. K. Mallick, 1997, "Pollution Prevention with Chemical Process Simulators: The Generalized Waste Reduction Algorithm," *Computers Chem. Engng.*, Vol. 21, Supp. p. S305-S310.
- Chen, X., 1998, *The Optimal Implementation of On-line Optimization for Chemical and Refinery Processes*, Ph. D. Dissertation, Louisiana State University, Baton Rouge, LA.
- Darby, M. L., and D. C. White, 1988, "On-Line Optimization of Complex Process Units," *Chemical Engineering Progress*, Vol. 84, No. 8 p. 51-59.
- Felder, R. M. and R. W. Rousseau, 1986, *Elementary Principles of Chemical Engineering*, Second Ed., John Wiley and Sons, New Year, p. 423.
- Harris, J. L. and J. R. Norman, 1972, "Temperature-Dependent Kinetic Equation for Catalytic Oxidation of Sulfur Dioxide," *Ind. Eng. Chem. Process Des. Develop.*, Vol. 11, p. 564.
- Heijungs, R. (Final Ed.); Guinee, J. B., Huppes, G., Lankreijer, R. M., Udo de Haes, H. A. and Wegener, S. A., 1992, *Environmental Life Cycle Assessment of Products Guide - October 1992*, Center of Environmental Science, Leiden.
- Hertwig, T., 1997, Private Communication.
- Hilaly, A. K. and Sikdar, S. K., 1994, "Pollution Balance: A New Methodology for Minimizing Waste Production in Manufacturing Processes," *J. Air and Waste Manage. Assoc.*, Vol. 44, p. 1303-1308.
- Kelly, D. N., F. C. Fatora, and S. L. Davenport, 1996, "Implementation of a Closed Loop Real Time Optimization System on a Large Scale Ethylene Plant," Private Communication.
- Knopf, F. C., Pethe, Singh, Bhargava and Dhooper, 1989, *THEN User's Manual*.
- McBride, B. J., S. Gordon and M. A. Reno, 1993, *Coefficients for Calculating Thermodynamic and Transport Properties of Individual Species*, NASA Technical Memorandum 4513.
- Telang, K. S., R. W. Pike, F. C. Knopf, J. R. Hopper, J. Saleh, S. Waghchoure, S. C. Hedge and T. A. Hertwig., 1999, "An Advanced Process Analysis System for Improving Chemical and Refinery Processes," *Computers and Chemical Engineering*, Vol. 23, p. S727-730

## **APPENDIX A**

### **CONSTRAINT EQUATIONS FOR SULFURIC ACID PROCESS**

In this section, the constraint equations are listed for each of the units in the Motiva Alkylation process shown in Figure 9. The Alkylation Process Model, “Alkyl”, has 1,579 equality constraints and 50 inequality constraints to describe 76 process units and 110 streams. The material and energy balances as well as reaction rate equation for the units in the reactor system are shown in Tables A.1 through A.9.

Table A.1. Constraint equations for **Reactor (5C-623)**

Material Balances	
Overall	$F_{HC07} + F_{HC34} + F_{AC07} - F_{AC09} = 0$ $F_{R2} - F_{R3} = 0$
Species	$F_{HC07}^i + F_{HC34}^i - F_{AC09}^i + r^i V_{5C623}^a MW^i = 0$ $F_{AC07}^{i'} - F_{AC09}^{i'} - R_{5C623}^a = 0$ $R_{5C623}^a = 0.121 Q_{HC07}^{C4=}$ <p>where, <math>i= 1,2,3,4,5,6,7,8,9,10</math> and <math>i'= 11</math></p>
Energy Balances	
	$h_{HC07} + h_{HC34} + h_{AC07} + h_{R2} + H_{5C623} - h_{AC09} - h_{R3} = 0$ $h_{R2} - h_{R3} - U_{5C623} A_{5C623} \Delta T_{lm} = 0$

Table A.2. Constraint Equations of acid settler(5C-631)

Material Balances	
	$F_{AC09}^i - F_{HC27}^i = 0 \quad i=1,2,3,4,5,7$
	$F_{AC09}^{11} + F_{AC09}^{12} - F_{AC05} - F_{AC12} = 0$
	$F_{AC05}^{11} - s_{C631} F_{AC09}^{11} = 0$
	$F_{AC05}^{12} - s_{C631} F_{AC09}^{12} = 0$
	$x_{AC05}^{11} - x_{AC12}^{11} = 0$
Energy Balances	
	$T_{AC09} = T_{HC27}; T_{AC09} = T_{AC12}; T_{AC09} = T_{AC05}$

Table A.3. Constraint equations for **Depropanizer (5C-603)**

Material Balances	
Overall	$F_{C316} + F_{C329} - F_{C317} - F_{C325} = 0$
Species	$F_{C316}^i + F_{C329}^i - F_{C317}^i - F_{C325}^i = 0$ where $i=1,3,4,5$
Smith- Brinkley Method Equations	
	$K_i = f(P_{C603}, T_n)$ $K'_i = f(P_{C603}, T_m)$ $S_{n,i} = \frac{K_i F_{C325}}{F_{C329}}$ $S_{m,i} = \frac{K'_i V'}{L}$ $f_i = \frac{(1 + S_{n,i}^{N-M}) + R(1 - S_{n,i})}{(1 + S_{n,i}^{N-M}) + R(1 - S_{n,i}) + h_i S_{n,i}^{N-M} (1 - S_{m,i}^{M+1})}$ $f_i = \frac{F_{C317}^i}{F_{C316}^i}$ $h_i = \frac{K'_i L}{K_i L'} \left( \frac{1 - S_n}{1 - S_m} \right)_i$ <p>where <math>i=1,3,4,5,7</math></p> $x_{C317}^i - x_{C323}^i = 0, \text{ where } i=1,3,4,5$ $T_{C317} - T_{C323} = 0$

Table A.4. Constraint Equations for Alkylate Deisobutanizer (5C-606)

Material Balances	
Overall	$F_{C404} + F_{C432} + F_{C322} - F_{C414} - F_{C430} = 0$ $F_{C430} + F_{C427} - F_{C431} - F_{C425} = 0$ $F_{C426} - F_{C428} - F_{C405} = 0$ $F_{C427} - F_{C431} = 0$ $F_{C425} - F_{C430} = 0$
Species	$F_{C404}^i + F_{C432}^i + F_{C322}^i - F_{C414}^i - F_{C430}^i = 0$ $F_{C430}^i + F_{C427}^i - F_{C431}^i - F_{C425}^i = 0$ $F_{C426}^i - F_{C428}^i - F_{C405}^i = 0$ <p>where <math>i=1,3,4,5</math></p>
Smith- Brinkley Method Equations	
	$K_{i,C606A} = f(P_{C606A}, T_{n,C606A})$ $K'_{i,C606A} = f(P_{C606A}, T_{m,C606A})$ $K_{i,C606C} = f(P_{C606C}, T_{C425})$ $K'_{i,C606D} = f(P_{C606D}, T_{m,C606D})$ $S_{m,i,C606A} = \frac{K'_{i,C606A} V'_{C606A}}{L'_{C606A}}$ $S_{n,i,C606A} = \frac{K_{i,C606A} F_{C414}}{F_{C322}}$ $S_{m,i,C606D} = \frac{K_{i,C428} F_{C428}}{F_{C426}}$



Table A.5. Constraint Equations for Alkylate Deisobutanizer (5C-606)

Smith- Brinkley Method Equations

$$f_{i,C606A} = \frac{(1 - S_{n,i,C606A}^{N-M}) + q_{i,C606A}^S (S_{n,i,C606A}^{N-M} - S_{n,i,C606A}) + q_{i,C606A}^F h_{i,C606A} S_{n,i,C606A}^{N-M} (1 - S_{m,i,C606A}^M)}{(1 - S_{n,i,C606A}^{N-M}) + h_{i,C606A} S_{n,i,C606A}^{N-M} (1 - S_{m,i,C606A}^{M+1})}$$

$$f_{i,C606A} = \frac{F_{C430}^i}{(F_{C404}^i + F_{C322}^i + F_{C432}^i)}$$

$$h_{i,C606A} = \frac{F_{C322}}{L_{C606A}} \left( \frac{1 - S_{n,C606A}}{1 - S_{m,C606A}} \right)_i$$

$$x_{i,C606D}^M = \frac{F_{C428} K'_{i,C606D} (S_{m,i,C606D}^{M-1} - 1) + F_{C426} (S_{m,i,C606D} - 1)}{F_{C426}^2 (S_{m,i,C606D} - 1)}$$

where  $i=1,3,4,5,7$

$$x x_{C425}^i K_{C606C}^i - x x_{C431}^i = 0, \text{ where } i=1,3,4,5$$

$$x_{C408}^i - x_{C405}^i = 0, \text{ where } i=1,3,4,5$$

$$L_{C606A} = F_{C322} + q_{C606A} F_{C404}$$

$$V_{C606A} = F_{C432}$$

$$T_{C431} - T_{C425} = 0$$

Table A.6. Constraint Equations for the **suction trap/flash drum model(5c-614)**

Material Balances	
Overall	$(F_{HC31l} + F_{HC31v}) - (F_{C401} + F_{C301}) = 0$ $F_{HC31l} - F_{C401} = 0$ $F_{C311} - F_{HC32} - F_{C302} = 0$
Species	$(F_{HC31l}^i + F_{HC31v}^i) - (F_{C401}^i + F_{C301}^i) = 0$ $F_{HC31l}^i - F_{C401}^i = 0$ $F_{C311}^i - F_{HC32}^i - F_{C302}^i = 0, \text{ where } i=1,3,4,5,7$ $K_i = \frac{y_i}{x_i}, \text{ where, } \sum x_i = 1, \sum y_i = 1$
Energy Balances	
	$T_{HC31} = T_{C301} = T_{C401}$ $h_{C311} - h_{HC32} - h_{C302} = 0$

table A.7. Constraint Equations for the **suction trap/flash drum model(5C-614)**

Material Balances	
Overall	$F_{C309} - F_{C310} - F_{C311} = 0$
Component material balance:	$F_{C309}^i - F_{C310}^i - F_{C311}^i = 0$ $K_i = \frac{y_i}{x_i}, \text{ where, } \sum x_i = 1, \sum y_i = 1$ <p>In the above equation, <math>K_i</math> is the distribution coefficient or the K-factor, <math>y_i</math> is the mole fraction of component i in the vapor phase, and <math>x_i</math> is that in the liquid phase.</p>
Enthalpy balance:	$h_{C309} - h_{C310} - h_{C311} = 0$ <p>where, <math>h_X</math> is the enthalpy of stream X.</p>

Table A.8. Constraint equations for **Compressor (5K-601)**

Material Balances	
Overall	$F_{C303} + F_{C310} - F_{C304} = 0$
Species	$F_{C303}^i + F_{C310}^i - F_{C304}^i = 0$ where $i=1,3,4,5$
Energy Balances	
	$h_{C303} + h_{C310} + hp_{ad} - h_{C304} = 0$ $T_2 = T_1 \left( \frac{p_2}{p_1} \right)^{\frac{(k-1)}{k}}$ $hp_{ad} = \frac{k}{k-1} \frac{8.314 F_{C306} T_{C303}}{55} \left[ \left( \frac{p_2}{p_1} \right)^{\frac{(k-1)}{k}} - 1 \right]$

Table A.9. Constraint equations for **Olefin Feed Effluent Exchanger (5E-628)**

Material Balances	
Overall	$F_{HC01} + F_{HC02} = 0$ $F_{C401} + F_{C402} = 0$
Species	$x_{HC01}^i + x_{HC02}^i = 0$ $x_{C401}^i + x_{C402}^i = 0$ <p>where <math>i = 1,2,3,4,5</math></p>
Energy Balances	
	$(h_{HC02} - h_{HC01}) - (h_{C401} - h_{C402}) = 0$ $(h_{HC01} - h_{HC02}) - U_{5E628} A_{5E628} \Delta T_{lm} = 0$ $\Delta T_{lm} = \frac{(T_{HC02} - T_{C401}) - (T_{HC01} - T_{C402})}{\ln \frac{(T_{HC02} - T_{C401})}{(T_{HC01} - T_{C402})}}$

## APPENDIX B

### Full Output File for Economic Optimization of Online Optimization for Motiva Alkylation Process

Economic Optimization Program

05/15/01 16:49:39 PAGE 1  
GAMS 2.50A Windows NT/95/98

```
2
5
6 SCALARS
7 MW1 / 44.1 /
8 MW2 / 56.1 /
9 MW3 / 58.1 /
10 MW4 / 58.1 /
11 MW5 / 72.1 /
12 MW6 / 72.1 /
13 MW7 / 86.2 /
14 MW8 / 100.2 /
15 MW9 / 114.2 /
16 MW10 / 128.2 /
17 MW11 / 98 /
18 MWIC10 / 142 /
19 MWIC11 / 156 /
20 ;
21
22 SCALARS
23 klav / 120000 /
24 Vr / 87.06 /
25 k1 / 6770 /
26 k2 / 13797000000 /
27 k3 / 4970000000 /
28 k4 / 1929700000 /
29 k5 / 1420300000 /
30 k6 / 5370200000 /
31 k7 / 4290200000 /
32 k8 / 4720300000 /
33 k9 / 1210000 /
34 k10 / 396000000000000 /
35 k11 / 401000000000000 /
36 k12 / 19971000 /
37 k13 / 4.02E+16 /
38 k14 / 96770000 /
39 k15 / 8.45E+15 /
40 k16 / 8.006E+16 /
41 k17 / 213740000 /
42 k18 / 3780100000 /
43 k19 / 1.231E+15 /
44 VaC623 / 46.1 /
45 Ha / 0.53 /
46 ;
47 SCALARS
48 AE601 / 81 /
49 AE602 / 365 /
```

Economic Optimization Program

05/15/01 16:49:39 PAGE 2  
GAMS 2.50A Windows NT/95/98

```
50 AE603 / 98 /
51 AE605 / 428 /
52 AE609A / 33 /
53 AE610 / 150.5 /
54 AE611 / 110.55 /
55 AE612 / 263.84 /
56 AE613 / 431.07 /
57 AE616 / 106 /
58 AE617 / 106 /
59 AE621A / 346 /
60 AE626 / 308 /
61 AE627A / 42 /
62 AE628 / 88.7 /
63 AE629 / 743 /
64 AE633 / 284 /
65 AE634 / 3820 /
66 AE640 / 282.42 /
67 AE641 / 133.8 /
68 AE695A / 310 /
69 AE696A / 393 /
70 ContrA / 2.2 /
71 AE6XX / 7360 /
72 AE621B / 115 /
73 AE627B / 41 /
74 AE696B / 131 /
75 AE695B / 103 /
76 ;
77 SCALARS
78 E01MTD / 40.2 /
79 E02MTD / 114.5 /
```

80 E03MTD / 24.3 /  
81 E05MTD / 27.1 /  
82 E09MTD / 19.9 /  
83 E10MTD / 35.8 /  
84 E11MTD / 19.8 /  
85 E12MTD / 75.5 /  
86 E13MTD / 21.5 /  
87 E16MTD / 140.2 /  
88 E17MTD / 29.1 /  
89 E21MTD / 25.6 /  
90 E26MTD / 15.4 /  
91 E27MTD / 44.5 /  
92 E28MTD / 36.1 /  
93 E29MTD / 16.4 /  
94 E33MTD / 20.4 /  
95 E34MTD / 19.3 /  
\_Economic Optimization Program

05/15/01 16:49:39 PAGE 3  
GAMS 2.50A Windows NT/95/98

96 E40MTD / 13.6 /  
97 E41MTD / 15.7 /  
98 E95MTD / 59.2 /  
99 E96MTD / 70.4 /  
100 ;  
101 SCALARS  
102 C06AN / 9 /  
103 C06BN / 34 /  
104 C06CN / 2 /  
105 C06DN / 9 /  
106 C03N / 40 /  
107 C03M / 21 /  
108 C01N / 60 /  
109 C01M / 41 /  
110 ;  
111 SCALARS  
112 R / 0.0083144 /  
113 H298\_1 /-12590 /  
114 H298\_2 /-64.95 /  
115 H298\_3 /-16240 /  
116 H298\_4 /-15130 /  
117 H298\_5 /-18490 /  
118 H298\_6 /-17650 /  
119 H298\_7 / 28980 /  
120 H298\_8 / 33220 /  
121 H298\_9 /-26940 /  
122 H298\_10 /-4454 /  
123 b\_1 /-14380 /  
124 b\_2 /-2115 /  
125 b\_3 /-18460 /  
126 b\_4 /-17590 /  
127 b\_5 /-20810 /  
128 b\_6 /-20090 /  
129 b\_7 /-542.63 /  
130 b\_8 /-26770 /  
131 b\_9 /-30480 /  
132 b\_10 /-8684 /  
133 kK601 / 1.12 /  
134 WK601 / 460 /  
135 hsteam / 1946.60928 /  
136 hwatin / 112 /  
137 hsteam397 / 1736 /  
138 ;  
139 SCALARS  
140 C03Kn1 / 1.3 /  
141 C03Kn2 / 0.65 /  
\_Economic Optimization Program

05/15/01 16:49:39 PAGE 4  
GAMS 2.50A Windows NT/95/98

142 C03Kn3 / 0.62 /  
143 C03Kn4 / 0.46 /  
144 C03Kn5 / 0.22 /  
145 C03Kn6 / 0.18 /  
146 C03Kn7 / 0.1 /  
147 C03Kn8 / 0.045 /  
148 C03Kn9 / 0.02 /  
149 C03Kn10 / 0.005 /  
150 C03Km1 / 1.75 /  
151 C03Km2 / 0.93 /  
152 C03Km3 / 0.9 /  
153 C03Km4 / 0.7 /  
154 C03Km5 / 0.35 /  
155 C03Km6 / 0.3 /  
156 C03Km7 / 0.18 /  
157 C03Km8 / 0.07 /  
158 C03Km9 / 0.035 /  
159 C03Km10 / 0.012 /  
160 C01Kn1 / 1.8 /  
161 C01Kn2 / 0.75 /  
162 C01Kn3 / 0.8 /  
163 C01Kn4 / 0.6 /

164 C01Kn5 / 0.26 /  
165 C01Kn6 / 0.22 /  
166 C01Kn7 / 0.09 /  
167 C01Kn8 / 0.04 /  
168 C01Kn9 / 0.018 /  
169 C01Kn10 / 0.005 /  
170 C01Km1 / 2.1 /  
171 C01Km2 / 0.85 /  
172 C01Km3 / 1 /  
173 C01Km4 / 0.7 /  
174 C01Km5 / 0.35 /  
175 C01Km6 / 0.28 /  
176 C01Km7 / 0.15 /  
177 C01Km8 / 0.05 /  
178 C01Km9 / 0.025 /  
179 C01Km10 / 0.008 /  
180 K1C616 / 3.5 /  
181 K2C616 / 1.7 /  
182 K3C616 / 1.4 /  
183 K4C616 / 0.95 /  
184 K5C616 / 0.4 /  
185 K6C616 / 0.3 /  
186 K7C616 / 0.13 /  
187 K8C616 / 0.04 /  
\_Economic Optimization Program

05/15/01 16:49:39 PAGE 5  
GAMS 2.50A Windows NT/95/98

188 K9C616 / 0.015 /  
189 K10C616 / 0.0045 /  
190 C14K1 / 3.4 /  
191 C14K2 / 1.2 /  
192 C14K3 / 1.1 /  
193 C14K4 / 0.75 /  
194 C14K5 / 0.23 /  
195 C14K6 / 0.16 /  
196 C14K7 / 0.05 /  
197 C14K8 / 0.011 /  
198 C14K9 / 0.004 /  
199 C14K10 / 0.0008 /  
200 K1C615 / 2.2 /  
201 K2C615 / 1.2 /  
202 K3C615 / 1 /  
203 K4C615 / 0.7 /  
204 K5C615 / 0.3 /  
205 K6C615 / 0.25 /  
206 K7C615 / 0.13 /  
207 K8C615 / 0.045 /  
208 K9C615 / 0.02 /  
209 K10C615 / 0.006 /  
210 RK1 / 5 /  
211 RK2 / 2 /  
212 RK3 / 1.7 /  
213 RK4 / 1.35 /  
214 RK5 / 0.41 /  
215 RK6 / 0.3 /  
216 RK7 / 0.1 /  
217 RK8 / 0.03 /  
218 RK9 / 0.01 /  
219 RK10 / 0.003 /  
220 K1M3 / 3.71 /  
221 K2M3 / 1.05 /  
222 K3M3 / 1.25 /  
223 K4M3 / 0.82 /  
224 K5M3 / 0.28 /  
225 K6M3 / 0.24 /  
226 K7M3 / 0.068 /  
227 K8M3 / 0.025 /  
228 K9M3 / 0.0075 /  
229 K10M3 / 0.0025 /  
230 C06Am / 0.9 /  
231 C06Bm / 1.2 /  
232 C06Cm / 1.1 /  
233 C06Dm / 2.9 /  
\_Economic Optimization Program

05/15/01 16:49:39 PAGE 6  
GAMS 2.50A Windows NT/95/98

234 ;  
235 SCALARS  
236 AC07dens / 115.37 /  
237 AC08dens / 115.37 /  
238 AC18dens / 115.05 /  
239 AC19dens / 115.05 /  
240 AC29dens / 114.6 /  
241 AC30dens / 114.6 /  
242 AC40dens / 114.3 /  
243 AC41dens / 114.3 /  
244 HCdens1 / 0.002055 /  
245 HCdens2 / 0.002543 /  
246 HCdens3 / 0.002301 /  
247 HCdens4 / 0.002389 /



248 Hcdens5 / 0.002568 /  
 249 Hcdens6 / 0.002589 /  
 250 Hcdens7 / 0.002702 /  
 251 Hcdens8 / 0.00281 /  
 252 Hcdens9 / 0.002902 /  
 253 Hcdens10 / 0.00296 /  
 254 ;  
 255 SCALARS  
 256 wat1 / 1.0861707 /  
 257 wat2 / 0.000563134 /  
 258 wat3 / 0.00000834491 /  
 259 wat4 / 11426.6 /  
 260 wat5 / 1018240 /  
 261 ;  
 262 SCALARS  
 263 KdiC4 / 0.0007 /  
 264 KdiC5 / 0.00056 /  
 265 KdiC6 / 0.00047 /  
 266 KdiC7 / 0.000407 /  
 267 KdiC8 / 0.000356 /  
 268 KdiC9 / 0.000317 /  
 269 ;  
 270  
 271 \* The following are the Measured Variables  
 272 VARIABLES  
 273 FAC02, FAC12, FAC23, FAC34, FAC45, FC308, FC316, FC320,  
 274 FC322, FC328, FC329, FC403, FC407, FC412, FC417, FHC01,  
 275 FHC32, FSC402, FSC405, FSC411, FSC413, FstmE612, PC302, PC310,  
 276 PC601, PC603, QHC07, QHC11, QHC14, QHC16, QHC34, QHC38,  
 277 QHC41, QHC45, TAC09, TAC12, TAC23, TAC31, TAC34, TAC42,  
 278 TAC45, TC303, TC306, TC307, TC308, TC315, TC316, TC317,  
 279 TC321, TC324, TC325, TC404, TC405, TC407, TC408, TC410,  
 \_Economic Optimization Program

05/15/01 16:49:39 PAGE 7  
GAMS 2.50A Windows NT/95/98

280 TC414, TC418, TC419, THC32, TSC402, TSC403, TSC405, TSC408,  
 281 TSC413, x11AC12, x11AC23, x11AC34, x11AC45, x1C316, x1C325, x1C417,  
 282 x1HC32, x1SC402, x1SC403, x1SC408, x2SC402, x2SC403, x2SC408, x3C316,  
 283 x3C325, x3C417, x3HC32, x3SC402, x3SC403, x3SC408, x4C316, x4C417,  
 284 x4HC32, x4SC402, x4SC403, x4SC408, x5C316, x5C417, x5HC32, x5SC402,  
 285 x5SC403, x5SC408, x6SC402, x6SC403, x6SC408, x7HC32, x7SC402, x7SC403,  
 286 x7SC408, xx1C322, xx1C414, xx1HC01, xx2HC01, xx3C317, xx3C322, xx3C407,  
 287 xx3C412, xx3C414, xx3HC01, xx4C317, xx4C322, xx4C407, xx4C412, xx4C414,  
 288 xx4HC01, xx5C407, xx5C412, xx5C414, xx7C414;  
 289  
 290 VARIABLE ObjVar objective or profit function;  
 291 \* The following are the Unmeasured Variables  
 292 VARIABLES  
 293 C10pC623, C10pC625, C10pC627, C10pC629, C2C623, C2C625, C2C627, C2C629,  
 294 C3C623, C3C625, C3C627, C3C629, C3pC623, C3pC625, C3pC627, C3pC629,  
 295 C4pC623, C4pC625, C4pC627, C4pC629, C5pC623, C5pC625, C5pC627, C5pC629,  
 296 C7pC623, C7pC625, C7pC627, C7pC629, C8pC623, C8pC625, C8pC627, C8pC629,  
 297 C9pC623, C9pC625, C9pC627, C9pC629, CHXC623, CHXC625, CHXC627, CHXC629,  
 298 CiC10pC623, CiC10pC625, CiC10pC627, CiC10pC629, CiC11pC623, CiC11pC625, CiC11pC627,  
 299 CiC4eC623, CiC4eC625, CiC4eC627, CiC4eC629, CiC5eC623, CiC5eC625, CiC5eC627, CiC5eC629,  
 300 CiC8eC623, CiC8eC625, CiC8eC627, CiC8eC629, Cost, dTE601, dTE602, dTE603,  
 301 dTE605, dTE609A, dTE610, dTE611, dTE612, dTE613, dTE616, dTE617,  
 302 dTE621A, dTE621B, dTE626, dTE627A, dTE627B, dTE628, dTE629, dTE633,  
 303 dTE634, dTE640, dTE641, dTE695A, dTE695B, dTE696A, dTE696B, dTE69X,  
 304 Earnings, f1C601, f1C603, f1C606A, f2C601, f3C601, f3C603, f3C606A,  
 305 f4C601, f4C603, f4C606A, f5C601, f5C603, f5C606A, f6C601, f7C601,  
 306 f7C603, f7C606A, FAC05, FAC07, FAC09, FAC15, FAC18, FAC20,  
 307 FAC26, FAC29, FAC31, FAC37, FAC40, FAC42, FC301, FC302,  
 308 FC303, FC306, FC307, FC309, FC310, FC311, FC312, FC315,  
 309 FC317, FC318, FC319, FC321, FC323, FC324, FC325, FC326,  
 310 FC401, FC402, FC404, FC405, FC406, FC408, FC409, FC410,  
 311 FC411, FC413, FC414, FC415, FC418, FC419, FC425, FC426,  
 312 FC427, FC428, FC430, FC431, FC432, FcwE603, FcwE605, FcwE609A,  
 313 FcwE611, FcwE613, FcwE617, FcwE621A, FcwE621B, FcwE626, FcwE627A, FcwE627B,  
 314 FcwE634, FcwE640, FcwE641A, FcwE641B, FHC02, FHC03, FHC04, FHC05,  
 315 FHC06, FHC07, FHC08, FHC11, FHC14, FHC15, FHC16, FHC22,  
 316 FHC23, FHC24, FHC25, FHC26, FHC27, FHC28, FHC29, FHC30,  
 317 FHC31, FHC33, FHC34, FHC38, FHC40, FHC41, FHC45, FIHC28,  
 318 FIHC29, FIHC30, FIHC31, FIR1, FIR29, FmC302, FmC308, FmC310,  
 319 FmC311, FmC312, FmC317, FmC322, FmC323, FmC325, FmC405, FmC407,  
 320 FmC408, FmC409, FmC412, FmC414, FmC425, FmC427, FmC428, FmC430,  
 321 FmC431, FmC432, FmHC01, FmHC32, FmIHC28, FmIHC29, FmIHC30, FmIR1,  
 322 FmIR29, FmSC403, FmSC406, FmSC408, FmvHC28, FmvHC29, FmvHC30, FmvR1,  
 323 FmvR29, FR1, FR29, FSC401, FSC403, FSC404, FSC406, FSC407,  
 324 FSC408, FSC409, FSC412, FSC414, FstmE602, FstmE695A, FstmE695B, FstmE696A,  
 325 FstmE696B, FvHC28, FvHC29, FvHC30, FvHC31, FvR1, FvR29, h1C601,  
 \_Economic Optimization Program

05/15/01 16:49:39 PAGE 8  
GAMS 2.50A Windows NT/95/98

326 h1C603, h1C606A, h2C601, h3C601, h3C603, h3C606A, h4C601, h4C603,  
 327 h4C606A, h5C601, h5C603, h5C606A, h6C601, h7C601, h7C603, h7C606A,  
 328 hAC02, hAC05, hAC07, hAC09, hAC12, hAC15, hAC18, hAC20,  
 329 hAC23, hAC26, hAC29, hAC31, hAC34, hAC37, hAC40, hAC42,  
 330 hacAC09, hacAC20, hacAC31, hacAC42, hC301, hC302, hC303, hC306,  
 331 hC307, hC308, hC309, hC310, hC311, hC312, hC312liq, hC315,

332 hC316, hC317, hC318, hC319, hC321, hC322, hC323, hC324,  
333 hC325, hC326, hC329, hC401, hC402, hC403, hC404, hC405,  
334 hC406, hC407, hC408, hC408vap, hC409, hC410, hC410vap, hC411,  
335 hC412, hC412liq, hC413, hC414, hC414liq, hC415, hC417, hC418,  
336 hC419, hC425, hC426, hC427, hC428, hC430, hC431, hC432,  
337 hC623, hC625, hC627, hC629, hHC01, hHC02, hHC03, hHC04,  
338 hHC05, hHC06, hHC07, hHC11, hHC14, hHC16, hHC29, hHC30,  
339 hHC31, hHC32, hHC34, hHC38, hHC41, hHC45, hHC29, hHC30,  
340 hHC31, hIR1, hIR29, hR1, hR29, hSC401, hSC402, hSC403,  
341 hSC404, hSC405, hSC406, hSC407, hSC408, hSC409, hSC411, hSC412,  
342 hSC413, hSC414, hvHC29, hvHC30, hvHC31, hvR1, hvR29, K1C323,  
343 K1C325, K1C408, K1C414, K1C428, K1C430, K1C601, K1C603, K1C606A,  
344 K1C606C, K1C614B, K1C615\_A, K1C616\_A, K1E633, K1E6XX, K1SC406, K1SC408,  
345 K2C601, K2E633, K2E6XX, K2SC406, K2SC408, K3C323, K3C325, K3C408,  
346 K3C414, K3C428, K3C430, K3C601, K3C603, K3C606A, K3C606C, K3C614B,  
347 K3C615\_A, K3C616\_A, K3E633, K3E6XX, K3SC406, K3SC408, K4C323, K4C325,  
348 K4C408, K4C414, K4C428, K4C430, K4C601, K4C603, K4C606A, K4C606C,  
349 K4C614B, K4C615\_A, K4C616\_A, K4E633, K4E6XX, K4SC406, K4SC408, K5C323,  
350 K5C325, K5C408, K5C414, K5C428, K5C430, K5C601, K5C603, K5C606A,  
351 K5C606C, K5C614B, K5C615\_A, K5C616\_A, K5E633, K5E6XX, K5SC406, K5SC408,  
352 K6C601, K6SC406, K6SC408, K7C323, K7C325, K7C408, K7C414, K7C428,  
353 K7C430, K7C601, K7C603, K7C606A, K7C614B, K7C615\_A, K7C616\_A, K7E633,  
354 K7E6XX, K7SC406, K7SC408, Kp1C601, Kp1C603, Kp1C606A, Kp1C606D, Kp2C601,  
355 Kp3C601, Kp3C603, Kp3C606A, Kp3C606D, Kp4C601, Kp4C603, Kp4C606A, Kp4C606D,  
356 Kp5C601, Kp5C603, Kp5C606A, Kp5C606D, Kp6C601, Kp7C601, Kp7C603, Kp7C606A,  
357 Kp7C606D, kWad1, kWad2, LpC601, LpC603, LpC606A, PC303, PC306,  
358 PC307, PC308, PC309, PC311, PC312, PHC30, PHC32, PR29,  
359 Profit, Q2HC07, Q2HC11, Q2HC14, Q2HC16, qFp1C606A, qFp3C606A, qFp4C606A,  
360 qFp5C606A, qFp7C606A, qS1C606A, qS3C606A, qS4C606A, qS5C606A, r10C623,  
361 r10C625, r10C627, r10C629, r2C623, r2C625, r2C627, r2C629, r3C623,  
362 r3C625, r3C627, r3C629, r4C623, r4C625, r4C627, r4C629, r5C623,  
363 r5C625, r5C627, r5C629, r7C623, r7C625, r7C627, r7C629, r8C623,  
364 r8C625, r8C627, r8C629, r9C623, r9C625, r9C627, r9C629, rho2HC07,  
365 rho2HC11, rho2HC14, rho2HC16, rhoAC09, rhoAC20, rhoAC31, rhoAC42, riC10C623,  
366 riC10C625, riC10C627, riC10C629, riC11C623, riC11C625, riC11C627, riC11C629, sf1S34,  
367 sf2S34, sfS11, sfS19, sfS2, sfS23, sfS27, sfS41, sfS42,  
368 sfS5, sfS7, Sm1C601, Sm1C603, Sm1C606A, Sm1C606D, Sm2C601, Sm3C601,  
369 Sm3C603, Sm3C606A, Sm3C606D, Sm4C601, Sm4C603, Sm4C606A, Sm4C606D, Sm5C601,  
370 Sm5C603, Sm5C606A, Sm5C606D, Sm6C601, Sm7C601, Sm7C603, Sm7C606A, Sm7C606D,  
371 Sn1C601, Sn1C603, Sn1C606A, Sn2C601, Sn3C601, Sn3C603, Sn3C606A, Sn4C601,  
\_Economic Optimization Program 05/15/01 16:49:39 PAGE 9  
GAMS 2.50A Windows NT/95/98

372 Sn4C603, Sn4C606A, Sn5C601, Sn5C603, Sn5C606A, Sn6C601, Sn7C601, Sn7C603,  
373 Sn7C606A, TAC02, TAC05, TAC07, TAC15, TAC18, TAC20, TAC26,  
374 TAC29, TAC37, TAC40, TC301, TC302, TC309, TC310, TC311,  
375 TC312, TC318, TC319, TC320, TC322, TC323, TC326, TC328,  
376 TC329, TC401, TC402, TC403, TC406, TC409, TC411, TC412,  
377 TC413, TC415, TC417, TC425, TC426, TC427, TC428, TC430,  
378 TC431, TC432, TcwortE609A, TcwortE621A, TcwortE621B, TcwortE627A, TcwortE627B, TcwortE641A,  
379 TcwortE641B, TcwortE603, TcwortE605, TcwortE611, TcwortE613, TcwortE617, TcwortE626, TcwortE634,  
380 TcwortE640, THC01, THC02, THC03, THC04, THC05, THC06, THC07,  
381 THC11, THC14, THC16, THC22, THC23, THC24, THC25, THC26,  
382 THC27, THC28, THC29, THC30, THC31, THC34, THC38, THC41,  
383 THC45, TmC601, TmC603, TmC606A, TmC606D, TmK601, TnC601, TnC603,  
384 TnC606A, TR1, TR29, TSC401, TSC404, TSC406, TSC407, TSC409,  
385 TSC411, TSC412, TSC414, Utilities, VFC614B, VFC615, VFC616, VFM3,  
386 VpC601, VpC603, VpC606A, x10AC09, x10AC20, x10AC31, x10AC42, x11AC02,  
387 x11AC05, x11AC07, x11AC09, x11AC15, x11AC18, x11AC20, x11AC26, x11AC29,  
388 x11AC31, x11AC37, x11AC40, x11AC42, x12AC02, x12AC05, x12AC07, x12AC09,  
389 x12AC12, x12AC15, x12AC18, x12AC20, x12AC23, x12AC26, x12AC29, x12AC31,  
390 x12AC34, x12AC37, x12AC40, x12AC42, x12AC45, x1AC09, x1AC20, x1AC31,  
391 x1AC42, x1C301, x1C302, x1C303, x1C306, x1C307, x1C308, x1C309,  
392 x1C310, x1C311, x1C312, x1C315, x1C317, x1C318, x1C319, x1C320,  
393 x1C321, x1C322, x1C323, x1C324, x1C326, x1C328, x1C329, x1C401,  
394 x1C402, x1C403, x1C404, x1C405, x1C406, x1C407, x1C408, x1C409,  
395 x1C410, x1C411, x1C412, x1C413, x1C414, x1C415, x1C418, x1C419,  
396 x1C425, x1C426, x1C427, x1C428, x1C430, x1C431, x1C432, x1HC01,  
397 x1HC02, x1HC03, x1HC04, x1HC05, x1HC06, x1HC07, x1HC08, x1HC11,  
398 x1HC14, x1HC15, x1HC16, x1HC22, x1HC23, x1HC24, x1HC25, x1HC26,  
399 x1HC27, x1HC28, x1HC29, x1HC30, x1HC31, x1HC33, x1HC34, x1HC38,  
400 x1HC40, x1HC41, x1HC45, x1R1, x1R29, x1SC401, x1SC404, x1SC405,  
401 x1SC406, x1SC407, x1SC409, x1SC411, x1SC412, x1SC413, x1SC414, x2AC09,  
402 x2AC20, x2AC31, x2AC42, x2C301, x2C417, x2C418, x2C419, x2HC01,  
403 x2HC02, x2HC03, x2HC04, x2HC05, x2HC06, x2HC07, x2HC08, x2HC11,  
404 x2HC14, x2HC15, x2HC16, x2HC22, x2HC23, x2HC24, x2HC25, x2HC26,  
405 x2HC27, x2HC28, x2HC29, x2HC30, x2HC31, x2R1, x2R29, x2SC401,  
406 x2SC404, x2SC405, x2SC406, x2SC407, x2SC409, x2SC411, x2SC412, x2SC413,  
407 x2SC414, x3AC09, x3AC20, x3AC31, x3AC42, x3C301, x3C302, x3C303,  
408 x3C306, x3C307, x3C308, x3C309, x3C310, x3C311, x3C312, x3C315,  
409 x3C317, x3C318, x3C319, x3C320, x3C321, x3C322, x3C323, x3C324,  
410 x3C326, x3C328, x3C329, x3C401, x3C402, x3C403, x3C404, x3C405,  
411 x3C406, x3C407, x3C408, x3C409, x3C410, x3C411, x3C412, x3C413,  
412 x3C414, x3C415, x3C418, x3C419, x3C425, x3C426, x3C427, x3C428,  
413 x3C430, x3C431, x3C432, x3HC01, x3HC02, x3HC03, x3HC04, x3HC05,  
414 x3HC06, x3HC07, x3HC08, x3HC11, x3HC14, x3HC15, x3HC16, x3HC22,  
415 x3HC23, x3HC24, x3HC25, x3HC26, x3HC27, x3HC28, x3HC29, x3HC30,  
416 x3HC31, x3HC33, x3HC34, x3HC38, x3HC40, x3HC41, x3HC45, x3R1,  
417 x3R29, x3SC401, x3SC404, x3SC405, x3SC406, x3SC407, x3SC409, x3SC411,  
\_Economic Optimization Program 05/15/01 16:49:39 PAGE 10  
GAMS 2.50A Windows NT/95/98

418 x3SC412, x3SC413, x3SC414, x4AC09, x4AC20, x4AC31, x4AC42, x4C301,  
419 x4C302, x4C303, x4C306, x4C307, x4C308, x4C309, x4C310, x4C311,  
420 x4C312, x4C315, x4C317, x4C318, x4C319, x4C320, x4C321, x4C322,  
421 x4C323, x4C324, x4C325, x4C326, x4C328, x4C329, x4C401, x4C402,  
422 x4C403, x4C404, x4C405, x4C406, x4C407, x4C408, x4C409, x4C410,  
423 x4C411, x4C412, x4C413, x4C414, x4C415, x4C418, x4C419, x4C425,  
424 x4C426, x4C427, x4C428, x4C430, x4C431, x4C432, x4HC01, x4HC02,  
425 x4HC03, x4HC04, x4HC05, x4HC06, x4HC07, x4HC08, x4HC11, x4HC14,  
426 x4HC15, x4HC16, x4HC22, x4HC23, x4HC24, x4HC25, x4HC26, x4HC27,  
427 x4HC28, x4HC29, x4HC30, x4HC31, x4HC33, x4HC34, x4HC38, x4HC40,  
428 x4HC41, x4HC45, x4R1, x4R29, x4SC401, x4SC404, x4SC405, x4SC406,  
429 x4SC407, x4SC409, x4SC411, x4SC412, x4SC413, x4SC414, x5AC09, x5AC20,  
430 x5AC31, x5AC42, x5C301, x5C302, x5C303, x5C306, x5C307, x5C308,  
431 x5C309, x5C310, x5C311, x5C312, x5C315, x5C317, x5C318, x5C319,  
432 x5C320, x5C321, x5C322, x5C323, x5C324, x5C325, x5C326, x5C328,  
433 x5C329, x5C401, x5C402, x5C403, x5C404, x5C405, x5C406, x5C407,  
434 x5C408, x5C409, x5C410, x5C411, x5C412, x5C413, x5C414, x5C415,  
435 x5C418, x5C419, x5C425, x5C426, x5C427, x5C428, x5C430, x5C431,  
436 x5C432, x5HC01, x5HC02, x5HC03, x5HC04, x5HC05, x5HC06, x5HC07,  
437 x5HC08, x5HC11, x5HC14, x5HC15, x5HC16, x5HC22, x5HC23, x5HC24,  
438 x5HC25, x5HC26, x5HC27, x5HC28, x5HC29, x5HC30, x5HC31, x5HC33,  
439 x5HC34, x5HC38, x5HC40, x5HC41, x5HC45, x5R1, x5R29, x5SC401,  
440 x5SC404, x5SC405, x5SC406, x5SC407, x5SC409, x5SC411, x5SC412, x5SC413,  
441 x5SC414, x6SC401, x6SC404, x6SC405, x6SC406, x6SC407, x6SC409, x6SC411,  
442 x6SC412, x6SC413, x6SC414, x7AC09, x7AC20, x7AC31, x7AC42, x7C301,  
443 x7C302, x7C303, x7C306, x7C307, x7C308, x7C309, x7C310, x7C311,  
444 x7C312, x7C315, x7C316, x7C317, x7C318, x7C319, x7C320, x7C321,  
445 x7C322, x7C323, x7C324, x7C325, x7C326, x7C328, x7C329, x7C401,  
446 x7C402, x7C403, x7C404, x7C405, x7C406, x7C407, x7C408, x7C409,  
447 x7C410, x7C411, x7C412, x7C413, x7C414, x7C415, x7C417, x7C418,  
448 x7C419, x7C425, x7C426, x7C427, x7C428, x7C430, x7C431, x7C432,  
449 x7HC01, x7HC02, x7HC03, x7HC04, x7HC05, x7HC06, x7HC07, x7HC08,  
450 x7HC11, x7HC14, x7HC15, x7HC16, x7HC22, x7HC23, x7HC24, x7HC25,  
451 x7HC26, x7HC27, x7HC28, x7HC29, x7HC30, x7HC31, x7HC33, x7HC34,  
452 x7HC38, x7HC40, x7HC41, x7HC45, x7R1, x7R29, x7SC401, x7SC404,  
453 x7SC405, x7SC406, x7SC407, x7SC409, x7SC411, x7SC412, x7SC413, x7SC414,  
454 x8AC09, x8AC20, x8AC31, x8AC42, x9AC09, x9AC20, x9AC31, x9AC42,  
455 xAC02, xAC05, xAC07, xAC09, xAC12, xAC15, xAC18, xAC20,  
456 xAC23, xAC26, xAC29, xAC31, xAC34, xAC37, xAC40, xAC42,  
457 xiC10AC09, xiC10AC20, xiC10AC31, xiC10AC42, xiC11AC09, xiC11AC20, xiC11AC31, xiC11AC42,  
458 xM1C606D, xM3C606D, xM4C606D, xM5C606D, xM7C606D, xx1C302, xx1C308, xx1C310,  
459 xx1C311, xx1C312, xx1C323, xx1C325, xx1C405, xx1C408, xx1C425, xx1C428,  
460 xx1C430, xx1C431, xx1HC28, xx1HC29, xx1HC30, xx1HC32, xx1R1, xx1R29,  
461 xx1SC406, xx1SC408, xx2HC28, xx2HC29, xx2HC30, xx2R1, xx2R29, xx2SC406,  
462 xx2SC408, xx3C302, xx3C308, xx3C310, xx3C311, xx3C312, xx3C323, xx3C325,  
463 xx3C405, xx3C408, xx3C425, xx3C428, xx3C430, xx3C431, xx3C432, xx3HC28,  
\_Economic Optimization Program

464 xx3HC29, xx3HC30, xx3HC32, xx3R1, xx3R29, xx3SC406, xx3SC408, xx4C302,  
465 xx4C308, xx4C310, xx4C311, xx4C312, xx4C323, xx4C325, xx4C405, xx4C408,  
466 xx4C409, xx4C425, xx4C427, xx4C428, xx4C430, xx4C431, xx4C432, xx4HC28,  
467 xx4HC29, xx4HC30, xx4HC32, xx4R1, xx4R29, xx4SC406, xx4SC408, xx5C302,  
468 xx5C308, xx5C310, xx5C311, xx5C312, xx5C323, xx5C325, xx5C405, xx5C408,  
469 xx5C425, xx5C428, xx5C430, xx5C431, xx5HC28, xx5HC29, xx5HC30, xx5HC32,  
470 xx5R1, xx5R29, xx5SC406, xx5SC408, xx6SC406, xx6SC408, xx7C302, xx7C308,  
471 xx7C310, xx7C311, xx7C312, xx7C323, xx7C325, xx7C405, xx7C408, xx7C425,  
472 xx7C428, xx7C430, xx7C431, xx7HC28, xx7HC29, xx7HC30, xx7HC32, xx7R1,  
473 xx7R29, xx7SC406, xx7SC408, y1HC28, y1HC29, y1HC30, y1HC31, y1R1,  
474 y1R29, y2HC28, y2HC29, y2HC30, y2HC31, y2R1, y2R29, y3HC28,  
475 y3HC29, y3HC30, y3HC31, y3R1, y3R29, y4HC28, y4HC29, y4HC30,  
476 y4HC31, y4R1, y4R29, y5HC28, y5HC29, y5HC30, y5HC31, y5R1,  
477 y5R29, y7HC28, y7HC29, y7HC30, y7HC31, y7R1, y7R29, yy1HC28,  
478 yy1HC29, yy1HC30, yy1R1, yy1R29, yy2HC28, yy2HC29, yy2HC30, yy2R1,  
479 yy2R29, yy3HC28, yy3HC29, yy3HC30, yy3R1, yy3R29, yy4HC28, yy4HC29,  
480 yy4HC30, yy4R1, yy4R29, yy5HC28, yy5HC29, yy5HC30, yy5R1, yy5R29,  
481 yy7HC28, yy7HC29, yy7HC30, yy7R1, yy7R29;  
482  
483 \* The following are the Parameters in the Model  
484 SCALARS  
485 deltaPE634 / 70 /  
486 deltaPE640 / 20 /  
487 FE601 / 0.5 /  
488 FE603 / 1 /  
489 FE609A / 0.5 /  
490 FE610 / 0.93398 /  
491 FE611 / 0.52182 /  
492 FE616 / 0.5 /  
493 FE617 / 1 /  
494 FE621A / 0.73974 /  
495 FE621B / 1 /  
496 FE626 / 0.5 /  
497 FE627A / 0.50163 /  
498 FE627B / 0.52572 /  
499 FE628 / 0.5 /  
500 FE629 / 0.5 /  
501 FE634 / 1 /  
502 FE640 / 0.75692 /  
503 FE641 / 0.5 /

504 hstmE602 / 2145 /  
 505 hstmE612 / 2145 /  
 506 hstmE695 / 1920 /  
 507 hstmE696 / 2145 /  
 508 PC606A / 900 /  
 509 PC606C / 890 /  
 \_Economic Optimization Program

05/15/01 16:49:39 PAGE 12  
 GAMS 2.50A Windows NT/95/98

510 PC606D / 900 /  
 511 PE633 / 145 /  
 512 qC601 / 1 /  
 513 qC603 / 0.99037 /  
 514 qC606A / 0.5 /  
 515 RC601 / 9.22101 /  
 516 RC603 / 14 /  
 517 sfC631 / 0.97742 /  
 518 sfC632 / 0.9815 /  
 519 sfC633 / 0.99131 /  
 520 sfC634 / 0.98926 /  
 521 Tcwin / 290 /  
 522 UE601 / 0.008 /  
 523 UE602 / 0.01596 /  
 524 UE603 / 0.02513 /  
 525 UE605 / 0.04982 /  
 526 UE609A / 0.04 /  
 527 UE610 / 0.08981 /  
 528 UE611 / 0.1 /  
 529 UE612 / 0.013 /  
 530 UE613 / 0.02563 /  
 531 UE616 / 0.01 /  
 532 UE617 / 0.05255 /  
 533 UE621A / 0.114 /  
 534 UE621B / 0.07589 /  
 535 UE626 / 0.01 /  
 536 UE627A / 0.01 /  
 537 UE627B / 0.01 /  
 538 UE628 / 0.01435 /  
 539 UE629 / 0.01 /  
 540 UE633 / 0.0177 /  
 541 UE634 / 0.02059 /  
 542 UE640 / 0.01 /  
 543 UE641 / 0.08735 /  
 544 UE695A / 0.03291 /  
 545 UE695B / 0.03883 /  
 546 UE696A / 0.01216 /  
 547 UE696B / 0.01 /  
 548 UE6XX / 0.02855 /  
 549 ;  
 550

551 VARIABLES  
 552 ObjVar Objective function using ' ' algorithm;  
 553  
 554 SETS  
 555 Coeff /a1,a2,a3,a4,a5/  
 \_Economic Optimization Program

05/15/01 16:49:39 PAGE 13  
 GAMS 2.50A Windows NT/95/98

556 Comp /1, 2, 3, 4, 5, 6, 7, 8, 9, 10/  
 557 ;  
 558 TABLE Enth\_Coe(Comp,Coeff)  
 559       a1       a2       a3       a4  
 560 1       4.211     1.716e-03   7.062e-05   -9.196e-08  
 561 2       4.4267    6.6394e-03   6.8065e-05   -9.2875e-08  
 562 3       4.455     8.261e-03    8.299e-05    -1.146e-07  
 563 4       6.147     1.559e-04    9.679e-05    -1.255e-07  
 564 5       1.083     4.457e-02    8.239e-06    -3.526e-08  
 565 6       1.898     4.12e-02     1.231e-05    -3.659e-08  
 566 7       8.763     2.162e-03    1.317e-04    -1.738e-07  
 567 8       1.115e01    -9.494e-03    1.956e-04    -2.498e-07  
 568 9       8.157e-01    7.326e-02    1.783e-05    -6.936e-08  
 569 10       2.876     7.579e-02    1.346e-05    -6.409e-08  
 570 +  
 571 1       a5  
 571 1       3.644e-11  
 572 2       3.7347e-11  
 573 3       4.646e-11  
 574 4       4.978e-11  
 575 5       1.579e-11  
 576 6       1.504e-11  
 577 7       6.925e-11  
 578 8       9.489e-11  
 579 9       3.216e-11  
 580 10       2.869e-11  
 581 TABLE Enth\_Form(Comp,Coeff)  
 582       a1       a2       a3  
 583 1       -80.697     -9.05e-02    4.2104e-05  
 584 2       21.822     -8.5458e-02   3.8902e-05  
 585 3       -106.746    -1.0929e-01   5.2693e-05  
 586 4       -98.186     -1.0974e-01   5.2254e-05  
 587 5       -121.118    -1.3184e-01   6.5174e-05

```

588 6      -113.399    -1.3001e-01    6.2902e-05
589 7      -137.114    -1.4707e-01    7.2785e-05
590 8      -151.825    -1.7028e-01    8.4061e-05
591 9      -167.368    -1.9025e-01    9.4496e-05
592 10     -184.627     -2.0407e-01    1.0198e-04
593 TABLE Enth_gas(Comp,Coeff)
594      a1      a2      a3      a4
595 1      28.277      1.16e-01    1.9597e-04    -2.3271e-07
596 2      30.11      1.71e-01    1.01e-04    -1.812e-07
597 3      6.772      3.4147e-01    -1.0271e-04    -3.685e-08
598 4      20.056     2.815e-01    -1.314e-05    -9.4571e-08
599 5      -0.881      4.75e-01    -2.479e-04    6.751e-08
600 6      26.671     3.234e-01    4.282e-05    -1.664e-07
601 7      -7.197      6.009e-01    -3.409e-04    9.521e-08

```

\_Economic Optimization Program

```

602 8      -3.249      6.663e-01    -3.383e-04    6.0489e-08
603 9      -3.367      7.5824e-01    -3.8216e-04    5.736e-08
604 10     51.299     5.356e-01    1.696e-04    -4.023e-07
605 +      a5
606 1      6.867e-11
607 2      5.732e-11
608 3      2.043e-11
609 4      3.415e-11
610 5      -8.534e-12
611 6      5.604e-11
612 7      -1.029e-11
613 8      2.5385e-12
614 9      8.0178e-12
615 10     1.3567e-10

```

616 TABLE Enth\_liq(Comp,Coeff)

```

617      a1      a2      a3      a4
618 1      59.642     3.283e-1    -1.5377e-03    3.6539e-06
619 2      50      5.1e-01    -2.02e-03    2.56e-06
620 3      71.791     4.8472e-01    -2.0519e-03    4.0634e-06
621 4      62.873     5.8913e-01    -2.3558e-03    4.2257e-06
622 5      91.474     4.4852e-01    -1.6859e-03    3.1342e-06
623 6      80.641     6.2195e-01    -2.2682e-03    3.7423e-06
624 7      110.129    5.0521e-01    -1.7675e-03    3.066e-06
625 8      118.184    7.1284e-01    -2.3129e-03    3.4493e-06
626 9      134.965    8.1458e-01    -2.5182e-03    3.5416e-06
627 10     129.481    1.1045     -3.2083e-03    4.0849e-06

```

628 TABLE Enth\_Vap(Comp,Coeff)

```

629      a1      a2      a3
630 1      26.89      369.82     0.365
631 2      33.39      419.59     0.393
632 3      31.954     408.14     0.392
633 4      33.02      425.18     0.377
634 5      37.692     460.43     0.395
635 6      39.854     469.65     0.398
636 7      42.78      497.5      0.384
637 8      49.917     530.37     0.408
638 9      59.503     559.64     0.481
639 10     59.521     586.75     0.397

```

640  
641 EQUATIONS

642 \* The Constraints

```

643 EQU1, EQU2, EQU3, EQU4, EQU5, EQU6,
644 EQU7, EQU8, EQU9, EQU10, EQU11, EQU12,
645 EQU13, EQU14, EQU15, EQU16, EQU17, EQU18,
646 EQU19, EQU20, EQU21, EQU22, EQU23, EQU24,
647 EQU25, EQU26, EQU27, EQU28, EQU29, EQU30,

```

\_Economic Optimization Program

```

648 EQU31, EQU32, EQU33, EQU34, EQU35, EQU36,
649 EQU37, EQU38, EQU39, EQU40, EQU41, EQU42,
650 EQU43, EQU44, EQU45, EQU46, EQU47, EQU48,
651 EQU49, EQU50, EQU51, EQU52, EQU53, EQU54,
652 EQU55, EQU56, EQU57, EQU58, EQU59, EQU60,
653 EQU61, EQU62, EQU63, EQU64, EQU65, EQU66,
654 EQU67, EQU68, EQU69, EQU70, EQU71, EQU72,
655 EQU73, EQU74, EQU75, EQU76, EQU77, EQU78,
656 EQU79, EQU80, EQU81, EQU82, EQU83, EQU84,
657 EQU85, EQU86, EQU87, EQU88, EQU89, EQU90,
658 EQU91, EQU92, EQU93, EQU94, EQU95, EQU96,
659 EQU97, EQU98, EQU99, EQU100, EQU101, EQU102,
660 EQU103, EQU104, EQU105, EQU106, EQU107, EQU108,
661 EQU109, EQU110, EQU111, EQU112, EQU113, EQU114,
662 EQU115, EQU116, EQU117, EQU118, EQU119, EQU120,
663 EQU121, EQU122, EQU123, EQU124, EQU125, EQU126,
664 EQU127, EQU128, EQU129, EQU130, EQU131, EQU132,
665 EQU133, EQU134, EQU135, EQU136, EQU137, EQU138,
666 EQU139, EQU140, EQU141, EQU142, EQU143, EQU144,
667 EQU145, EQU146, EQU147, EQU148, EQU149, EQU150,
668 EQU151, EQU152, EQU153, EQU154, EQU155, EQU156,
669 EQU157, EQU158, EQU159, EQU160, EQU161, EQU162,
670 EQU163, EQU164, EQU165, EQU166, EQU167, EQU168,
671 EQU169, EQU170, EQU171, EQU172, EQU173, EQU174,

```

672 EQU175, EQU176, EQU177, EQU178, EQU179, EQU180,  
673 EQU181, EQU182, EQU183, EQU184, EQU185, EQU186,  
674 EQU187, EQU188, EQU189, EQU190, EQU191, EQU192,  
675 EQU193, EQU194, EQU195, EQU196, EQU197, EQU198,  
676 EQU199, EQU200, EQU201, EQU202, EQU203, EQU204,  
677 EQU205, EQU206, EQU207, EQU208, EQU209, EQU210,  
678 EQU211, EQU212, EQU213, EQU214, EQU215, EQU216,  
679 EQU217, EQU218, EQU219, EQU220, EQU221, EQU222,  
680 EQU223, EQU224, EQU225, EQU226, EQU227, EQU228,  
681 EQU229, EQU230, EQU231, EQU232, EQU233, EQU234,  
682 EQU235, EQU236, EQU237, EQU238, EQU239, EQU240,  
683 EQU241, EQU242, EQU243, EQU244, EQU245, EQU246,  
684 EQU247, EQU248, EQU249, EQU250, EQU251, EQU252,  
685 EQU253, EQU254, EQU255, EQU256, EQU257, EQU258,  
686 EQU259, EQU260, EQU261, EQU262, EQU263, EQU264,  
687 EQU265, EQU266, EQU267, EQU268, EQU269, EQU270,  
688 EQU271, EQU272, EQU273, EQU274, EQU275, EQU276,  
689 EQU277, EQU278, EQU279, EQU280, EQU281, EQU282,  
690 EQU283, EQU284, EQU285, EQU286, EQU287, EQU288,  
691 EQU289, EQU290, EQU291, EQU292, EQU293, EQU294,  
692 EQU295, EQU296, EQU297, EQU298, EQU299, EQU300,  
693 EQU301, EQU302, EQU303, EQU304, EQU305, EQU306,  
\_Economic Optimization Program

05/15/01 16:49:39 PAGE 16  
GAMS 2.50A Windows NT/95/98

694 EQU307, EQU308, EQU309, EQU310, EQU311, EQU312,  
695 EQU313, EQU314, EQU315, EQU316, EQU317, EQU318,  
696 EQU319, EQU320, EQU321, EQU322, EQU323, EQU324,  
697 EQU325, EQU326, EQU327, EQU328, EQU329, EQU330,  
698 EQU331, EQU332, EQU333, EQU334, EQU335, EQU336,  
699 EQU337, EQU338, EQU339, EQU340, EQU341, EQU342,  
700 EQU343, EQU344, EQU345, EQU346, EQU347, EQU348,  
701 EQU349, EQU350, EQU351, EQU352, EQU353, EQU354,  
702 EQU355, EQU356, EQU357, EQU358, EQU359, EQU360,  
703 EQU361, EQU362, EQU363, EQU364, EQU365, EQU366,  
704 EQU367, EQU368, EQU369, EQU370, EQU371, EQU372,  
705 EQU373, EQU374, EQU375, EQU376, EQU377, EQU378,  
706 EQU379, EQU380, EQU381, EQU382, EQU383, EQU384,  
707 EQU385, EQU386, EQU387, EQU388, EQU389, EQU390,  
708 EQU391, EQU392, EQU393, EQU394, EQU395, EQU396,  
709 EQU397, EQU398, EQU399, EQU400, EQU401, EQU402,  
710 EQU403, EQU404, EQU405, EQU406, EQU407, EQU408,  
711 EQU409, EQU410, EQU411, EQU412, EQU413, EQU414,  
712 EQU415, EQU416, EQU417, EQU418, EQU419, EQU420,  
713 EQU421, EQU422, EQU423, EQU424, EQU425, EQU426,  
714 EQU427, EQU428, EQU429, EQU430, EQU431, EQU432,  
715 EQU433, EQU434, EQU435, EQU436, EQU437, EQU438,  
716 EQU439, EQU440, EQU441, EQU442, EQU443, EQU444,  
717 EQU445, EQU446, EQU447, EQU448, EQU449, EQU450,  
718 EQU451, EQU452, EQU453, EQU454, EQU455, EQU456,  
719 EQU457, EQU458, EQU459, EQU460, EQU461, EQU462,  
720 EQU463, EQU464, EQU465, EQU466, EQU467, EQU468,  
721 EQU469, EQU470, EQU471, EQU472, EQU473, EQU474,  
722 EQU475, EQU476, EQU477, EQU478, EQU479, EQU480,  
723 EQU481, EQU482, EQU483, EQU484, EQU485, EQU486,  
724 EQU487, EQU488, EQU489, EQU490, EQU491, EQU492,  
725 EQU493, EQU494, EQU495, EQU496, EQU497, EQU498,  
726 EQU499, EQU500, EQU501, EQU502, EQU503, EQU504,  
727 EQU505, EQU506, EQU507, EQU508, EQU509, EQU510,  
728 EQU511, EQU512, EQU513, EQU514, EQU515, EQU516,  
729 EQU517, EQU518, EQU519, EQU520, EQU521, EQU522,  
730 EQU523, EQU524, EQU525, EQU526, EQU527, EQU528,  
731 EQU529, EQU530, EQU531, EQU532, EQU533, EQU534,  
732 EQU535, EQU536, EQU537, EQU538, EQU539, EQU540,  
733 EQU541, EQU542, EQU543, EQU544, EQU545, EQU546,  
734 EQU547, EQU548, EQU549, EQU550, EQU551, EQU552,  
735 EQU553, EQU554, EQU555, EQU556, EQU557, EQU558,  
736 EQU559, EQU560, EQU561, EQU562, EQU563, EQU564,  
737 EQU565, EQU566, EQU567, EQU568, EQU569, EQU570,  
738 EQU571, EQU572, EQU573, EQU574, EQU575, EQU576,  
739 EQU577, EQU578, EQU579, EQU580, EQU581, EQU582,  
\_Economic Optimization Program

05/15/01 16:49:39 PAGE 17  
GAMS 2.50A Windows NT/95/98

740 EQU583, EQU584, EQU585, EQU586, EQU587, EQU588,  
741 EQU589, EQU590, EQU591, EQU592, EQU593, EQU594,  
742 EQU595, EQU596, EQU597, EQU598, EQU599, EQU600,  
743 EQU601, EQU602, EQU603, EQU604, EQU605, EQU606,  
744 EQU607, EQU608, EQU609, EQU610, EQU611, EQU612,  
745 EQU613, EQU614, EQU615, EQU616, EQU617, EQU618,  
746 EQU619, EQU620, EQU621, EQU622, EQU623, EQU624,  
747 EQU625, EQU626, EQU627, EQU628, EQU629, EQU630,  
748 EQU631, EQU632, EQU633, EQU634, EQU635, EQU636,  
749 EQU637, EQU638, EQU639, EQU640, EQU641, EQU642,  
750 EQU643, EQU644, EQU645, EQU646, EQU647, EQU648,  
751 EQU649, EQU650, EQU651, EQU652, EQU653, EQU654,  
752 EQU655, EQU656, EQU657, EQU658, EQU659, EQU660,  
753 EQU661, EQU662, EQU663, EQU664, EQU665, EQU666,  
754 EQU667, EQU668, EQU669, EQU670, EQU671, EQU672,  
755 EQU673, EQU674, EQU675, EQU676, EQU677, EQU678,

756 EQU679, EQU680, EQU681, EQU682, EQU683, EQU684,  
757 EQU685, EQU686, EQU687, EQU688, EQU689, EQU690,  
758 EQU691, EQU692, EQU693, EQU694, EQU695, EQU696,  
759 EQU697, EQU698, EQU699, EQU700, EQU701, EQU702,  
760 EQU703, EQU704, EQU705, EQU706, EQU707, EQU708,  
761 EQU709, EQU710, EQU711, EQU712, EQU713, EQU714,  
762 EQU715, EQU716, EQU717, EQU718, EQU719, EQU720,  
763 EQU721, EQU722, EQU723, EQU724, EQU725, EQU726,  
764 EQU727, EQU728, EQU729, EQU730, EQU731, EQU732,  
765 EQU733, EQU734, EQU735, EQU736, EQU737, EQU738,  
766 EQU739, EQU740, EQU741, EQU742, EQU743, EQU744,  
767 EQU745, EQU746, EQU747, EQU748, EQU749, EQU750,  
768 EQU751, EQU752, EQU753, EQU754, EQU755, EQU756,  
769 EQU757, EQU758, EQU759, EQU760, EQU761, EQU762,  
770 EQU763, EQU764, EQU765, EQU766, EQU767, EQU768,  
771 EQU769, EQU770, EQU771, EQU772, EQU773, EQU774,  
772 EQU775, EQU776, EQU777, EQU778, EQU779, EQU780,  
773 EQU781, EQU782, EQU783, EQU784, EQU785, EQU786,  
774 EQU787, EQU788, EQU789, EQU790, EQU791, EQU792,  
775 EQU793, EQU794, EQU795, EQU796, EQU797, EQU798,  
776 EQU799, EQU800, EQU801, EQU802, EQU803, EQU804,  
777 EQU805, EQU806, EQU807, EQU808, EQU809, EQU810,  
778 EQU811, EQU812, EQU813, EQU814, EQU815, EQU816,  
779 EQU817, EQU818, EQU819, EQU820, EQU821, EQU822,  
780 EQU823, EQU824, EQU825, EQU826, EQU827, EQU828,  
781 EQU829, EQU830, EQU831, EQU832, EQU833, EQU834,  
782 EQU835, EQU836, EQU837, EQU838, EQU839, EQU840,  
783 EQU841, EQU842, EQU843, EQU844, EQU845, EQU846,  
784 EQU847, EQU848, EQU849, EQU850, EQU851, EQU852,  
785 EQU853, EQU854, EQU855, EQU856, EQU857, EQU858,  
\_Economic Optimization Program

05/15/01 16:49:39 PAGE 18  
GAMS 2.50A Windows NT/95/98

786 EQU859, EQU860, EQU861, EQU862, EQU863, EQU864,  
787 EQU865, EQU866, EQU867, EQU868, EQU869, EQU870,  
788 EQU871, EQU872, EQU873, EQU874, EQU875, EQU876,  
789 EQU877, EQU878, EQU879, EQU880, EQU881, EQU882,  
790 EQU883, EQU884, EQU885, EQU886, EQU887, EQU888,  
791 EQU889, EQU890, EQU891, EQU892, EQU893, EQU894,  
792 EQU895, EQU896, EQU897, EQU898, EQU899, EQU900,  
793 EQU901, EQU902, EQU903, EQU904, EQU905, EQU906,  
794 EQU907, EQU908, EQU909, EQU910, EQU911, EQU912,  
795 EQU913, EQU914, EQU915, EQU916, EQU917, EQU918,  
796 EQU919, EQU920, EQU921, EQU922, EQU923, EQU924,  
797 EQU925, EQU926, EQU927, EQU928, EQU929, EQU930,  
798 EQU931, EQU932, EQU933, EQU934, EQU935, EQU936,  
799 EQU937, EQU938, EQU939, EQU940, EQU941, EQU942,  
800 EQU943, EQU944, EQU945, EQU946, EQU947, EQU948,  
801 EQU949, EQU950, EQU951, EQU952, EQU953, EQU954,  
802 EQU955, EQU956, EQU957, EQU958, EQU959, EQU960,  
803 EQU961, EQU962, EQU963, EQU964, EQU965, EQU966,  
804 EQU967, EQU968, EQU969, EQU970, EQU971, EQU972,  
805 EQU973, EQU974, EQU975, EQU976, EQU977, EQU978,  
806 EQU979, EQU980, EQU981, EQU982, EQU983, EQU984,  
807 EQU985, EQU986, EQU987, EQU988, EQU989, EQU990,  
808 EQU991, EQU992, EQU993, EQU994, EQU995, EQU996,  
809 EQU997, EQU998, EQU999, EQU1000, EQU1001, EQU1002,  
810 EQU1003, EQU1004, EQU1005, EQU1006, EQU1007, EQU1008,  
811 EQU1009, EQU1010, EQU1011, EQU1012, EQU1013, EQU1014,  
812 EQU1015, EQU1016, EQU1017, EQU1018, EQU1019, EQU1020,  
813 EQU1021, EQU1022, EQU1023, EQU1024, EQU1025, EQU1026,  
814 EQU1027, EQU1028, EQU1029, EQU1030, EQU1031, EQU1032,  
815 EQU1033, EQU1034, EQU1035, EQU1036, EQU1037, EQU1038,  
816 EQU1039, EQU1040, EQU1041, EQU1042, EQU1043, EQU1044,  
817 EQU1045, EQU1046, EQU1047, EQU1048, EQU1049, EQU1050,  
818 EQU1051, EQU1052, EQU1053, EQU1054, EQU1055, EQU1056,  
819 EQU1057, EQU1058, EQU1059, EQU1060, EQU1061, EQU1062,  
820 EQU1063, EQU1064, EQU1065, EQU1066, EQU1067, EQU1068,  
821 EQU1069, EQU1070, EQU1071, EQU1072, EQU1073, EQU1074,  
822 EQU1075, EQU1076, EQU1077, EQU1078, EQU1079, EQU1080,  
823 EQU1081, EQU1082, EQU1083, EQU1084, EQU1085, EQU1086,  
824 EQU1087, EQU1088, EQU1089, EQU1090, EQU1091, EQU1092,  
825 EQU1093, EQU1094, EQU1095, EQU1096, EQU1097, EQU1098,  
826 EQU1099, EQU1100, EQU1101, EQU1102, EQU1103, EQU1104,  
827 EQU1105, EQU1106, EQU1107, EQU1108, EQU1109, EQU1110,  
828 EQU1111, EQU1112, EQU1113, EQU1114, EQU1115, EQU1116,  
829 EQU1117, EQU1118, EQU1119, EQU1120, EQU1121, EQU1122,  
830 EQU1123, EQU1124, EQU1125, EQU1126, EQU1127, EQU1128,  
831 EQU1129, EQU1130, EQU1131, EQU1132, EQU1133, EQU1134,  
\_Economic Optimization Program

05/15/01 16:49:39 PAGE 19  
GAMS 2.50A Windows NT/95/98

832 EQU1135, EQU1136, EQU1137, EQU1138, EQU1139, EQU1140,  
833 EQU1141, EQU1142, EQU1143, EQU1144, EQU1145, EQU1146,  
834 EQU1147, EQU1148, EQU1149, EQU1150, EQU1151, EQU1152,  
835 EQU1153, EQU1154, EQU1155, EQU1156, EQU1157, EQU1158,  
836 EQU1159, EQU1160, EQU1161, EQU1162, EQU1163, EQU1164,  
837 EQU1165, EQU1166, EQU1167, EQU1168, EQU1169, EQU1170,  
838 EQU1171, EQU1172, EQU1173, EQU1174, EQU1175, EQU1176,  
839 EQU1177, EQU1178, EQU1179, EQU1180, EQU1181, EQU1182,

840 EQU1183, EQU1184, EQU1185, EQU1186, EQU1187, EQU1188,  
841 EQU1189, EQU1190, EQU1191, EQU1192, EQU1193, EQU1194,  
842 EQU1195, EQU1196, EQU1197, EQU1198, EQU1199, EQU1200,  
843 EQU1201, EQU1202, EQU1203, EQU1204, EQU1205, EQU1206,  
844 EQU1207, EQU1208, EQU1209, EQU1210, EQU1211, EQU1212,  
845 EQU1213, EQU1214, EQU1215, EQU1216, EQU1217, EQU1218,  
846 EQU1219, EQU1220, EQU1221, EQU1222, EQU1223, EQU1224,  
847 EQU1225, EQU1226, EQU1227, EQU1228, EQU1229, EQU1230,  
848 EQU1231, EQU1232, EQU1233, EQU1234, EQU1235, EQU1236,  
849 EQU1237, EQU1238, EQU1239, EQU1240, EQU1241, EQU1242,  
850 EQU1243, EQU1244, EQU1245, EQU1246, EQU1247, EQU1248,  
851 EQU1249, EQU1250, EQU1251, EQU1252, EQU1253, EQU1254,  
852 EQU1255, EQU1256, EQU1257, EQU1258, EQU1259, EQU1260,  
853 EQU1261, EQU1262, EQU1263, EQU1264, EQU1265, EQU1266,  
854 EQU1267, EQU1268, EQU1269, EQU1270, EQU1271, EQU1272,  
855 EQU1273, EQU1274, EQU1275, EQU1276, EQU1277, EQU1278,  
856 EQU1279, EQU1280, EQU1281, EQU1282, EQU1283, EQU1284,  
857 EQU1285, EQU1286, EQU1287, EQU1288, EQU1289, EQU1290,  
858 EQU1291, EQU1292, EQU1293, EQU1294, EQU1295, EQU1296,  
859 EQU1297, EQU1298, EQU1299, EQU1300, EQU1301, EQU1302,  
860 EQU1303, EQU1304, EQU1305, EQU1306, EQU1307, EQU1308,  
861 EQU1309, EQU1310, EQU1311, EQU1312, EQU1313, EQU1314,  
862 EQU1315, EQU1316, EQU1317, EQU1318, EQU1319, EQU1320,  
863 EQU1321, EQU1322, EQU1323, EQU1324, EQU1325, EQU1326,  
864 EQU1327, EQU1328, EQU1329, EQU1330, EQU1331, EQU1332,  
865 EQU1333, EQU1334, EQU1335, EQU1336, EQU1337, EQU1338,  
866 EQU1339, EQU1340, EQU1341, EQU1342, EQU1343, EQU1344,  
867 EQU1345, EQU1346, EQU1347, EQU1348, EQU1349, EQU1350,  
868 EQU1351, EQU1352, EQU1353, EQU1354, EQU1355, EQU1356,  
869 EQU1357, EQU1358, EQU1359, EQU1360, EQU1361, EQU1362,  
870 EQU1363, EQU1364, EQU1365, EQU1366, EQU1367, EQU1368,  
871 EQU1369, EQU1370, EQU1371, EQU1372, EQU1373, EQU1374,  
872 EQU1375, EQU1376, EQU1377, EQU1378, EQU1379, EQU1380,  
873 EQU1381, EQU1382, EQU1383, EQU1384, EQU1385, EQU1386,  
874 EQU1387, EQU1388, EQU1389, EQU1390, EQU1391, EQU1392,  
875 EQU1393, EQU1394, EQU1395, EQU1396, EQU1397, EQU1398,  
876 EQU1399, EQU1400, EQU1401, EQU1402, EQU1403, EQU1404,  
877 EQU1405, EQU1406, EQU1407, EQU1408, EQU1409, EQU1410,  
\_Economic Optimization Program

05/15/01 16:49:39 PAGE 20  
GAMS 2.50A Windows NT/95/98

878 EQU1411, EQU1412, EQU1413, EQU1414, EQU1415, EQU1416,  
879 EQU1417, EQU1418, EQU1419, EQU1420, EQU1421, EQU1422,  
880 EQU1423, EQU1424, EQU1425, EQU1426, EQU1427, EQU1428,  
881 EQU1429, EQU1430, EQU1431, EQU1432, EQU1433, EQU1434,  
882 EQU1435, EQU1436, EQU1437, EQU1438, EQU1439, EQU1440,  
883 EQU1441, EQU1442, EQU1443, EQU1444, EQU1445, EQU1446,  
884 EQU1447, EQU1448, EQU1449, EQU1450, EQU1451, EQU1452,  
885 EQU1453, EQU1454, EQU1455, EQU1456, EQU1457, EQU1458,  
886 EQU1459, EQU1460, EQU1461, EQU1462, EQU1463, EQU1464,  
887 EQU1465, EQU1466, EQU1467, EQU1468, EQU1469, EQU1470,  
888 EQU1471, EQU1472, EQU1473, EQU1474, EQU1475, EQU1476,  
889 EQU1477, EQU1478, EQU1479, EQU1480, EQU1481, EQU1482,  
890 EQU1483, EQU1484, EQU1485, EQU1486, EQU1487, EQU1488,  
891 EQU1489, EQU1490, EQU1491, EQU1492, EQU1493, EQU1494,  
892 EQU1495, EQU1496, EQU1497, EQU1498, EQU1499, EQU1500,  
893 EQU1501, EQU1502, EQU1503, EQU1504, EQU1505, EQU1506,  
894 EQU1507, EQU1508, EQU1509, EQU1510, EQU1511, EQU1512,  
895 EQU1513, EQU1514, EQU1515, EQU1516, EQU1517, EQU1518,  
896 EQU1519, EQU1520, EQU1521, EQU1522, EQU1523, EQU1524,  
897 EQU1525, EQU1526, EQU1527, EQU1528, EQU1529, EQU1530,  
898 EQU1531, EQU1532, EQU1533, EQU1534, EQU1535, EQU1536,  
899 EQU1537, EQU1538, EQU1539, EQU1540, EQU1541, EQU1542,  
900 EQU1543, EQU1544, EQU1545, EQU1546, EQU1547, EQU1548,  
901 EQU1549, EQU1550, EQU1551, EQU1552, EQU1553, EQU1554,  
902 EQU1555, EQU1556, EQU1557, EQU1558, EQU1559, EQU1560,  
903 EQU1561, EQU1562, EQU1563, EQU1564, EQU1565, EQU1566,  
904 EQU1567, EQU1568, EQU1569, EQU1570, EQU1571, EQU1572,  
905 EQU1573, EQU1574, EQU1575, EQU1576, EQU1577, EQU1578,  
906 EQU1579,  
907 INEQU1, INEQU2, INEQU3, INEQU4, INEQU5, INEQU6,  
908 INEQU7, INEQU8, INEQU9, INEQU10, INEQU11, INEQU12,  
909 INEQU13, INEQU14, INEQU15, INEQU16, INEQU17, INEQU18,  
910 INEQU19, INEQU20, INEQU21, INEQU22, INEQU23, INEQU24,  
911 INEQU25, INEQU26, INEQU27, INEQU28, INEQU29, INEQU30,  
912 INEQU31, INEQU32, INEQU33, INEQU34, INEQU35, INEQU36,  
913 INEQU37, INEQU38, INEQU39, INEQU40, INEQU41, INEQU42,  
914 INEQU43, INEQU44, INEQU45, INEQU46, INEQU47, INEQU48,  
915 INEQU49, INEQU50, ObjName;  
916  
917 ObjName..ObjVar=E=  
918 Profit;  
919  
920 EQU1..x7C308 - x7C309 =e= 0;  
921 EQU2..x3C308 - x3C309 =e= 0;  
922 EQU3..TC317 - TC323 =e= 0;  
923 EQU4..RC603\*FC328 - FC329 =e= 0;  
\_Economic Optimization Program

05/15/01 16:49:39 PAGE 21  
GAMS 2.50A Windows NT/95/98



924 EQU5..FC323 - FC324 =e= 0;  
 925 EQU6..x1C323 - x1C324 =e= 0;  
 926 EQU7..x3C323 - x3C324 =e= 0;  
 927 EQU8..x4C323 - x4C324 =e= 0;  
 928 EQU9..x5C323 - x5C324 =e= 0;  
 929 EQU10..hHC03 - FHC03 \* ((x1HC03/MW1)\*(SUM(Coeff,1/ORD(Coeff)\* Enth\_liq("1",Coeff) \*POWER(THC03,ORD(Coeff))))  
 930 +(x2HC03/MW2)\*(SUM(Coeff,1/ORD(Coeff)\* Enth\_liq("2",Coeff) \* POWER(THC03,ORD(Coeff))))  
 931 +(x3HC03/MW3)\*(SUM(Coeff,1/ORD(Coeff)\* Enth\_liq("3",Coeff) \* POWER(THC03,ORD(Coeff))))  
 932 +(x4HC03/MW4)\*(SUM(Coeff,1/ORD(Coeff)\* Enth\_liq("4",Coeff) \*POWER(THC03,ORD(Coeff))))  
 933 +(x5HC03/MW5)\*(SUM(Coeff,1/ORD(Coeff)\* Enth\_liq("5",Coeff) \*POWER(THC03,ORD(Coeff))))  
 934 +(x7HC03/MW7)\*(SUM(Coeff,1/ORD(Coeff)\* Enth\_liq("7",Coeff) \*POWER(THC03,ORD(Coeff)))) =e= 0;  
 935 EQU11..x1HC03 + x2HC03 + x3HC03 + x4HC03 + x5HC03 + x7HC03 =e= 1;  
 936 EQU12..FC319 \* sf2S34 - FC321 =e= 0;  
 937 EQU13..x7C306 - x7C307 =e= 0;  
 938 EQU14..kWad1+kWad2 =e= WK601;  
 939 EQU15..TmK601 \*FC306 =e= FC303\*(PC310/PC303)\*\*((kK601-1)/kK601) + FC310\*TC310;  
 940 EQU16..TC306 =e= TmK601\*(PC306/PC310)\*\*((kK601-1)/kK601);  
 941 EQU17..x3C306 - x3C307 =e= 0;  
 942 EQU18..PC307=e=PC306-deltaPE634;  
 943 EQU19..dTE634\*\*3 =e= ((TC306-TcwinoutE634)\*(TC307-Tcwin)  
 944 ((TC306-TcwinoutE634)+(TC307-Tcwin))/2);  
 945 EQU20..xx1C312 + xx3C312 + xx4C312 + xx5C312 + xx7C312 =e= 1;  
 946 EQU21..K3C615\_A \* xx3C308 - xx3C312 =e= 0;  
 947 EQU22..FC312 =e= VFC615\*FC307;  
 948 EQU23..(hC308 - hC309) - UE640\*AE640\*FE640\*dTE640 =e= 0;  
 949 EQU24..x4C308 - x4C309 =e= 0;  
 950 EQU25..x5C308 - x5C309 =e= 0;  
 951 EQU26..TC310 - TC311 =e= 0;  
 952 EQU27..K4C616\_A=e=0.13332\*EXP(15.6782-2154.90/(TC310-34.42))/PC310;  
 953 EQU28..PC310 -PC311 =e= 0;  
 954 EQU29..K5C616\_A=e=0.13332\*EXP(15.5338-2348.67/(TC310-40.05))/PC310;  
 955 EQU30..K7C616\_A=e=0.13332\*EXP(15.7588-2633.90/(TC310-46.30))/PC310;  
 956 EQU31..PC307 - PC312 =e= 0;  
 957 EQU32..PC307 - PC308 =e= 0;  
 958 EQU33..x7C317 - x7C323 =e= 0;  
 959 EQU34..LpC603=e=FC329 + qC603\*FC316;  
 960 EQU35..VpC603=e=LpC603 - FC317;  
 961 EQU36..TnC603=e=(TC325+TC316)/2;  
 962 EQU37..x1C326 - x1C329 =e= 0;  
 963 EQU38..x3C326 - x3C329 =e= 0;  
 964 EQU39..x4C326 - x4C329 =e= 0;  
 965 EQU40..x5C326 - x5C329 =e= 0;  
 966 EQU41..x7C326 -x7C329 =e= 0;  
 967 EQU42..x1C403 + x3C403 + x4C403 + x5C403 + x7C403 =e= 1;  
 968 EQU43..x1C404 + x3C404 + x4C404 + x5C404 + x7C404 =e= 1;  
 969 EQU44..x1C405 + x3C405 + x4C405 + x5C405 + x7C405 =e= 1;  
 \_Economic Optimization Program

970 EQU45..x1C406 + x3C406 + x4C406 + x5C406 + x7C406 =e= 1;  
 971 EQU46..x1C407 + x3C407 + x4C407 + x5C407 + x7C407 =e= 1;  
 972 EQU47..x1C408 + x3C408 + x4C408 + x5C408 + x7C408 =e= 1;  
 973 EQU48..x1C409 + x3C409 + x4C409 + x5C409 + x7C409 =e= 1;  
 974 EQU49..x1C410 + x3C410 + x4C410 + x5C410 + x7C410 =e= 1;  
 975 EQU50..x1C411 + x3C411 + x4C411 + x5C411 + x7C411 =e= 1;  
 976 EQU51..x1C412 + x3C412 + x4C412 + x5C412 + x7C412 =e= 1;  
 977 EQU52..x1C413 + x3C413 + x4C413 + x5C413 + x7C413 =e= 1;  
 978 EQU53..x1C414 + x3C414 + x4C414 + x5C414 + x7C414 =e= 1;  
 979 EQU54..x1C415 + x3C415 + x4C415 + x5C415 + x7C415 =e= 1;  
 980 EQU55..x1C417 + x3C417 + x4C417 + x5C417 + x7C417 =e= 1;  
 981 EQU56..x1C418 + x2C418 + x3C418 + x4C418 + x5C418 + x7C418 =e= 1;  
 982 EQU57..x1C419 + x2C419 + x3C419 + x4C419 + x5C419 + x7C419 =e= 1;  
 983 EQU58..x1C303 + x3C303 + x4C303 + x5C303 + x7C303 =e= 1;  
 984 EQU59..x1C306 + x3C306 + x4C306 + x5C306 + x7C306 =e= 1;  
 985 EQU60..x1C307 + x3C307 + x4C307 + x5C307 + x7C307 =e= 1;  
 986 EQU61..x1C308 + x3C308 + x4C308 +x5C308 + x7C308=e= 1;  
 987 EQU62..x1C309 + x3C309 + x4C309 + x5C309 + x7C309 =e= 1;  
 988 EQU63..x1C310 + x3C310 + x4C310 + x5C310 + x7C310 =e= 1;  
 989 EQU64..x1C311 + x3C311 + x4C311 + x5C311 + x7C311 =e= 1;  
 990 EQU65..x1C312 + x3C312 + x4C312 + x5C312 + x7C312 =e= 1;  
 991 EQU66..x1C315 + x3C315 + x4C315 + x5C315 + x7C315 =e= 1;  
 992 EQU67..x1C316 + x3C316 + x4C316 + x5C316 + x7C316 =e= 1;  
 993 EQU68..x1C317 + x3C317 + x4C317 + x5C317 + x7C317 =e= 1;  
 994 EQU69..x1C318 + x3C318 + x4C318 + x5C318 + x7C318 =e= 1;  
 995 EQU70..x1C319 + x3C319 + x4C319 + x5C319 + x7C319 =e= 1;  
 996 EQU71..x1C320 + x3C320 + x4C320 + x5C320 + x7C320 =e= 1;  
 997 EQU72..x1C321 + x3C321 + x4C321 + x5C321 + x7C321 =e= 1;  
 998 EQU73..x1C322 + x3C322 + x4C322 + x5C322 + x7C322 =e= 1;  
 999 EQU74..x1C323 + x3C323 + x4C323 + x5C323 + x7C323 =e= 1;  
 1000 EQU75..x1C324 + x3C324 + x4C324 + x5C324 + x7C324 =e= 1;  
 1001 EQU76..(hC406 - hC407) - FcwE617\*4.197\*(TcwinoutE617 - Tcwin) =e= 0;  
 1002 EQU77..(hC406 - hC407) - UE617\*AE617\*FE617\*dTE617 =e= 0;  
 1003 EQU78..(hC405 - hC406) - (hC404 - hC403) =e= 0;  
 1004 EQU79..(hC405 - hC406) - UE616\*AE616\*dTE616\*FE616 =e= 0;  
 1005 EQU80..(hC408vap - hC408) - FstmE695A \* hstmE695 =e= 0;  
 1006 EQU81..(hC408vap - hC408) - UE695A\*AE695A\*dTE695A =e= 0;  
 1007 EQU82..(hC410vap - hC410) - FstmE696A \* hstmE696 =e= 0;  
 1008 EQU83..(hC410vap - hC410) - UE696A\*AE696A\*dTE696A =e= 0;  
 1009 EQU84..(hC412 - hC412liq) - FcwE627A\*4.197\*(TcwinoutE627A - Tcwin) =e= 0;  
 1010 EQU85..(hC412 - hC412liq) - UE627A\*FE627A\*AE627A\*dTE627A =e= 0;

1011 EQU86..(hC414 - hC414liq) - FcwE621A\*4.197\*(TcwotE621A - Tcwin) =e= 0;  
1012 EQU87..(hC414 - hC414liq) - UE621A\*FE621A\*AE621A\*dTE621A =e= 0;  
1013 EQU88..(hC418 - hC419) - FcwE626\*4.197\*(TcwoutE626 - Tcwin) =e= 0;  
1014 EQU89..(hC418 - hC419) - UE626\*AE626\*FE626\*dTE626 =e= 0;  
1015 EQU90..FC306 - FC307 =e= 0;  
\_Economic Optimization Program

05/15/01 16:49:39 PAGE 23  
GAMS 2.50A Windows NT/95/98

1016 EQU91..x1C306 - x1C307 =e= 0;  
1017 EQU92..FC414 - FC415 =e= 0;  
1018 EQU93..x1C414 - x1C415 =e= 0;  
1019 EQU94..x3C414 - x3C415 =e= 0;  
1020 EQU95..x4C414 - x4C415 =e= 0;  
1021 EQU96..x5C414 - x5C415 =e= 0;  
1022 EQU97..FC418 - FC419 =e= 0;  
1023 EQU98..x1C418 - x1C419 =e= 0;  
1024 EQU99..x3C418 - x3C419 =e= 0;  
1025 EQU100..x4C418 - x4C419 =e= 0;  
1026 EQU101..x5C418 - x5C419 =e= 0;  
1027 EQU102..hC431 - FC431\*  
1028 ((x3C431/MW3)\*(SUM(Coeff,1/ORD(Coeff)\* Enth\_liq("3",Coeff) \* POWER(TC431,ORD(Coeff))) + Enth\_Vap("3","a1")\*1000 \*  
((1-TC431/Enth\_Vap("3","a2"))\*\*Enth\_Vap("3","a3"))))  
1029 +(x4C431/MW4)\*(SUM(Coeff,1/ORD(Coeff)\* Enth\_liq("4",Coeff) \* POWER(TC431,ORD(Coeff))) + Enth\_Vap("4","a1")\*1000 \*  
((1-TC431/Enth\_Vap("4","a2"))\*\*Enth\_Vap("4","a3"))))  
1030 +(x5C431/MW5)\*(SUM(Coeff,1/ORD(Coeff)\* Enth\_liq("5",Coeff) \* POWER(TC431,ORD(Coeff))) + Enth\_Vap("5","a1")\*1000 \*  
((1-TC431/Enth\_Vap("5","a2"))\*\*Enth\_Vap("5","a3"))))  
1031 +(x7C431/MW7)\*(SUM(Coeff,1/ORD(Coeff)\* Enth\_liq("7",Coeff) \* POWER(TC431,ORD(Coeff))) + Enth\_Vap("7","a1")\*1000 \*  
((1-TC431/Enth\_Vap("7","a2"))\*\*Enth\_Vap("7","a3")))) =e= 0;  
1032 EQU103..hC412 - FC412 \*  
1033 ((x3C412/MW3)\*(SUM(Coeff,1/ORD(Coeff)\* Enth\_liq("3",Coeff) \* POWER(TC412,ORD(Coeff))) + Enth\_Vap("3","a1")\*1000 \*  
((1-TC412/Enth\_Vap("3","a2"))\*\*Enth\_Vap("3","a3"))))  
1034 +(x4C412/MW4)\*(SUM(Coeff,1/ORD(Coeff)\* Enth\_liq("4",Coeff) \* POWER(TC412,ORD(Coeff))) + Enth\_Vap("4","a1")\*1000 \*  
((1-TC412/Enth\_Vap("4","a2"))\*\*Enth\_Vap("4","a3"))))  
1035 +(x5C412/MW5)\*(SUM(Coeff,1/ORD(Coeff)\* Enth\_liq("5",Coeff) \* POWER(TC412,ORD(Coeff))) + Enth\_Vap("5","a1")\*1000 \*  
((1-TC412/Enth\_Vap("5","a2"))\*\*Enth\_Vap("5","a3"))))  
1036 +(x7C412/MW7)\*(SUM(Coeff,1/ORD(Coeff)\* Enth\_liq("7",Coeff) \* POWER(TC412,ORD(Coeff))) + Enth\_Vap("7","a1")\*1000 \*  
((1-TC412/Enth\_Vap("7","a2"))\*\*Enth\_Vap("7","a3")))) =e= 0;  
1037 EQU104..TmC603=e=(TC317+TC316)/2;  
1038 EQU105..K1C603\*PC603 =e= 0.1333\*10\*\*(21.4469-1.4627E3/TmC603-5.261\*LOG10(TmC603)+3.282E-11\*TmC603+3.7349E-6\*TmC603\*\*2);  
1039 EQU106..Kp1C603\*PC603 =e= 0.1333\*10\*\*(21.4469-1.4627E3/TmC603-5.261\*LOG10(TmC603)+3.282E-11\*TmC603+3.7349E-6\*TmC603\*\*2);  
1040 EQU107..K3C603\*PC603 =e= 0.1333\*10\*\*(31.2541-1.9532E3/TmC603-8.806\*LOG10(TmC603)+8.9246E-11\*TmC603+5.7501E-6\*TmC603\*\*2);  
1041 EQU108..Kp3C603\*PC603 =e= 0.1333\*10\*\*(31.2541-1.9532E3/TmC603-8.806\*LOG10(TmC603)+8.9246E-11\*TmC603+5.7501E-6\*TmC603\*\*2);  
1042 EQU109..K4C603\*PC603 =e= 0.1333\*10\*\*(27.0441-1.9049E3/TmC603-7.1805\*LOG10(TmC603)-6.6845E-11\*TmC603+4.219E-6\*TmC603\*\*2);  
1043 EQU110..Kp4C603\*PC603 =e= 0.1333\*10\*\*(27.0441-1.9049E3/TmC603-7.1805\*LOG10(TmC603)-6.6845E-11\*TmC603+4.219E-6\*TmC603\*\*2);  
1044 EQU111..K5C603\*PC603 =e= 0.1333\*10\*\*(29.2963-2.1762E3/TmC603-7.883\*LOG10(TmC603)-4.6512E-11\*TmC603+3.8997E-6\*TmC603\*\*2);  
1045 EQU112..Kp5C603\*PC603 =e= 0.1333\*10\*\*(29.2963-2.1762E3/TmC603-7.883\*LOG10(TmC603)-4.6512E-11\*TmC603+3.8997E-6\*TmC603\*\*2);  
1046 EQU113..K7C603\*PC603 =e= 0.1333\*10\*\*(33.0162-2.583E3/TmC603-9.042\*LOG10(TmC603)-1.371E-12\*TmC603+3.634E-6\*TmC603\*\*2);  
1047 EQU114..Kp7C603\*PC603 =e= 0.1333\*10\*\*(33.0162-2.583E3/TmC603-9.042\*LOG10(TmC603)-1.371E-12\*TmC603+3.634E-6\*TmC603\*\*2);  
1048 EQU115..Sn1C603\*FC329 =e= K1C603\*FC325;  
1049 EQU116..Sm1C603\*LpC603=e= Kp1C603\*VpC603;  
1050 EQU117..Sn3C603\*FC329 =e= K3C603\*FC325;  
1051 EQU118..Sm3C603\*LpC603=e= Kp3C603\*VpC603;  
1052 EQU119..Sn4C603\*FC329 =e= K4C603\*FC325;  
1053 EQU120..(hC306 - hC307) - FcwE634\*4.197\*(TcwoutE634 - Tcwin) =e= 0;  
\_Economic Optimization Program

05/15/01 16:49:39 PAGE 24  
GAMS 2.50A Windows NT/95/98

1054 EQU121..(hC306 - hC307) - UE634\*AE634\*FE634\*dTE634 =e= 0;  
1055 EQU122..(hC312liq - hC315) - FcwE641B\*4.197\*(TcwotE641B - Tcwin) =e= 0;  
1056 EQU123..(hC312liq - hC315) - UE641\*AE641\*FE641\*dTE641 =e= 0;  
1057 EQU124..(hC325 - hC326) - FcwE613\*4.197\*(TcwoutE613 - Tcwin) =e= 0;  
1058 EQU125..(hC325 - hC326) - UE613\*AE613\*dTE613 =e= 0;  
1059 EQU126..(hC324 - hC323) - FstmE612 \* hstmE612 =e= 0;  
1060 EQU127..(hC324 - hC323) - UE612\*AE612\*dTE612 =e= 0;  
1061 EQU128..FC325 - FC326 =e= 0;  
1062 EQU129..FC405 - FC406 =e= 0;  
1063 EQU130..hC409 - FC409 \*  
1064 ((x1C408/MW1)\*(SUM(Coeff,1/ORD(Coeff)\* Enth\_liq("1",Coeff) \* POWER(TC408,ORD(Coeff))))  
1065 +(x3C408/MW3)\*(SUM(Coeff,1/ORD(Coeff)\* Enth\_liq("3",Coeff) \* POWER(TC408,ORD(Coeff))))  
1066 +(x4C408/MW4)\*(SUM(Coeff,1/ORD(Coeff)\* Enth\_liq("4",Coeff) \* POWER(TC408,ORD(Coeff))))  
1067 +(x5C409/MW5)\*(SUM(Coeff,1/ORD(Coeff)\* Enth\_liq("5",Coeff) \* POWER(TC409,ORD(Coeff))))  
1068 +(x7C409/MW7)\*(SUM(Coeff,1/ORD(Coeff)\* Enth\_liq("7",Coeff) \* POWER(TC409,ORD(Coeff))) + Enth\_Vap("7","a1")\*1000 \*  
((1-TC409/Enth\_Vap("7","a2"))\*\*Enth\_Vap("7","a3")))) =e= 0;  
1069 EQU131..hC428 - FC428 \*  
1070 ((x3C428/MW3)\*(SUM(Coeff,1/ORD(Coeff)\* Enth\_liq("3",Coeff) \* POWER(TC428,ORD(Coeff))))  
1071 +(x4C428/MW4)\*(SUM(Coeff,1/ORD(Coeff)\* Enth\_liq("4",Coeff) \* POWER(TC428,ORD(Coeff))) + Enth\_Vap("4","a1")\*1000 \*  
((1-TC428/Enth\_Vap("4","a2"))\*\*Enth\_Vap("4","a3"))))  
1072 +(x5C428/MW5)\*(SUM(Coeff,1/ORD(Coeff)\* Enth\_liq("5",Coeff) \* POWER(TC428,ORD(Coeff))) + Enth\_Vap("5","a1")\*1000 \*  
((1-TC428/Enth\_Vap("5","a2"))\*\*Enth\_Vap("5","a3"))))  
1073 +(x7C428/MW7)\*(SUM(Coeff,1/ORD(Coeff)\* Enth\_liq("7",Coeff) \* POWER(TC428,ORD(Coeff))) + Enth\_Vap("7","a1")\*1000 \*  
((1-TC428/Enth\_Vap("7","a2"))\*\*Enth\_Vap("7","a3")))) =e= 0;  
1074 EQU132..Sm4C603\*LpC603=e= Kp4C603\*VpC603;  
1075 EQU133..Sn5C603\*FC329 =e= K5C603\*FC325;  
1076 EQU134..Sm5C603\*LpC603=e= Kp5C603\*VpC603;  
1077 EQU135..Sm7C603\*FC329 =e= K7C603\*FC325;  
1078 EQU136..Sm7C603\*LpC603=e= Kp7C603\*VpC603;  
1079 EQU137..f1C603\*((1-Sn1C603\*\*((40-17)/1E2+ RC603\*(1-Sn1C603)/1E2+ h1C603\*Sn1C603\*\*((40-17)\*(1-Sm1C603\*\*((17+1))/1E2) =e=  
(1-Sn1C603\*\*((40-17)/1E2+ RC603\*(1-Sn1C603)/1E2;  
1080 EQU138..f3C603\*((1-Sn3C603\*\*((40-17)+ RC603\*(1-Sn3C603) + h3C603\*Sn3C603\*\*((40-17)\*(1-Sm3C603\*\*((17+1))) =e= (1-Sn3C603\*\*((40-17)+ RC603\*(1-Sn3C603);

1081 EQU139..f4C603\*((1-Sn4C603\*\*(40-17)) + RC603\*(1-Sn4C603) + h4C603\*Sn4C603\*\*(40-17)\*(1-Sm4C603\*\*(17+1))) =e= (1-Sn4C603\*\*(40-17)) + RC603\*(1-Sn4C603);  
1082 EQU140..f5C603\*((1-Sn5C603\*\*(40-17)) + RC603\*(1-Sn5C603) + h5C603\*Sn5C603\*\*(40-17)\*(1-Sm5C603\*\*(17+1))) =e= (1-Sn5C603\*\*(40-17)) + RC603\*(1-Sn5C603);  
1083 EQU141..f7C603\*((1-Sn7C603\*\*(40-17)) + RC603\*(1-Sn7C603) + h7C603\*Sn7C603\*\*(40-17)\*(1-Sm7C603\*\*(17+1))) =e= (1-Sn7C603\*\*(40-17)) + RC603\*(1-Sn7C603);  
1084 EQU142..f1C603 \* x1C316 \* FC316 =e= x1C317 \* FC317;  
1085 EQU143..f3C603 \* x3C316 \* FC316 =e= x3C317 \* FC317;  
1086 EQU144..f4C603 \* x4C316 \* FC316 =e= x4C317 \* FC317;  
1087 EQU145..f5C603 \* x5C316 \* FC316 =e= x5C317 \* FC317;  
1088 EQU146..f7C603 \* x7C316 \* FC316 =e= x7C317 \* FC317;  
1089 EQU147..h1C603\*K1C603\*LpC603\*(1-Sm1C603) =e= Kp1C603\*FC329\*(1-Sn1C603);  
1090 EQU148..h3C603\*K3C603\*LpC603\*(1-Sm3C603) =e= Kp3C603\*FC329\*(1-Sn3C603);  
\_Economic Optimization Program 05/15/01 16:49:39 PAGE 25  
GAMS 2.50A Windows NT/95/98

1091 EQU149..h4C603\*K4C603\*LpC603\*(1-Sm4C603) =e= Kp4C603\*FC329\*(1-Sn4C603);  
1092 EQU150..h5C603\*K5C603\*LpC603\*(1-Sm5C603) =e= Kp5C603\*FC329\*(1-Sn5C603);  
1093 EQU151..h7C603\*K7C603\*LpC603\*(1-Sm7C603) =e= Kp7C603\*FC329\*(1-Sn7C603);  
1094 EQU152..K1C323\*PC603 =e= 0.1333\*10\*\*(21.4469-1.4627E3/TC323-5.261\*LOG10(TC323)+3.282E-11\*TC323+3.7349E-6\*TC323\*\*2);  
1095 EQU153..K3C323\*PC603 =e= 0.1333\*10\*\*(31.2541-1.9532E3/TC323-8.806\*LOG10(TC323)+8.9246E-11\*TC323+5.7501E-6\*TC323\*\*2);  
1096 EQU154..K4C323\*PC603 =e= 0.1333\*10\*\*(27.0441-1.9049E3/TC323-7.1805\*LOG10(TC323)-6.6845E-11\*TC323+4.219E-6\*TC323\*\*2);  
1097 EQU155..K5C323\*PC603 =e= 0.1333\*10\*\*(29.2963-2.1762E3/TC323-7.883\*LOG10(TC323)-4.6512E-11\*TC323+3.8997E-6\*TC323\*\*2);  
1098 EQU156..K7C323\*PC603 =e= 0.1333\*10\*\*(33.0162-2.583E3/TC323-9.042\*LOG10(TC323)-1.371E-12\*TC323+3.634E-6\*TC323\*\*2);  
1099 EQU157..K1C323\*xx1C323+K3C323\*xx3C323+K4C323\*xx4C323+K5C323\*xx5C323+K7C323\*xx7C323 =e= 1;  
1100 EQU158..FmC323 - FC323 \*(x1C323/MW1 + x3C323/MW3 + x4C323/MW4 + x5C323/MW5 + x7C323/MW7)=e= 0;  
1101 EQU159..xx1C323 \* MW1 \* FmC323 - FC323 \*x1C323=e= 0;  
1102 EQU160..xx3C323 \* MW3 \* FmC323 - FC323 \*x3C323=e= 0;  
1103 EQU161..xx4C323 \* MW4 \* FmC323 - FC323 \*x4C323=e= 0;  
1104 EQU162..xx5C323 \* MW5 \* FmC323 - FC323 \*x5C323=e= 0;  
1105 EQU163..xx1C323+xx3C323+xx4C323+xx5C323+xx7C323 =e= 1;  
1106 EQU164..dTE613\*2 =e= (TC325-TcwinoutE613) + (TC326-Tcwin);  
1108 EQU165..x1C325 -x1C326 =e= 0;  
1109 EQU166..x3C325 -x3C326 =e= 0;  
1110 EQU167..x4C325 -x4C326 =e= 0;  
1111 EQU168..FC418 - FC417 - FC415 =e= 0;  
1112 EQU169..(hC317 - hC318) - (hC316 - hC315) =e= 0;  
1113 EQU170..(hC317 - hC318) - UE610\*AE610\*dTE610\*FE610 =e= 0;  
1114 EQU171..(hC318 - hC319) - FcwE611\*4.197\*(TcwinoutE611 - Tcwin) =e= 0;  
1115 EQU172..(hC318 - hC319) - UE611\*AE611\*FE611\*dTE611 =e= 0;  
1116 EQU173..FC317 - FC318 =e= 0;  
1117 EQU174..FC318 - FC319 =e= 0;  
1118 EQU175..x1C318 - x1C319 =e= 0;  
1119 EQU176..x3C318 - x3C319 =e= 0;  
1120 EQU177..x4C318 - x4C319 =e= 0;  
1121 EQU178..x5C318 - x5C319 =e= 0;  
1122 EQU179..x1C405 - x1C406 =e= 0;  
1123 EQU180..x5C325 -x5C326 =e= 0;  
1124 EQU181..x1C325 + x3C325 +x4C325 +x5C325 +x7C325 =e= 1;  
1125 EQU182..x1C326 + x3C326 +x4C326 +x5C326 +x7C326 =e= 1;  
1126 EQU183..TC325-TC326 =e= 0;  
1127 EQU184..x1C326 -x1C328 =e= 0;  
1128 EQU185..x3C326 -x3C328 =e= 0;  
1129 EQU186..x4C326 -x4C328 =e= 0;  
1130 EQU187..x5C326 -x5C328 =e= 0;  
1131 EQU188..x7C326 -x7C328 =e= 0;  
1132 EQU189..K1C325\*PC603 =e= 0.1333\*10\*\*(21.4469-1.4627E3/TC325-5.261\*LOG10(TC325)+3.282E-11\*TC325+3.7349E-6\*TC325\*\*2);  
1133 EQU190..K3C325\*PC603 =e= 0.1333\*10\*\*(31.2541-1.9532E3/TC325-8.806\*LOG10(TC325)+8.9246E-11\*TC325+5.7501E-6\*TC325\*\*2);  
1134 EQU191..K4C325\*PC603 =e= 0.1333\*10\*\*(27.0441-1.9049E3/TC325-7.1805\*LOG10(TC325)-6.6845E-11\*TC325+4.219E-6\*TC325\*\*2);  
1135 EQU192..K5C325\*PC603 =e= 0.1333\*10\*\*(29.2963-2.1762E3/TC325-7.883\*LOG10(TC325)-4.6512E-11\*TC325+3.8997E-6\*TC325\*\*2);  
1136 EQU193..K7C325\*PC603 =e= 0.1333\*10\*\*(33.0162-2.583E3/TC325-9.042\*LOG10(TC325)-1.371E-12\*TC325+3.634E-6\*TC325\*\*2);  
\_Economic Optimization Program 05/15/01 16:49:39 PAGE 26  
GAMS 2.50A Windows NT/95/98

1137 EQU194..xx1C325/K1C325+xx3C325/K3C325+xx4C325/K4C325+xx5C325/K5C325+xx7C325/K7C325 =e= 1;  
1138 EQU195..FmC325 - FC325 \*(x1C325/MW1 + x3C325/MW3 + x4C325/MW4 + x5C325/MW5 + x7C325/MW7)=e= 0;  
1139 EQU196..xx1C325 \* MW1 \* FmC325 - FC325 \*x1C325=e= 0;  
1140 EQU197..xx3C325 \* MW3 \* FmC325 - FC325 \*x3C325=e= 0;  
1141 EQU198..xx4C325 \* MW4 \* FmC325 - FC325 \*x4C325=e= 0;  
1142 EQU199..xx5C325 \* MW5 \* FmC325 - FC325 \*x5C325=e= 0;  
1143 EQU200..xx1C325+xx3C325+xx4C325+xx5C325+xx7C325 =e= 1;  
1144 EQU201..hC309-hC310-hC311=e= 0;  
1145 EQU202..FAC07\*x11AC07 - FAC09\*x11AC09 - 0.06\*2.02\*FHC07\*x2HC07/(rhoHC07/1000) =e= 0;  
1146 EQU203..1000\*FAC09\*xiC11AC09 -riC11C623 \* VaC623 \* MWiC11 =e= 0;  
1147 EQU204..1000\*FAC09\*xiC10AC09 - riC10C623\*VaC623\*MWIC10 =e= 0;  
1148 EQU205..FHC07 +FHC34 + FAC07 =e= FAC09;  
1149 EQU206..1000\*FAC09\*x10AC09 - r10C623\*VaC623\*MW10 =e= 0;  
1150 EQU207..1000\*FAC09\*x9AC09 - r9C623\*VaC623\*MW9 =e= 0;  
1151 EQU208..1000\*FAC09\*x8AC09 - r8C623\*VaC623\*MW8 =e= 0;  
1152 EQU209..1000\*(FHC07\*x7HC07 + FHC34\*x7HC34 - FAC09\*x7AC09) + r7C623\*VaC623\*MW7 =e= 0;  
1153 EQU210..FC326 - FC328 - FC329 =e= 0;  
1154 EQU211..TC326 - TC328 =e= 0;  
1155 EQU212..TC326 - TC329 =e= 0;  
1156 EQU213..1000\*(FHC07\*x5HC07 + FHC34\*x5HC34 - FAC09\*x5AC09) + r5C623\*VaC623\*MW5 =e= 0;  
1157 EQU214..1000\*(FHC07\*x4HC07 + FHC34\*x4HC34 - FAC09\*x4AC09) + r4C623\*VaC623\*MW4 =e= 0;  
1158 EQU215..1000\*(FHC07\*x3HC07 + FHC34\*x3HC34 - FAC09\*x3AC09) - r3C623\*VaC623\*MW3 =e= 0;  
1159 EQU216..FHC07\*x1HC07 + FHC34\*x1HC34 - FAC09\*x1AC09 =e= 0;  
1160 EQU217..r4C623 =e= k2/1E12\*C4pC623\*C3C623;  
1161 EQU218..r5C623 =e= k3/1E12\*C5pC623\*C3C623;

1162 EQU219..r7C623 =e= k4/1E14\*C7pC623 \* C3C623;  
 1163 EQU220..r9C623 =e= k6/1E12\*C9pC623 \* C3C623;  
 1164 EQU221..r10C623 =e= k7/1E12\*C10pC623 \* C3C623;  
 1165 EQU222..riC10C623 =e= k8/1E12\* CiC10pC623 \* C3C623;  
 1166 EQU223..r8C623 =e= k5/1E12\*C8pC623\*C3C623;  
 1167 EQU224..riC11C623 =e=k18/1E12\*CiC11pC623\*C3C623;  
 1168 EQU225..r3C623 + r4C623 + r5C623 + r7C623 + r8C623 + r9C623 + r10C623 + riC10C623 + riC11C623 =e= 0;  
 1169 EQU226..1000\*(FHC07\*x2HC07 - FAC09\*x2AC09) - r2C623\*VaC623\*MW2 =e= 0;  
 1170 EQU227..-r2C623 + k1/1E6\*C2C623\*CHXC623 + k11/(1E9\*1E6)\*C3pC623 \*C2C623 + k15/(1E12\*1E6)\*C8pC623\*C2C623 + k19/(1E14\*1E6)  
 \*C7pC623\*C2C623=e=0;  
 1171 EQU228..k9/1E9\*C3pC623 - k10/(1E6\*1E9)\*CiC4eC623\*C3pC623 =e= 0;  
 1172 EQU229..k13/(1E11\*1E9)\*CiC8eC623\*C3pC623 +k17/1E12\*CiC11pC623 - k14/1E11\*CiC5eC623\*CHXC623 - k16/(1E11\*1E9)\*CiC5eC623\*C3pC623  
 =e= 0;  
 1173 EQU230..k12/1E12\*C9pC623 - k13/(1E11\*1E9)\*CiC8eC623\*C3pC623 =e=0;  
 1174 EQU231..k1/1E6\*C2C623\*CHXC623 - k2/1E12\*C4pC623\*C3C623 =e= 0;  
 1175 EQU232..r3C623 - k9/1E9\*C3pC623 - k10/(1E6\*1E9)\*CiC4eC623\*C3pC623 - k11/(1E6\*1E9)\*C3pC623\*C2C623 - k13/(1E11\*1E9)  
 \*CiC8eC623\*C3pC623 - k16/(1E11\*1E9) \* CiC5eC623\*C3pC623 =e= 0;  
 1176 EQU233..k14/1E11\*CiC5eC623\*CHXC623 - k3/1E12\*C5pC623\*C3C623 =e=0;  
 1177 EQU234..k17/1E12\*CiC11pC623 - k4/1E14\*C7pC623\*C3C623 - k19/(1E6\*1E14)\*C7pC623\*C2C623 =e= 0;  
 1178 EQU235..C2C623 /1E6=e= rhoAC09\*x2AC09/MW2;  
 1179 EQU236..C3C623 =e= rhoAC09\*x3AC09/MW3;  
 \_Economic Optimization Program

1180 EQU237..CHXC623 =e= rhoAC09\*x11AC09/MW11;  
 1181 EQU238..FAC09\*x1AC09 - FHC27\*x1HC27 =e=0;  
 1182 EQU239..FAC09\*x2AC09 - FHC27\*x2HC27 =e=0;  
 1183 EQU240..FAC09\*x3AC09 - FHC27\*x3HC27 =e=0;  
 1184 EQU241..FAC09\*x4AC09 - FHC27\*x4HC27 =e=0;  
 1185 EQU242..FAC09\*x5AC09 - FHC27\*x5HC27 =e=0;  
 1186 EQU243..x11AC05 - x11AC12 =e=0;  
 1187 EQU244..FAC05\*x11AC05 - sfC631\*FAC09\*x11AC09 =e=0;  
 1188 EQU245..FAC05\*x12AC05 - sfC631\*FAC09\*x12AC09 =e=0;  
 1189 EQU246..FAC09\*(x11AC09 + x12AC09) - FAC05 - FAC12 =e=0;  
 1190 EQU247..FAC09\*(x7AC09+x8AC09+x9AC09+x10AC09+xiC10AC09+xiC11AC09) - FHC27\*x7HC27 =e= 0;  
 1191 EQU248..x11AC07 + x12AC07 =e= 1;  
 1192 EQU249..K3C616\_A \* xx3C311 - xx3C310 =e= 0;  
 1193 EQU250..FC310 =e= VFC616\*FC309;  
 1194 EQU251..FC309 - FC310 - FC311 =e= 0;  
 1195 EQU252..FC309 \* x1C309 - FC311 \* x1C311 - FC310 \* x1C310 =e= 0;  
 1196 EQU253..FC309 \* x3C309 - FC310 \* x3C310 - FC311 \* x3C311 =e= 0;  
 1197 EQU254..FC309 \* x4C309 - FC310 \* x4C310 - FC311 \* x4C311 =e= 0;  
 1198 EQU255..FC309 \* x5C309 - FC310 \* x5C310 - FC311 \* x5C311 =e= 0;  
 1199 EQU256..K1C616\_A\* xx1C311 - xx1C310 =e= 0;  
 1200 EQU257..K7C616\_A \* xx7C311 - xx7C310 =e= 0;  
 1201 EQU258..K4C616\_A \* xx4C311 - xx4C310 =e= 0;  
 1202 EQU259..x1AC09 + x2AC09 + x3AC09 + x4AC09 + x5AC09 + x7AC09 + x8AC09 + x9AC09 + x10AC09 + x11AC09 + x12AC09 + xiC10AC09 +  
 xiC11AC09 =e= 1;  
 1203 EQU260..FAC07 -FAC05 - FAC02 =e= 0;  
 1204 EQU261..FAC07\*x11AC07 -FAC05\*x11AC05 - FAC02\*x11AC02 =e= 0;  
 1205 EQU262..x11AC05+x12AC05 =e=1;  
 1206 EQU263..x11AC02+x12AC02 =e=1;  
 1207 EQU264..k13/(1E11\*1E9)\*C3pC623\*CiC8eC623 - k5/1E12\*C8pC623\*C3C623 -k15/(1E6\*1E12)\*C8pC623\*C2C623 =e= 0;  
 1208 EQU265..k11/(1E6\*1E9)\*C2C623\*C3pC623 + k10/(1E6\*1E9)\*C3pC623\*CiC4eC623 - k6/1E12\*C9pC623\*C3C623 - k12/1E12\*C9pC623 =e= 0;  
 1209 EQU266..k16/(1E11\*1E9)\*CiC5eC623\*C3pC623 - k7/1E12\*C10pC623\*C3C623 =e= 0;  
 1210 EQU267..k19/(1E6\*1E14)\*C7pC623\*C2C623 - k8/1E12\*CiC10pC623\*C3C623 =e= 0;  
 1211 EQU268..k15/(1E6\*1E12)\*C8pC623\*C2C623 - k18/1E12\*CiC11pC623\*C3C623 - k17/1E12\*CiC11pC623 =e= 0;  
 1212 EQU269..x7C325 -x7C326 =e=0;  
 1213 EQU270..TC323 - TC324 =e= 0;  
 1214 EQU271..dT6E12 =e= 414.6 - TC323;  
 1215 EQU272..K1C615\_A\*PC308 =e= 0.1333\*10\*\*(21.4469-1.4627E3/TC308-5.261\*LOG10(TC308)+3.282E-11\*TC308+3.7349E-6\*TC308\*\*2);  
 1216 EQU273..K3C615\_A\*PC308 =e= 0.1333\*10\*\*(31.2541-1.9532E3/TC308-8.806\*LOG10(TC308)+8.9246E-11\*TC308+5.7501E-6\*TC308\*\*2);  
 1217 EQU274..K4C615\_A=e=0.13332\*EXP(15.6782-2154.90/(TC308-34.42))/PC308;  
 1218 EQU275..K5C615\_A=e=0.13332\*EXP(15.5338-2348.67/(TC308-40.05))/PC308;  
 1219 EQU276..K7C615\_A=e=0.13332\*EXP(15.7588-2633.90/(TC308-46.30))/PC308;  
 1220 EQU277..K1C616\_A\*PC310 =e= 0.1333\*10\*\*(21.4469-1.4627E3/TC310-5.261\*LOG10(TC310)+3.282E-11\*TC310+3.7349E-6\*TC310\*\*2);  
 1221 EQU278..K3C616\_A\*PC310 =e= 0.1333\*10\*\*(31.2541-1.9532E3/TC310-8.806\*LOG10(TC310)+8.9246E-11\*TC310+5.7501E-6\*TC310\*\*2);  
 1222 EQU279..x11AC12+x12AC12 =e=1;  
 1223 EQU280..FAC18 -FAC12 - FAC15 =e= 0;  
 1224 EQU281..FAC18\*x11AC18 -FAC12\*x11AC12 - FAC15\*x11AC15 =e= 0;  
 \_Economic Optimization Program

1225 EQU282..x11AC15+x12AC15 =e=1;  
 1226 EQU283..x11AC18 + x12AC18 =e= 1;  
 1227 EQU284..1000\*(FHC11\*x7HC11 + FHC38\*x7HC38 - FAC20\*x7AC20) + r7C625\*VaC623\*MW7 =e= 0;  
 1228 EQU285..r10C625 =e= k7/1E12\*C10pC625 \* C3C625;  
 1229 EQU286..r9C625 =e= k6/1E12\*C9pC625 \* C3C625;  
 1230 EQU287..r7C625 =e= k4/1E14\*C7pC625 \* C3C625;  
 1231 EQU288..r5C625 =e= k3/1E12\*C5pC625\*C3C625;  
 1232 EQU289..K5C616\_A \* xx5C311 - xx5C310 =e= 0;  
 1233 EQU290..FmC310 - FC310 \* (x1C310/MW1 + x3C310/MW3 + x4C310/MW4 + x5C310/MW5 + x7C310/MW7)=e= 0;  
 1234 EQU291..xx1C310\*MW1\*FmC310 - FC310 \* x1C310 =e= 0;  
 1235 EQU292..xx3C310 \* MW3 \* FmC310 - FC310 \* x3C310 =e= 0;  
 1236 EQU293..xx4C310 \* MW4 \* FmC310 - FC310 \* x4C310 =e= 0;  
 1237 EQU294..xx5C310 \* MW5 \* FmC310 - FC310 \* x5C310 =e= 0;  
 1238 EQU295..xx1C310 + xx3C310 + xx4C310 + xx5C310 + xx7C310 =e=1  
 1239 ;  
 1240 EQU296..FmC311 - FC311 \* (x1C311/MW1 + x3C311/MW3 + x4C311/MW4 + x5C311/MW5 + x7C311/MW7 )=e= 0;  
 1241 EQU297..xx1C311 \* MW1 \* FmC311 - FC311 \* x1C311 =e= 0;

1242 EQU298..xx3C311 \* MW3 \* FmC311 - FC311 \* x3C311 =e= 0;  
1243 EQU299..xx4C311 \* MW4 \* FmC311 - FC311 \* x4C311 =e= 0;  
1244 EQU300..xx5C311 \* MW5 \* FmC311 - FC311 \* x5C311 =e= 0;  
1245 EQU301..xx1C311+ xx3C311 + xx4C311 + xx5C311 + xx7C311 =e= 1;  
1246 EQU302..FC306 \* x1C306 - FC303 \* x1C303 - FC310 \* x1C310 =e= 0;  
1247 EQU303..FC306 \* x3C306 - FC303 \* x3C303 - FC310 \* x3C310 =e= 0;  
1248 EQU304..FC306 \* x4C306 - FC303 \* x4C303 - FC310 \* x4C310 =e= 0;  
1249 EQU305..FC306 \* x5C306 - FC303 \* x5C303 - FC310 \* x5C310 =e= 0;  
1250 EQU306..r4C625 =e= k2/1E12\*C4pC625\*C3C625;  
1251 EQU307..FHC11\*x1HC11 + FHC38\*x1HC38 - FAC20\*x1AC20 =e= 0;  
1252 EQU308..1000\*(FHC11\*x3HC11 + FHC38\*x3HC38 - FAC20\*x3AC20) - r3C625\*VaC623\*MW3 =e= 0;  
1253 EQU309..FAC18\*x11AC18 - FAC20\*x11AC20 - 0.06\*2.02\*FHC11\*x2HC11/(rho2HC11/1000) =e= 0;  
1254 EQU310..1000\*(FHC11\*x5HC11 + FHC38\*x5HC38 - FAC20\*x5AC20) + r5C625\*VaC623\*MW5 =e= 0;  
1255 EQU311..riC11C625 =e= k18/1E12\*Cic11pC625\*C3C625;  
1256 EQU312..1000\*FAC20\*x8AC20 - r8C625\*VaC623\*MW8 =e= 0;  
1257 EQU313..1000\*FAC20\*x9AC20 - r9C625\*VaC623\*MW9 =e= 0;  
1258 EQU314..1000\*FAC20\*x10AC20 - r10C625\*VaC623\*MW10 =e= 0;  
1259 EQU315..FHC11 + FHC38 + FAC18 =e= FAC20;  
1260 EQU316..1000\*FAC20\*xiC10AC20 - riC10C625\*VaC623\*MWic10 =e= 0;  
1261 EQU317..1000\*FAC20\*xiC11AC20 - riC11C625 \* VaC623 \* MWic11 =e= 0;  
1262 EQU318..1000\*(FHC11\*x4HC11 + FHC38\*x4HC38 - FAC20\*x4AC20) + r4C625\*VaC623\*MW4 =e= 0;  
1263 EQU319..r3C625 - k9/1E9\*C3pC625 - k10/(1E6\*1E9)\*Cic4eC625\*C3pC625 - k11/(1E6\*1E9)\*C3pC625\*C2C625 - k13/(1E11\*1E9)  
\*CiC8eC625\*C3pC625 - k16/(1E11\*1E9) \* CiC5eC625\*C3pC625 =e= 0;  
1264 EQU320..k19/(1E6\*1E14)\*C7pC625\*C2C625 - k8/1E12\*Cic10pC625\*C3C625 =e= 0;  
1265 EQU321..k16/(1E11\*1E9)\*CiC5eC625\*C3pC625 - k7/1E12\*C10pC625\*C3C625 =e= 0;  
1266 EQU322..k11/(1E6\*1E9)\*C2C625\*C3pC625 + k10/(1E6\*1E9)\*C3pC625\*CiC4eC625 - k6/1E12\*C9pC625\*C3C625 - k12/1E12\*C9pC625 =e= 0;  
1267 EQU323..k13/(1E11\*1E9)\*C3pC625\*CiC8eC625 - k5/1E12\*C8pC625\*C3C625 - k15/(1E6\*1E12)\*C8pC625\*C2C625 =e= 0;  
1268 EQU324..CHXC625 =e= rhoAC20\*x11AC20/MW11;  
1269 EQU325..C3C625 =e= rhoAC20\*x3AC20/MW3;  
\_Economic Optimization Program

1270 EQU326..C2C625/1E6 =e= rhoAC20\*x2AC20/MW2;  
1271 EQU327..riC10C625 =e= k8/1E12\* Cic10pC625 \* C3C625;  
1272 EQU328..k14/1E11\*CiC5eC625\*CHXC625 - k3/1E12\*C5pC625\*C3C625 =e= 0;  
1273 EQU329..r8C625 =e= k5/1E12\*C8pC625\*C3C625;  
1274 EQU330..k1/1E6\*C2C625\*CHXC625 - k2/1E12\*C4pC625\*C3C625 =e= 0;  
1275 EQU331..k12/1E12\*C9pC625 - k13/(1E11\*1E9)\*CiC8eC625\*C3pC625 =e= 0;  
1276 EQU332..k13/(1E11\*1E9)\*CiC8eC625\*C3pC625 + k17/1E12\*Cic11pC625 - k14/1E11\*CiC5eC625\*CHXC625 - k16/(1E11\*1E9)\*CiC5eC625\*C3pC625  
=e= 0;  
1277 EQU333..k9/1E9\*C3pC625 - k10/(1E6\*1E9)\*CiC4eC625\*C3pC625 =e= 0;  
1278 EQU334..-r2C625 + k1/1E6\*C2C625\*CHXC625 + k11/(1E9\*1E6)\*C3pC625 \*C2C625 + k15/(1E12\*1E6)\*C8pC625\*C2C625 + k19/(1E14\*1E6)  
\*C7pC625\*C2C625=e=0;  
1279 EQU335..1000\*(FHC11\*x2HC11 - FAC20\*x2AC20) - r2C625\*VaC623\*MW2 =e= 0;  
1280 EQU336..-r3C625 + r4C625 + r5C625 + r7C625 + r8C625 + r9C625 + r10C625 + riC10C625 + riC11C625 =e= 0;  
1281 EQU337..k15/(1E6\*1E12)\*C8pC625\*C2C625 - k18/1E12\*Cic11pC625\*C3C625 - k17/1E12\*Cic11pC625 =e= 0;  
1282 EQU338..k17/1E12\*Cic11pC625 - k4/1E14\*C7pC625\*C3C625 - k19/(1E6\*1E14)\*C7pC625\*C2C625 =e= 0;  
1283 EQU339..x1HC08 + x2HC08 + x3HC08 + x4HC08 + x5HC08 + x7HC08 =e= 1;  
1284 EQU340..FC307 - FC308 - FC312 =e= 0;  
1285 EQU341..FC307 \* x1C307 - FC308 \* x1C308 - FC312 \* x1C312 =e= 0;  
1286 EQU342..FC307 \* x3C307 - FC308 \* x3C308 - FC312 \* x3C312 =e= 0;  
1287 EQU343..FC307 \* x4C307 - FC308 \* x4C308 - FC312 \* x4C312 =e= 0;  
1288 EQU344..FC307 \* x5C307 - FC308 \* x5C308 - FC312 \* x5C312 =e= 0;  
1289 EQU345..x1AC20 + x2AC20 + x3AC20 + x4AC20 + x5AC20 + x7AC20 + x8AC20 + x9AC20 + x10AC20 + x11AC20 + x12AC20 + xiC10AC20 +  
xiC11AC20 =e= 1;  
1290 EQU346..FAC20\*(x7AC20+x8AC20+x9AC20+x10AC20+xiC10AC20+xiC11AC20) - FHC25\*x7HC25 =e= 0;  
1291 EQU347..FAC20\*(x11AC20 + x12AC20) - FAC15 - FAC23 =e= 0;  
1292 EQU348..FAC15\*x12AC15 - sfC632\*FAC20\*x12AC20 =e= 0;  
1293 EQU349..FAC15\*x11AC15 - sfC632\*FAC20\*x11AC20 =e= 0;  
1294 EQU350..x11AC15 - x11AC23 =e= 0;  
1295 EQU351..FAC20\*x5AC20 - FHC25\*x5HC25 =e= 0;  
1296 EQU352..FAC20\*x4AC20 - FHC25\*x4HC25 =e= 0;  
1297 EQU353..FAC20\*x3AC20 - FHC25\*x3HC25 =e= 0;  
1298 EQU354..FAC20\*x2AC20 - FHC25\*x2HC25 =e= 0;  
1299 EQU355..FAC20\*x1AC20 - FHC25\*x1HC25 =e= 0;  
1300 EQU356..dTE641\*\*3 - ((TC312-TcwotE641B)\*(TC315-Tcwin)\*)  
1301 ((TC312-TcwotE641B)+(TC315-Tcwin))/2 =e= 0;  
1302 EQU357..dTE611\*\*3 =e= ((TC318-TcwoutE611)\*(TC319-Tcwin)\*)  
1303 ((TC318-TcwoutE611)+(TC319-Tcwin))/2);  
1304 EQU358..dTE610\*\*3 =e= ((TC317-TC316)\*(TC318-TC315)\*)  
1305 ((TC317-TC316)+(TC318-TC315))/2);  
1306 EQU359..x11AC23+x12AC23 =e= 1;  
1307 EQU360..x11AC29 + x12AC29 =e= 1;  
1308 EQU361..x11AC26+x12AC26 =e= 1;  
1309 EQU362..x1AC31 + x2AC31 + x3AC31 + x4AC31 + x5AC31 +x7AC31 + x8AC31 + x9AC31 + x10AC31 + x11AC31 + x12AC31 + xiC10AC31 +  
xiC11AC31 =e= 1;  
1310 EQU363..Q2HC14 - FHC14 \* x2HC14/(rho2HC14/1000) =e= 0;  
1311 EQU364..QHC14 - FHC14/0.575 =e= 0;  
\_Economic Optimization Program

1312 EQU365..x1HC14 + x2HC14 + x3HC14 + x4HC14 + x5HC14 + x7HC14 =e= 1;  
1313 EQU366..QHC41 - FHC41/0.575 =e= 0;  
1314 EQU367..x1HC41 +x3HC41 + x4HC41 + x5HC41 + x7HC41 =e= 1;  
1315 EQU368..FAC29 -FAC23 - FAC26 =e= 0;  
1316 EQU369..FAC29\*x11AC29 -FAC23\*x11AC23 - FAC26\*x11AC26 =e= 0;  
1317 EQU370..FAC31\*x1AC31 - FHC23\*x1HC23 =e= 0;  
1318 EQU371..FAC31\*x2AC31 - FHC23\*x2HC23 =e= 0;  
1319 EQU372..FAC31\*x3AC31 - FHC23\*x3HC23 =e= 0;  
1320 EQU373..FAC31\*x4AC31 - FHC23\*x4HC23 =e= 0;

1321 EQU374..K1C615\_A \* xx1C308 - xx1C312 =e= 0;  
1322 EQU375..K7C615\_A \* xx7C308 - xx7C312 =e= 0;  
1323 EQU376..K4C615\_A \* xx4C308 - xx4C312 =e= 0;  
1324 EQU377..K5C615\_A \* xx5C308 - xx5C312 =e= 0;  
1325 EQU378..TC312 - TC308 =e= 0;  
1326 EQU379..TC312 - TC307 =e= 0;  
1327 EQU380..FmC312 - FC312 \* (x1C312/MW1 + x3C312/MW3 + x4C312/MW4 + x5C312/MW5 + x7C312/MW7)=e= 0;  
1328 EQU381..xx1C312 \* MW1 \* FmC312 - FC312 \* x1C312 =e= 0;  
1329 EQU382..xx3C312 \* MW3 \* FmC312 - FC312 \* x3C312 =e= 0;  
1330 EQU383..xx4C312 \* MW4 \* FmC312 - FC312 \* x4C312 =e= 0;  
1331 EQU384..xx5C312 \* MW5 \* FmC312 - FC312 \* x5C312 =e= 0;  
1332 EQU385..FmC308 - FC308 \* (x1C308/MW1 + x3C308/MW3 + x4C308/MW4 + x5C308/MW5 + x7C308/MW7)=e= 0;  
1333 EQU386..xx1C308 \* MW1 \* FmC308 - FC308 \* x1C308=e= 0;  
1334 EQU387..xx3C308 \* MW3 \* FmC308 - FC308 \* x3C308=e= 0;  
1335 EQU388..xx4C308 \* MW4 \* FmC308 - FC308 \* x4C308=e= 0;  
1336 EQU389..xx5C308 \* MW5 \* FmC308 - FC308 \* x5C308=e= 0;  
1337 EQU390..xx1C308+ xx3C308+ xx4C308+ xx5C308+ xx7C308=e=1;  
1338 EQU391..FC306 - FC303 - FC310 =e= 0;  
1339 EQU392..1000\*kWad1=e= kK601/(kK601 -1)\*FC303\*8314/55.5\*TC303\*((PC310/PC303)\*\*((kK601 -1)/kK601) -1);  
1340 EQU393..1000\*kWad2=e= kK601/(kK601 -1)\*FC306\*8314/55.5\*TmK601\*((PC306/PC310)\*\*((kK601 -1)/kK601) -1);  
1341 EQU394..hC307 - FC307 \* ((x1C307/MW1)\*(SUM(Coeff,1/ORD(Coeff))\* Enth\_liq("1",Coeff) \*POWER(TC307,ORD(Coeff))))  
1342 + (x3C307/MW3)\*(SUM(Coeff,1/ORD(Coeff))\* Enth\_liq("3",Coeff) \* POWER(TC307,ORD(Coeff))))  
1343 + (x4C307/MW4)\*(SUM(Coeff,1/ORD(Coeff))\* Enth\_liq("4",Coeff) \* POWER(TC307,ORD(Coeff))))  
1344 + (x5C307/MW5)\*(SUM(Coeff,1/ORD(Coeff))\* Enth\_liq("5",Coeff) \* POWER(TC307,ORD(Coeff))))  
1345 + (x7C307/MW7)\*(SUM(Coeff,1/ORD(Coeff))\* Enth\_liq("7",Coeff) \* POWER(TC307,ORD(Coeff)))) =e= 0;  
1346 EQU395..x4C306 - x4C307 =e= 0;  
1347 EQU396..x5C306 - x5C307 =e= 0;  
1348 EQU397..FC312 - FC315 =e= 0;  
1349 EQU398..x1C312 - x1C315 =e= 0;  
1350 EQU399..FC315 - FC316 =e= 0;  
1351 EQU400..x1C315 - x1C316 =e= 0;  
1352 EQU401..x3C315 - x3C316 =e= 0;  
1353 EQU402..PC309=e=PC308-deltaPE640;  
1354 EQU403..dTE640\*\*3=e= ((TC308-TcwinE640)\*(TC309-Tcwin)\*  
1355 ((TC308-TcwinE640)+(TC309-Tcwin))/2);  
1356 EQU404..x3C405 - x3C406 =e= 0;  
1357 EQU405..FC406 - FC407 =e= 0;  
\_Economic Optimization Program

1358 EQU406..x1C406 - x1C407 =e= 0;  
1359 EQU407..FC410 - FC411 =e= 0;  
1360 EQU408..x3C312 - x3C315 =e= 0;  
1361 EQU409..x4C312 - x4C315 =e= 0;  
1362 EQU410..x5C312 - x5C315 =e= 0;  
1363 EQU411..FAC31\*x5AC31 - FHC23\*x5HC23 =e=0;  
1364 EQU412..x11AC26 - x11AC34 =e=0;  
1365 EQU413..FAC26\*x11AC26 - sfC633\*FAC31\*x11AC31 =e=0;  
1366 EQU414..FAC26\*x12AC26 - sfC633\*FAC31\*x12AC31 =e=0;  
1367 EQU415..FAC31\*(x11AC31 + x12AC31) - FAC26 - FAC34 =e=0;  
1368 EQU416..FAC31\*(x7AC31+x8AC31+x9AC31+x10AC31+xiC11AC31) - FHC23\*x7HC23 =e= 0;  
1369 EQU417..FAC29\*x11AC29 - FAC31\*x11AC31 - 0.06\*2.02\*FHC14\*x2HC14/(rho2HC14/1000) =e= 0;  
1370 EQU418..1000\*(FHC14\*x7HC14 + FHC41\*x7HC41 - FAC31\*x7AC31) + r7C627\*VaC623\*MW7 =e= 0;  
1371 EQU419..1000\*FAC31\*xiC11AC31 - riC11C627 \* VaC623 \* MWIC11 =e= 0;  
1372 EQU420..1000\*FAC31\*xiC10AC31 - riC10C627\*VaC623\*MWIC10 =e= 0;  
1373 EQU421..FHC14 + FHC41 + FAC29 =e= FAC31;  
1374 EQU422..1000\*FAC31\*x10AC31 - r10C627\*VaC623\*MW10 =e= 0;  
1375 EQU423..1000\*FAC31\*x9AC31 - r9C627\*VaC623\*MW9 =e= 0;  
1376 EQU424..1000\*FAC31\*x8AC31 - r8C627\*VaC623\*MW8 =e= 0;  
1377 EQU425..r3C627 - k9/1E9\*C3pC627 - k10/(1E6\*1E9)\*CiC4eC627\*C3pC627 - k11/(1E6\*1E9)\*C3pC627\*C2C627 - k13/(1E11\*1E9)  
\*CiC8eC627\*C3pC627 - k16/(1E11\*1E9) \* CiC5eC627\*C3pC627 =e= 0;  
1378 EQU426..1000\*(FHC14\*x5HC14 + FHC41\*x5HC41 - FAC31\*x5AC31) + r5C627\*VaC623\*MW5 =e= 0;  
1379 EQU427..k19/(1E6\*1E14)\*C7pC627\*C2C627 - k8/1E12\*CiC10pC627\*C3C627 =e= 0;  
1380 EQU428..1000\*(FHC14\*x3HC14 + FHC41\*x3HC41 - FAC31\*x3AC31) - r3C627\*VaC623\*MW3 =e= 0;  
1381 EQU429..FHC14\*x1HC14 + FHC41\*x1HC41 - FAC31\*x1AC31 =e= 0;  
1382 EQU430..r4C627 =e= k2/1E12\*C4pC627\*C3C627;  
1383 EQU431..r5C627 =e= k3/1E12\*C5pC627\*C3C627;  
1384 EQU432..r7C627 =e= k4/1E14\*C7pC627 \* C3C627;  
1385 EQU433..r9C627 =e= k6/1E12\*C9pC627 \* C3C627;  
1386 EQU434..r10C627 =e= k7/1E12\*C10pC627 \* C3C627;  
1387 EQU435..riC11C627 =e=k18/1E12\*CiC11pC627\*C3C627;  
1388 EQU436..k14/1E11\*CiC5eC627\*CHXC627 - k3/1E12\*C5pC627\*C3C627 =e=0;  
1389 EQU437..k15/(1E6\*1E12)\*C8pC627\*C2C627 - k18/1E12\*CiC11pC627\*C3C627 - k17/1E12\*CiC11pC627 =e= 0;  
1390 EQU438..r3C627 + r4C627 + r5C627 + r7C627 + r8C627 + r9C627 + r10C627 + riC10C627 + riC11C627 =e= 0;  
1391 EQU439..1000\*(FHC14\*x2HC14 - FAC31\*x2AC31) - r2C627\*VaC623\*MW2 =e= 0;  
1392 EQU440..r2C627 + k1/1E6\*C2C627\*CHXC627 + k11/(1E9\*1E6)\*C3pC627 \*C2C627 + k15/(1E12\*1E6)\*C8pC627\*C2C627 + k19/(1E14\*1E6)  
\*C7pC627\*C2C627=e=0;  
1393 EQU441..k9/1E9\*C3pC627 - k10/(1E6\*1E9)\*CiC4eC627\*C3pC627 =e= 0;  
1394 EQU442..k13/(1E11\*1E9)\*CiC8eC627\*C3pC627 +k17/1E12\*CiC11pC627 - k14/1E11\*CiC5eC627\*CHXC627 - k16/(1E11\*1E9)\*CiC5eC627\*C3pC627  
=e= 0;  
1395 EQU443..k12/1E12\*C9pC627 - k13/(1E11\*1E9)\*CiC8eC627\*C3pC627 =e=0;  
1396 EQU444..1000\*(FHC14\*x4HC14 + FHC41\*x4HC41 - FAC31\*x4AC31) + r4C627\*VaC623\*MW4 =e= 0;  
1397 EQU445..r8C627 =e= k5/1E12\*C8pC627\*C3C627;  
1398 EQU446..k17/1E12\*CiC11pC627 - k4/1E14\*C7pC627\*C3C627 - k19/(1E6\*1E14)\*C7pC627\*C2C627 =e= 0;  
1399 EQU447..riC10C627 =e= k8/1E12\* CiC10pC627 \* C3C627;  
1400 EQU448..C2C627/1E6 =e= rhoAC31\*x2AC31/MW2;  
\_Economic Optimization Program

1401 EQU449..C3C627 =e= rhoAC31\*x3AC31/MW3;

1402 EQU450..CHXC627 =e= rhoAC31\*x11AC31/MW11;  
1403 EQU451..k13/(1E11\*1E9)\*C3pC627\*CIC8eC627 - k5/1E12\*C8pC627\*C3C627 -k15/(1E6\*1E12)\*C8pC627\*C2C627 =e= 0;  
1404 EQU452..k11/(1E6\*1E9)\*C2C627\*C3pC627 + k10/(1E6\*1E9)\*C3pC627\*CIC4eC627 - k6/1E12\*C9pC627\*C3C627 - k12/1E12\*C9pC627 =e= 0;  
1405 EQU453..x4C315 - x4C316 =e= 0;  
1406 EQU454..x5C315 - x5C316 =e= 0;  
1407 EQU455..x1C317 - x1C318 =e= 0;  
1408 EQU456..x3C317 - x3C318 =e= 0;  
1409 EQU457..x4C317 - x4C318 =e= 0;  
1410 EQU458..x5C317 - x5C318 =e= 0;  
1411 EQU459..FC319 - FC320 - FC321 - FC322 =e= 0;  
1412 EQU460..FC319 \* x1C319 - FC320 \* x1C320 - FC321 \* x1C321 - FC322 \* x1C322 =e= 0;  
1413 EQU461..FC319 \* x3C319 - FC320 \* x3C320 - FC321 \* x3C321 - FC322 \* x3C322 =e= 0;  
1414 EQU462..FC319 \* x4C319 - FC320 \* x4C320 - FC321 \* x4C321 - FC322 \* x4C322 =e= 0;  
1415 EQU463..FC319 \* x5C319 - FC320 \* x5C320 - FC321 \* x5C321 - FC322 \* x5C322 =e= 0;  
1416 EQU464..FC319 \* sf1S34 - FC320 =e= 0;  
1417 EQU465..x1C319 - x1C320 =e= 0;  
1418 EQU466..x3C319 - x3C320 =e= 0;  
1419 EQU467..x4C319 - x4C320 =e= 0;  
1420 EQU468..k16/(1E11\*1E9)\*CIC5eC627\*C3pC627 - k7/1E12\*C10pC627\*C3C627 =e= 0;  
1421 EQU469..k1/1E6\*C2C627\*CHXC627 - k2/1E12\*C4pC627\*C3C627 =e= 0;  
1422 EQU470..x1HC23+x2HC23+x3HC23+x4HC23+x5HC23+x7HC23 =e=1;  
1423 EQU471..x11AC34+x12AC34 =e=1;  
1424 EQU472..x1HC22+x2HC22+x3HC22+x4HC22+x5HC22+x7HC22 =e=1;  
1425 EQU473..x11AC37+x12AC37 =e=1;  
1426 EQU474..x11AC40 + x12AC40 =e= 1;  
1427 EQU475..x1AC42 + x2AC42 + x3AC42 + x4AC42 + x5AC42 +x7AC42 + x8AC42 + x9AC42 + x10AC42 + x11AC42 + x12AC42 + xiC10AC42 + xiC11AC42 =e= 1;

1428 EQU476..x11AC45+x12AC45 =e=1;  
1429 EQU477..Q2HC16 - FHC16 \* x2HC16/(rho2HC16/1000) =e= 0;  
1430 EQU478..QHC16 - FHC16/0.575 =e= 0;  
1431 EQU479..x1HC16 + x2HC16 + x3HC16 + x4HC16 + x5HC16 + x7HC16 =e= 1;  
1432 EQU480..FAC40 -FAC34 - FAC37 =e= 0;  
1433 EQU481..FAC40\*x11AC40 -FAC34\*x11AC34 - FAC37\*x11AC37 =e= 0;  
1434 EQU482..FAC42\*(x7AC42+x8AC42+x9AC42+x10AC42+xiC10AC42+xiC11AC42) - FHC22\*x7HC22 =e= 0;  
1435 EQU483..FAC42\*(x11AC42 + x12AC42) - FAC37 - FAC45 =e=0;  
1436 EQU484..FAC37\*x12AC37 - sfC634\*FAC42\*x12AC42 =e=0;  
1437 EQU485..FAC37\*x11AC37 - sfC634\*FAC42\*x11AC42 =e=0;  
1438 EQU486..x11AC37 - x11AC45 =e=0;  
1439 EQU487..FAC42\*x5AC42 - FHC22\*x5HC22 =e=0;  
1440 EQU488..FAC42\*x4AC42 - FHC22\*x4HC22 =e=0;  
1441 EQU489..FAC42\*x3AC42 - FHC22\*x3HC22 =e=0;  
1442 EQU490..FAC42\*x2AC42 - FHC22\*x2HC22 =e=0;  
1443 EQU491..FAC42\*x1AC42 - FHC22\*x1HC22 =e=0;  
1444 EQU492..r3C629 - k9/1E9\*C3pC629 - k10/(1E6\*1E9)\*CIC4eC629\*C3pC629 - k11/(1E6\*1E9)\*C3pC629\*C2C629 - k13/(1E11\*1E9)\*CIC8eC629\*C3pC629 - k16/(1E11\*1E9)\*CIC5eC629\*C3pC629 =e= 0;

\_Economic Optimization Program 05/15/01 16:49:39 PAGE 33  
GAMS 2.50A Windows NT/95/98

1445 EQU493..FAC40\*x11AC40 - FAC42\*x11AC42 - 0.06\*2.02\*FHC16\*x2HC16/(rho2HC16/1000) =e= 0;  
1446 EQU494..r9C629 =e= k6/1E12\*C9pC629 \* C3C629;  
1447 EQU495..r7C629 =e= k4/1E14\*C7pC629 \* C3C629;  
1448 EQU496..x5C319 - x5C320 =e= 0;  
1449 EQU497..x1C319 - x1C321 =e= 0;  
1450 EQU498..x3C319 - x3C321 =e= 0;  
1451 EQU499..x4C319 - x4C321 =e= 0;  
1452 EQU500..x5C319 - x5C321 =e= 0;  
1453 EQU501..FC308 - FC309 =e= 0;  
1454 EQU502..x1C308 - x1C309 =e= 0;  
1455 EQU503..(hC308 - hC309) - FcwE640\*4.197\*(TcwoutE640 - Tcwin) =e= 0;  
1456 EQU504..FC316 + FC329 - FC317 - FC325 =e= 0;  
1457 EQU505..FC316 \* x1C316 + FC329\*x1C329 - FC317 \* x1C317 - FC325\*x1C325 =e= 0;  
1458 EQU506..r5C629 =e= k3/1E12\*C5pC629\*C3C629;  
1459 EQU507..r4C629 =e= k2/1E12\*C4pC629\*C3C629;  
1460 EQU508..FHC16\*x1HC16 + FHC45\*x1HC45 - FAC42\*x1AC42 =e= 0;  
1461 EQU509..1000\*(FHC16\*x3HC16 + FHC45\*x3HC45 - FAC42\*x3AC42) - r3C629\*VaC623\*MW3 =e= 0;  
1462 EQU510..riC11C629 =e=k18/1E12\*CIC11pC629\*C3C629;  
1463 EQU511..1000\*(FHC16\*x5HC16 + FHC45\*x5HC45 - FAC42\*x5AC42) + r5C629\*VaC623\*MW5 =e= 0;  
1464 EQU512..k14/1E11\*CIC5eC629\*CHXC629 - k3/1E12\*C5pC629\*C3C629 =e=0;  
1465 EQU513..1000\*FAC42\*x8AC42 - r8C629\*VaC623\*MW8 =e= 0;  
1466 EQU514..1000\*FAC42\*x9AC42 - r9C629\*VaC623\*MW9 =e= 0;  
1467 EQU515..1000\*FAC42\*x10AC42 - r10C629\*VaC623\*MW10 =e= 0;  
1468 EQU516..FHC16 +FHC45 + FAC40 =e= FAC42;  
1469 EQU517..1000\*FAC42\*xiC10AC42 - riC10C629\*VaC623\*MWIC10 =e= 0;  
1470 EQU518..1000\*FAC42\*xiC11AC42 - riC11C629 \* VaC623 \* MWIC11 =e= 0;  
1471 EQU519..1000\*(FHC16\*x7HC16 + FHC45\*x7HC45 - FAC42\*x7AC42) + r7C629\*VaC623\*MW7 =e= 0;  
1472 EQU520..k19/(1E14\*1E6)\*C7pC629\*C2C629 - k8/1E12\*CIC10pC629\*C3C629 =e= 0;  
1473 EQU521..1000\*(FHC16\*x4HC16 + FHC45\*x4HC45 - FAC42\*x4AC42) + r4C629\*VaC623\*MW4 =e= 0;  
1474 EQU522..k16/(1E11\*1E9)\*CIC5eC629\*C3pC629 - k7/1E12\*C10pC629\*C3C629 =e= 0;  
1475 EQU523..k11/(1E6\*1E9)\*C2C629\*C3pC629 + k10/(1E6\*1E9)\*C3pC629\*CIC4eC629 - k6/1E12\*C9pC629\*C3C629 - k12/1E12\*C9pC629 =e= 0;  
1476 EQU524..k13/(1E11\*1E9)\*C3pC629\*CIC8eC629 - k5/1E12\*C8pC629\*C3C629 -k15/(1E6\*1E12)\*C8pC629\*C2C629 =e= 0;  
1477 EQU525..CHXC629 =e= rhoAC42\*x11AC42/MW11;  
1478 EQU526..C3C629 =e= rhoAC42\*x3AC42/MW3;  
1479 EQU527..C2C629/1E6 =e= rhoAC42\*x2AC42/MW2;  
1480 EQU528..riC10C629 =e= k8/1E12\* CiC10pC629 \* C3C629;  
1481 EQU529..r10C629 =e= k7/1E12\*C10pC629 \* C3C629;  
1482 EQU530..r8C629 =e= k5/1E12\*C8pC629\*C3C629;  
1483 EQU531..k1/1E6\*C2C629\*CHXC629 - k2/1E12\*C4pC629\*C3C629 =e= 0;  
1484 EQU532..k12/1E12\*C9pC629 - k13/(1E11\*1E9)\*CIC8eC629\*C3pC629 =e=0;  
1485 EQU533..k13/(1E11\*1E9)\*CIC8eC629\*C3pC629 +k17/1E12\*CIC11pC629 - k14/1E11\*CIC5eC629\*CHXC629 - k16/(1E11\*1E9)\*CIC5eC629\*C3pC629 =e= 0;

1486 EQU534..k9/1E9\*C3pC629 - k10/(1E6\*1E9)\*CiC4eC629\*C3pC629 =e= 0;  
 1487 EQU535..-r2C629 + k1/1E6\*C2C629\*CHXC629 + k11/(1E9\*1E6)\*C3pC629 \*C2C629 + k15/(1E12\*1E6)\*C8pC629\*C2C629 + k19/(1E14\*1E6)  
 \*C7pC629\*C2C629=e=0;  
 1488 EQU536..1000\*(FHC16\*x2HC16 - FAC42\*x2AC42) - r2C629\*VaC623\*MW2 =e= 0;  
 \_Economic Optimization Program 05/15/01 16:49:39 PAGE 34  
 GAMS 2.50A Windows NT/95/98

1489 EQU537..-r3C629 + r4C629 + r5C629 + r7C629 + r8C629 + r9C629 + r10C629 + riC10C629 + riC11C629 =e= 0;  
 1490 EQU538..k15/(1E6\*1E12)\*C8pC629\*C2C629 - k18/1E12\*CiC11pC629\*C3C629 - k17/1E12\*CiC11pC629 =e= 0;  
 1491 EQU539..k17/1E12\*CiC11pC629 - k4/1E14\*C7pC629\*C3C629 - k19/(1E6\*1E14)\*C7pC629\*C2C629 =e= 0;  
 1492 EQU540..FC316 \* x3C316 + FC329\*x3C329 - FC317 \* x3C317 - FC325\*x3C325 =e= 0;  
 1493 EQU541..FC316 \* x4C316 + FC329\*x4C329 - FC317 \* x4C317 - FC325\*x4C325 =e= 0;  
 1494 EQU542..FC316 \* x5C316 + FC329\*x5C329 - FC317 \* x5C317 - FC325\*x5C325 =e= 0;  
 1495 EQU543..x1C317 - x1C323 =e= 0;  
 1496 EQU544..x3C317 - x3C323 =e= 0;  
 1497 EQU545..x4C317 - x4C323 =e= 0;  
 1498 EQU546..x5C317 - x5C323 =e= 0;  
 1499 EQU547..FHC03 - FC419 - FC321 =e= 0;  
 1500 EQU548..FHC03 \* x1HC03 - FC419 \* x1C419 - FC321 \* x1C321 =e= 0;  
 1501 EQU549..FHC03 \* x3HC03 - FC419 \* x3C419 - FC321 \* x3C321 =e= 0;  
 1502 EQU550..FHC03 \* x4HC03 - FC419 \* x4C419 - FC321 \* x4C321 =e= 0;  
 1503 EQU551..FHC03 \* x5HC03 - FC419 \* x5C419 - FC321 \* x5C321 =e= 0;  
 1504 EQU552..hHC03 - hC419 - hC321 =e= 0;  
 1505 EQU553..FHC24 - FHC23 - FHC22 =e= 0;  
 1506 EQU554..FHC24\*x1HC24 - FHC23\*x1HC23 - FHC22\*x1HC22 =e= 0;  
 1507 EQU555..FHC24\*x3HC24 - FHC23\*x3HC23 - FHC22\*x3HC22 =e= 0;  
 1508 EQU556..FHC24\*x4HC24 - FHC23\*x4HC23 - FHC22\*x4HC22 =e= 0;  
 1509 EQU557..FHC24\*x5HC24 - FHC23\*x5HC23 - FHC22\*x5HC22 =e= 0;  
 1510 EQU558..FHC24\*x7HC24 - FHC23\*x7HC23 - FHC22\*x7HC22 =e= 0;  
 1511 EQU559..x1HC24+x2HC24+x3HC24+x4HC24+x5HC24+x7HC24 =e=1;  
 1512 EQU560..x1HC25+x2HC25+x3HC25+x4HC25+x5HC25+x7HC25 =e=1;  
 1513 EQU561..FHC26 - FHC25 - FHC24 =e= 0;  
 1514 EQU562..FHC26\*x1HC26 - FHC25\*x1HC25 - FHC24\*x1HC24 =e= 0;  
 1515 EQU563..FHC26\*x3HC26 - FHC25\*x3HC25 - FHC24\*x3HC24 =e= 0;  
 1516 EQU564..FHC26\*x4HC26 - FHC25\*x4HC25 - FHC24\*x4HC24 =e= 0;  
 1517 EQU565..FHC26\*x5HC26 - FHC25\*x5HC25 - FHC24\*x5HC24 =e= 0;  
 1518 EQU566..FHC26\*x7HC26 - FHC25\*x7HC25 - FHC24\*x7HC24 =e= 0;  
 1519 EQU567..x1HC26+x2HC26+x3HC26+x4HC26+x5HC26+x7HC26 =e=1;  
 1520 EQU568..x1HC27+x2HC27+x3HC27+x4HC27+x5HC27+x7HC27 =e=1;  
 1521 EQU569..FHC28 - FHC27 - FHC26 =e= 0;  
 1522 EQU570..FIHC28\*x1HC28 + FvHC28\*y1HC28 - FHC27\*x1HC27 - FHC26\*x1HC26 =e= 0;  
 1523 EQU571..FIHC28\*x3HC28 + FvHC28\*y3HC28 - FHC27\*x3HC27 - FHC26\*x3HC26 =e= 0;  
 1524 EQU572..FIHC28\*x4HC28 + FvHC28\*y4HC28 - FHC27\*x4HC27 - FHC26\*x4HC26 =e= 0;  
 1525 EQU573..FIHC28\*x5HC28 + FvHC28\*y5HC28 - FHC27\*x5HC27 - FHC26\*x5HC26 =e= 0;  
 1526 EQU574..FIHC28\*x7HC28 + FvHC28\*y7HC28 - FHC27\*x7HC27 - FHC26\*x7HC26 =e= 0;  
 1527 EQU575..x1HC28+x2HC28+x3HC28+x4HC28+x5HC28+x7HC28 =e=1;  
 1528 EQU576..FHC28 - FHC29 - FR1 =e= 0;  
 1529 EQU577..FR1 - FHC28\*sfS2 =e=0;  
 1530 EQU578..FIHC28 - FIHC29 - FIR1 =e= 0;  
 1531 EQU579..FvHC28 - FvHC29 - FvR1 =e= 0;  
 1532 EQU580..FIR1 - FIHC28\*sfS2 =e=0;  
 1533 EQU581..FvR1 - FvHC28\*sfS2 =e=0;  
 1534 EQU582..FHC15 - FHC14 - FHC16 =e= 0;  
 \_Economic Optimization Program 05/15/01 16:49:39 PAGE 35  
 GAMS 2.50A Windows NT/95/98

1535 EQU583..FHC15\*sfS11 - FHC14 =e= 0;  
 1536 EQU584..x1HC15 - x1HC14 =e= 0;  
 1537 EQU585..x2HC15 - x2HC16 =e= 0;  
 1538 EQU586..x2HC15 - x2HC14 =e= 0;  
 1539 EQU587..LpC606A=e=FC322 + qC606A\*FC404;  
 1540 EQU588..VpC606A=e=FC432;  
 1541 EQU589..TnC606A=e=(TC414+TC404)/2;  
 1542 EQU590..TmC606A=e=(TC430+TC404)/2;  
 1543 EQU591..FC418 \* x1C418 - FC417 \* x1C417 - FC415 \* x1C415 =e= 0;  
 1544 EQU592..FC418 \* x3C418 - FC417 \* x3C417 - FC415 \* x3C415 =e= 0;  
 1545 EQU593..FC418 \* x4C418 - FC417 \* x4C417 - FC415 \* x4C415 =e= 0;  
 1546 EQU594..FC418 \* x5C418 - FC417 \* x5C417 - FC415 \* x5C415 =e= 0;  
 1547 EQU595..hC418 - hC417 - hC415 =e= 0;  
 1548 EQU596..x4C405 - x4C406 =e= 0;  
 1549 EQU597..x5C405 - x5C406 =e= 0;  
 1550 EQU598..FC403 - FC404 =e= 0;  
 1551 EQU599..x1C403 - x1C404 =e= 0;  
 1552 EQU600..x3C403 - x3C404 =e= 0;  
 1553 EQU601..x4C403 - x4C404 =e= 0;  
 1554 EQU602..x5C403 - x5C404 =e= 0;  
 1555 EQU603..x3C406 - x3C407 =e= 0;  
 1556 EQU604..x4C406 - x4C407 =e= 0;  
 1557 EQU605..x5C406 - x5C407 =e= 0;  
 1558 EQU606..FC431 - FC412 - FC432 =e= 0;  
 1559 EQU607..FC432 - sfS41 \* FC431 =e= 0;  
 1560 EQU608..x1C431 - x1C412 =e= 0;  
 1561 EQU609..x3C431 - x3C412 =e= 0;  
 1562 EQU610..x4C431 - x4C412 =e= 0;  
 1563 EQU611..x5C431 - x5C412 =e= 0;  
 1564 EQU612..TC319 - TC320 =e= 0;  
 1565 EQU613..TC319 - TC321 =e= 0;  
 1566 EQU614..TC319 - TC322 =e= 0;  
 1567 EQU615..x1C431 - x1C432 =e= 0;  
 1568 EQU616..x3C431 - x3C432 =e= 0;



1569 EQU617..x4C431 - x4C432 =e= 0;  
 1570 EQU618..x5C431 - x5C432 =e= 0;  
 1571 EQU619..FC430 + FC427 - FC431 - FC425 =e= 0;  
 1572 EQU620..FC430 \* x1C430 + FC427 \* x3C427 - FC431 \* x1C431 - FC425 \* x1C425 =e= 0;  
 1573 EQU621..FC430 \* x3C430 + FC427 \* x3C427 - FC431 \* x3C431 - FC425 \* x3C425 =e= 0;  
 1574 EQU622..FC430 \* x4C430 + FC427 \* x4C427 - FC431 \* x4C431 - FC425 \* x4C425 =e= 0;  
 1575 EQU623..FC430 \* x5C430 + FC427 \* x5C427 - FC431 \* x5C431 - FC425 \* x5C425 =e= 0;  
 1576 EQU624..x3HC15 - x3HC14 =e= 0;  
 1577 EQU625..x4HC15 - x4HC14 =e= 0;  
 1578 EQU626..x5HC15 - x5HC14 =e= 0;  
 1579 EQU627..x3HC15 - x3HC16 =e= 0;  
 1580 EQU628..x4HC15 - x4HC16 =e= 0;  
 \_Economic Optimization Program

1581 EQU629..x5HC15 - x5HC16 =e= 0;  
 1582 EQU630..x1HC15 - x1HC16 =e= 0;  
 1583 EQU631..x1HC15 + x2HC15 + x3HC15 + x4HC15 + x5HC15 + x7HC15 =e= 1;  
 1584 EQU632..FHC08 - FHC11 - FHC15 =e= 0;  
 1585 EQU633..FHC08\*sfS7 - FHC11 =e= 0;  
 1586 EQU634..x1HC08 - x1HC11 =e= 0;  
 1587 EQU635..x2HC08 - x2HC11 =e= 0;  
 1588 EQU636..x3HC08 - x3HC11 =e= 0;  
 1589 EQU637..x4HC08 - x4HC11 =e= 0;  
 1590 EQU638..x5HC08 - x5HC11 =e= 0;  
 1591 EQU639..x1HC08 - x1HC15 =e= 0;  
 1592 EQU640..x2HC08 - x2HC15 =e= 0;  
 1593 EQU641..x3HC08 - x3HC15 =e= 0;  
 1594 EQU642..x4HC08 - x4HC15 =e= 0;  
 1595 EQU643..x5HC08 - x5HC15 =e= 0;  
 1596 EQU644..Q2HC11 - FHC11 \* x2HC11/(rho2HC11/1000) =e= 0;  
 1597 EQU645..QHC11 - FHC11/0.575 =e= 0;  
 1598 EQU646..x1HC11 + x2HC11 + x3HC11 + x4HC11 + x5HC11 + x7HC11 =e= 1;  
 1599 EQU647..FHC06 - FHC07 - FHC08 =e= 0;  
 1600 EQU648..FHC06\*sfS5 - FHC07 =e= 0;  
 1601 EQU649..x1HC06 - x1HC07 =e= 0;  
 1602 EQU650..FC425 - FC410 - FC426 =e= 0;  
 1603 EQU651..FC426 - sfS42 \* FC425 =e= 0;  
 1604 EQU652..x1C425 - x1C410 =e= 0;  
 1605 EQU653..x3C425 - x3C410 =e= 0;  
 1606 EQU654..x4C425 - x4C410 =e= 0;  
 1607 EQU655..x5C425 - x5C410 =e= 0;  
 1608 EQU656..x1C425 - x1C426 =e= 0;  
 1609 EQU657..x3C425 - x3C426 =e= 0;  
 1610 EQU658..x4C425 - x4C426 =e= 0;  
 1611 EQU659..x5C425 - x5C426 =e= 0;  
 1612 EQU660..x1C410 - x1C411 =e= 0;  
 1613 EQU661..x3C410 - x3C411 =e= 0;  
 1614 EQU662..x4C410 - x4C411 =e= 0;  
 1615 EQU663..x5C410 - x5C411 =e= 0;  
 1616 EQU664..hc427 - hc428 - hc411 =e= 0;  
 1617 EQU665..FC427 \* x1C427 - FC428 \* x1C428 - FC411 \* x1C411 =e= 0;  
 1618 EQU666..FC427 \* x3C427 - FC428 \* x3C428 - FC411 \* x3C411 =e= 0;  
 1619 EQU667..FC427 \* x4C427 - FC428 \* x4C428 - FC411 \* x4C411 =e= 0;  
 1620 EQU668..FC427 \* x5C427 - FC428 \* x5C428 - FC411 \* x5C411 =e= 0;  
 1621 EQU669..FC426 - FC428 - FC405 =e= 0;  
 1622 EQU670..x2HC06 - x2HC07 =e= 0;  
 1623 EQU671..x3HC06 - x3HC07 =e= 0;  
 1624 EQU672..x4HC06 - x4HC07 =e= 0;  
 1625 EQU673..x5HC06 - x5HC07 =e= 0;  
 1626 EQU674..x1HC06 - x1HC08 =e= 0;  
 \_Economic Optimization Program

1627 EQU675..x2HC06 - x2HC08 =e= 0;  
 1628 EQU676..x3HC06 - x3HC08 =e= 0;  
 1629 EQU677..x4HC06 - x4HC08 =e= 0;  
 1630 EQU678..x5HC06 - x5HC08 =e= 0;  
 1631 EQU679..x1HC07 + x2HC07 + x3HC07 + x4HC07 + x5HC07 + x7HC07 =e= 1;  
 1632 EQU680..QHC07 - FHC07/0.575 =e= 0;  
 1633 EQU681..Q2HC07 - FHC07 \* x2HC07/(rho2HC07/1000) =e= 0;  
 1634 EQU682..x1HC06 + x2HC06 + x3HC06 + x4HC06 + x5HC06 + x7HC06 =e= 1;  
 1635 EQU683..FHC06 - FHC02 - FHC05 =e= 0;  
 1636 EQU684..FHC06\*x1HC06 - FHC02\*x1HC02 - FHC05\*x1HC05 =e= 0;  
 1637 EQU685..FHC06\*x2HC06 - FHC02\*x2HC02 - FHC05\*x2HC05 =e= 0;  
 1638 EQU686..FHC06\*x3HC06 - FHC02\*x3HC02 - FHC05\*x3HC05 =e= 0;  
 1639 EQU687..FHC06\*x4HC06 - FHC02\*x4HC02 - FHC05\*x4HC05 =e= 0;  
 1640 EQU688..FHC06\*x5HC06 - FHC02\*x5HC02 - FHC05\*x5HC05 =e= 0;  
 1641 EQU689..FHC40 - FHC41 - FHC45 =e= 0;  
 1642 EQU690..FHC40\*sfS27 - FHC41 =e= 0;  
 1643 EQU691..x1HC40 - x1HC41 =e= 0;  
 1644 EQU692..x3HC40 - x3HC41 =e= 0;  
 1645 EQU693..x4HC40 - x4HC41 =e= 0;  
 1646 EQU694..x5HC40 - x5HC41 =e= 0;  
 1647 EQU695..x1HC40 - x1HC45 =e= 0;  
 1648 EQU696..x3HC40 - x3HC45 =e= 0;  
 1649 EQU697..x4HC40 - x4HC45 =e= 0;  
 1650 EQU698..x1HC32 - x1HC33 =e= 0;  
 1651 EQU699..FC426 \* x1C426 - FC428 \* x1C428 - FC405 \* x1C405 =e= 0;  
 1652 EQU700..FC426 \* x3C426 - FC428 \* x3C428 - FC405 \* x3C405 =e= 0;

1653 EQU701..FC426 \* x4C426- FC428 \* x4C428 - FC405 \* x4C405 =e= 0;  
 1654 EQU702..FC426 \* x5C426- FC428 \* x5C428 - FC405 \* x5C405 =e= 0;  
 1655 EQU703..FC408 - FC409 =e= 0;  
 1656 EQU704..x1C408 - x1C409 =e= 0;  
 1657 EQU705..x3C408 - x3C409 =e= 0;  
 1658 EQU706..x4C408 - x4C409 =e= 0;  
 1659 EQU707..x5C408 - x5C409 =e= 0;  
 1660 EQU708..x5HC40 - x5HC45 =e= 0;  
 1661 EQU709..FHC32 - FHC33 - FHC40 =e= 0;  
 1662 EQU710..x1HC45 +x3HC45 + x4HC45 + x5HC45 + x7HC45 =e= 1;  
 1663 EQU711..QHC45 - FHC45/0.575 =e= 0;  
 1664 EQU712..x1HC40 +x3HC40 + x4HC40 + x5HC40 + x7HC40 =e= 1;  
 1665 EQU713..FHC32\*sfS19 - FHC33 =e= 0;  
 1666 EQU714..x3HC32 - x3HC33 =e= 0;  
 1667 EQU715..x4HC32 - x4HC33 =e= 0;  
 1668 EQU716..x5HC32 - x5HC33 =e= 0;  
 1669 EQU717..x1HC32 - x1HC40 =e= 0;  
 1670 EQU718..x3HC32 - x3HC40 =e= 0;  
 1671 EQU719..x4HC32 - x4HC40 =e= 0;  
 1672 EQU720..x5HC32 - x5HC40 =e= 0;  
 \_Economic Optimization Program

1673 EQU721..x1HC33 +x3HC33 + x4HC33 + x5HC33 + x7HC33 =e= 1;  
 1674 EQU722..FHC33 - FHC34 - FHC38 =e= 0;  
 1675 EQU723..FHC33\*sfS23 - FHC34 =e= 0;  
 1676 EQU724..x1HC33 - x1HC34 =e= 0;  
 1677 EQU725..x3HC33 - x3HC34 =e= 0;  
 1678 EQU726..x4HC33 - x4HC34 =e= 0;  
 1679 EQU727..x5HC33 - x5HC34 =e= 0;  
 1680 EQU728..x1HC33 - x1HC38 =e= 0;  
 1681 EQU729..x3HC33 - x3HC38 =e= 0;  
 1682 EQU730..x4HC33 - x4HC38 =e= 0;  
 1683 EQU731..x5HC33 - x5HC38 =e= 0;  
 1684 EQU732..x1HC34 +x3HC34 + x4HC34 + x5HC34 + x7HC34 =e= 1;  
 1685 EQU733..QHC34 - FHC34/0.575 =e= 0;  
 1686 EQU734..QHC38 - FHC38/0.575 =e= 0;  
 1687 EQU735..x1HC38 +x3HC38 + x4HC38 + x5HC38 + x7HC38 =e= 1;  
 1688 EQU736..FC412 - FC413 =e= 0;  
 1689 EQU737..x1C412 - x1C413 =e= 0;  
 1690 EQU738..x3C412 - x3C413 =e= 0;  
 1691 EQU739..x4C412 - x4C413 =e= 0;  
 1692 EQU740..x5C412 - x5C413 =e= 0;  
 1693 EQU741..x1C319 - x1C322 =e= 0;  
 1694 EQU742..x3C319 - x3C322 =e= 0;  
 1695 EQU743..x4C319 - x4C322 =e= 0;  
 1696 EQU744..x5C319 - x5C322 =e= 0;  
 1697 EQU745..hC414liq - FC414 \* ((x1C414/MW1)\*(SUM(Coeff,1/ORD(Coeff) \* Enth\_liq("1",Coeff) \*POWER(TC414,ORD(Coeff))))  
 1698 +(x3C414/MW3)\*(SUM(Coeff,1/ORD(Coeff) \* Enth\_liq("3",Coeff) \* POWER(TC414,ORD(Coeff))))  
 1699 +(x4C414/MW4)\*(SUM(Coeff,1/ORD(Coeff) \* Enth\_liq("4",Coeff) \* POWER(TC414,ORD(Coeff))))  
 1700 +(x5C414/MW5)\*(SUM(Coeff,1/ORD(Coeff) \* Enth\_liq("5",Coeff) \* POWER(TC414,ORD(Coeff))))  
 1701 +(x7C414/MW7)\*(SUM(Coeff,1/ORD(Coeff) \* Enth\_liq("7",Coeff) \* POWER(TC414,ORD(Coeff)))) =e= 0;  
 1702 EQU746..dTE621A\*2 =e=  
 1703 (TC414-TcwotE621A) + (TC414-Tcwin);  
 1704 EQU747..(hC414liq - hC415) - FcwE621B\*4.197\*(TcwotE621B - Tcwin) =e= 0;  
 1705 EQU748..(hC414liq - hC415) - UE621B\*FE621B\*AE621B\*dTE621B =e= 0;  
 1706 EQU749..dTE621B\*\*3 =e= ((TC414-TcwotE621B)\*(TC415-Tcwin)\*  
 1707 ((TC414-TcwotE621B)+(TC415-Tcwin))/2);  
 1708 EQU750..hC412liq - FC412 \* ((x1C412/MW1)\*(SUM(Coeff,1/ORD(Coeff) \* Enth\_liq("1",Coeff) \*POWER(TC412,ORD(Coeff))))  
 1709 +(x3C412/MW3)\*(SUM(Coeff,1/ORD(Coeff) \* Enth\_liq("3",Coeff) \* POWER(TC412,ORD(Coeff))))  
 1710 +(x4C412/MW4)\*(SUM(Coeff,1/ORD(Coeff) \* Enth\_liq("4",Coeff) \* POWER(TC412,ORD(Coeff))))  
 1711 +(x5C412/MW5)\*(SUM(Coeff,1/ORD(Coeff) \* Enth\_liq("5",Coeff) \* POWER(TC412,ORD(Coeff))))  
 1712 +(x7C412/MW7)\*(SUM(Coeff,1/ORD(Coeff) \* Enth\_liq("7",Coeff) \* POWER(TC412,ORD(Coeff)))) =e= 0;  
 1713 EQU751..dTE627A\*2 =e=  
 1714 (TC412-TcwotE627A) + (TC412-Tcwin);  
 1715 EQU752..(hC412liq - hC413) - FcwE627B\*4.197\*(TcwotE627B - Tcwin) =e= 0;  
 1716 EQU753..(hC412liq - hC413) - UE627B\*FE627B\*AE627B\*dTE627B =e= 0;  
 1717 EQU754..dTE627B\*\*3 =e= ((TC412-TcwotE627B)\*(TC413-Tcwin)\*  
 1718 ((TC412-TcwotE627B)+(TC413-Tcwin))/2);  
 \_Economic Optimization Program

1719 EQU755..hC411 - FC411 \*  
 1720 ((x1C411/MW1)\*(SUM(Coeff,1/ORD(Coeff) \* Enth\_liq("1",Coeff) \*POWER(TC411,ORD(Coeff))))  
 1721 +(x3C411/MW3)\*(SUM(Coeff,1/ORD(Coeff) \* Enth\_liq("3",Coeff) \* POWER(TC411,ORD(Coeff))))  
 1722 +(x4C411/MW4)\*(SUM(Coeff,1/ORD(Coeff) \* Enth\_liq("4",Coeff) \* POWER(TC411,ORD(Coeff))))+ Enth\_Vap("4","a1")\*1000 \*  
 ((1-TC411/Enth\_Vap("4","a2"))\*\*Enth\_Vap("4","a3"))  
 1723 +(x5C411/MW5)\*(SUM(Coeff,1/ORD(Coeff) \* Enth\_liq("5",Coeff) \* POWER(TC411,ORD(Coeff))))+ Enth\_Vap("5","a1")\*1000 \*  
 ((1-TC411/Enth\_Vap("5","a2"))\*\*Enth\_Vap("5","a3"))  
 1724 +(x7C411/MW7)\*(SUM(Coeff,1/ORD(Coeff) \* Enth\_liq("7",Coeff) \* POWER(TC411,ORD(Coeff))))+ Enth\_Vap("7","a1")\*1000 \*  
 ((1-TC411/Enth\_Vap("7","a2"))\*\*Enth\_Vap("7","a3")) =e= 0;  
 1725 EQU756..hC410vap - FC410 \*  
 1726 ((x1C410/MW1)\*(SUM(Coeff,1/ORD(Coeff) \* Enth\_liq("1",Coeff) \*POWER(TC410,ORD(Coeff))))+ Enth\_Vap("1","a1")\*1000 \*  
 ((1-TC410/Enth\_Vap("1","a2"))\*\*Enth\_Vap("1","a3"))  
 1727 +(x3C410/MW3)\*(SUM(Coeff,1/ORD(Coeff) \* Enth\_liq("3",Coeff) \* POWER(TC410,ORD(Coeff))))+ Enth\_Vap("3","a1")\*1000 \*  
 ((1-TC410/Enth\_Vap("3","a2"))\*\*Enth\_Vap("3","a3"))  
 1728 +(x4C410/MW4)\*(SUM(Coeff,1/ORD(Coeff) \* Enth\_liq("4",Coeff) \* POWER(TC410,ORD(Coeff))))+ Enth\_Vap("4","a1")\*1000 \*  
 ((1-TC410/Enth\_Vap("4","a2"))\*\*Enth\_Vap("4","a3"))  
 1729 +(x5C410/MW5)\*(SUM(Coeff,1/ORD(Coeff) \* Enth\_liq("5",Coeff) \* POWER(TC410,ORD(Coeff))))+ Enth\_Vap("5","a1")\*1000 \*  
 ((1-TC410/Enth\_Vap("5","a2"))\*\*Enth\_Vap("5","a3"))

```

1730 +(x7C410/MW7)*(SUM(Coeff,1/ORD(Coeff))*Enth_liq("7",Coeff)*POWER(TC410,ORD(Coeff))+Enth_Vap("7","a1")*1000*
((1-TC410/Enth_Vap("7","a2"))**Enth_Vap("7","a3")))=e=0;
1731 EQU757..dTE696A =e= 414.6 - TC410;
1732 EQU758..(hC411 - hC410vap) - FstmE696B * hstmE696 =e= 0;
1733 EQU759..(hC411 - hC410vap) - UE696B*AE696B*dTE696B =e= 0;
1734 EQU760..dTE696B*2 =e=
1735 (414.6-TC410) + (414.6-TC411);
1736 EQU761..dTE626**3 =e= ((TC418-TcwoutE626)*(TC419-Tcwin)*
1737 ((TC418-TcwoutE626)+(TC419-Tcwin))/2);
1738 EQU762..dTE617 **3=e= ((TC406-TcwoutE617)*(TC407-Tcwin)*
1739 ((TC406-TcwoutE617)+(TC407-Tcwin))/2);
1740 EQU763..dTE616**3 =e= ((TC405-TC404)*(TC406-TC403)*
1741 ((TC405-TC404)+(TC406-TC403))/2);
1742 EQU764..hC408vap - FC408 *
1743 ((x1C408/MW1)*(SUM(Coeff,1/ORD(Coeff))*Enth_liq("1",Coeff)*POWER(TC408,ORD(Coeff)))
1744 )
1745 +(x3C408/MW3)*(SUM(Coeff,1/ORD(Coeff))*Enth_liq("3",Coeff)*POWER(TC408,ORD(Coeff)))
1746 +(x4C408/MW4)*(SUM(Coeff,1/ORD(Coeff))*Enth_liq("4",Coeff)*POWER(TC408,ORD(Coeff)))
1747 +(x5C408/MW5)*(SUM(Coeff,1/ORD(Coeff))*Enth_liq("5",Coeff)*POWER(TC408,ORD(Coeff))+Enth_Vap("5","a1")*1000*
((1-TC408/Enth_Vap("5","a2"))**Enth_Vap("5","a3")))
1748 +(x7C408/MW7)*(SUM(Coeff,1/ORD(Coeff))*Enth_liq("7",Coeff)*POWER(TC408,ORD(Coeff))+Enth_Vap("7","a1")*1000*
((1-TC408/Enth_Vap("7","a2"))**Enth_Vap("7","a3"))) =e= 0;
1749 EQU765..dTE695A =e= 481 - TC408;
1750 EQU766..(hC409 - hC408vap) - FstmE695B * hstmE695 =e= 0;
1751 EQU767..(hC409 - hC408vap) - UE695B*AE695B*dTE695B =e= 0;
1752 EQU768..dTE695B*2 =e=
1753 (481-TC408) + (481-TC409);
1754 EQU769..hvR1 - FvR1*(y1R1/MW1)*(SUM(Coeff,1/ORD(Coeff))*Enth_liq("1",Coeff)*POWER(TR1,ORD(Coeff))+Enth_Vap("1","a1")
_Economic Optimization Program
05/15/01 16:49:39 PAGE 40
GAMS 2.50A Windows NT/95/98

```

```

*1000*((1-TR1/Enth_Vap("1","a2"))**Enth_Vap("1","a3"))
1755 +(y3R1/MW3)*(SUM(Coeff,1/ORD(Coeff))*Enth_liq("3",Coeff)*POWER(TR1,ORD(Coeff))+Enth_Vap("3","a1")*1000*((1-TR1/Enth_Vap(
"3","a2"))**Enth_Vap("3","a3")))
1756 +(y4R1/MW4)*(SUM(Coeff,1/ORD(Coeff))*Enth_liq("4",Coeff)*POWER(TR1,ORD(Coeff))+Enth_Vap("4","a1")*1000*((1-TR1/Enth_Vap("
4","a2"))**Enth_Vap("4","a3")))
1757 +(y5R1/MW5)*(SUM(Coeff,1/ORD(Coeff))*Enth_liq("5",Coeff)*POWER(TR1,ORD(Coeff))+Enth_Vap("5","a1")*1000*((1-TR1/Enth_Vap("
5","a2"))**Enth_Vap("5","a3")))
1758 +(y7R1/MW7)*(SUM(Coeff,1/ORD(Coeff))*Enth_liq("7",Coeff)*POWER(TR1,ORD(Coeff))+Enth_Vap("7","a1")*1000*((1-TR1/Enth_Vap("
7","a2"))**Enth_Vap("7","a3"))) =e= 0;
1759 EQU770..y1R1 + y2R1 + y3R1 + y4R1 + y5R1 + y7R1 =e= 1;
1760 EQU771..h1R1 - FIR1*((x1R1/MW1)*(SUM(Coeff,1/ORD(Coeff))*Enth_liq("1",Coeff)*POWER(TR1,ORD(Coeff)))
1761 +(x3R1/MW3)*(SUM(Coeff,1/ORD(Coeff))*Enth_liq("3",Coeff)*POWER(TR1,ORD(Coeff)))
1762 +(x4R1/MW4)*(SUM(Coeff,1/ORD(Coeff))*Enth_liq("4",Coeff)*POWER(TR1,ORD(Coeff)))
1763 +(x5R1/MW5)*(SUM(Coeff,1/ORD(Coeff))*Enth_liq("5",Coeff)*POWER(TR1,ORD(Coeff)))
1764 +(x7R1/MW7)*(SUM(Coeff,1/ORD(Coeff))*Enth_liq("7",Coeff)*POWER(TR1,ORD(Coeff)))) =e= 0;
1765 EQU772..x1R1 + x2R1 + x3R1 + x4R1 + x5R1 + x7R1 =e= 1;
1766 EQU773..h1R1 - h1R1 - hvR1 =e= 0;
1767 EQU774..hvHC29 - FvHC29*((y1HC29/MW1)*(SUM(Coeff,1/ORD(Coeff))*Enth_liq("1",Coeff)*POWER(THC29,ORD(Coeff))+Enth_Vap("1",
"a1")*1000*((1-THC29/Enth_Vap("1","a2"))**Enth_Vap("1","a3")))
1768 +(y3HC29/MW3)*(SUM(Coeff,1/ORD(Coeff))*Enth_liq("3",Coeff)*POWER(THC29,ORD(Coeff))+Enth_Vap("3","a1")*1000*
((1-THC29/Enth_Vap("3","a2"))**Enth_Vap("3","a3")))
1769 +(y4HC29/MW4)*(SUM(Coeff,1/ORD(Coeff))*Enth_liq("4",Coeff)*POWER(THC29,ORD(Coeff))+Enth_Vap("4","a1")*1000*
((1-THC29/Enth_Vap("4","a2"))**Enth_Vap("4","a3")))
1770 +(y5HC29/MW5)*(SUM(Coeff,1/ORD(Coeff))*Enth_liq("5",Coeff)*POWER(THC29,ORD(Coeff))+Enth_Vap("5","a1")*1000*
((1-THC29/Enth_Vap("5","a2"))**Enth_Vap("5","a3")))
1771 +(y7HC29/MW7)*(SUM(Coeff,1/ORD(Coeff))*Enth_liq("7",Coeff)*POWER(THC29,ORD(Coeff))+Enth_Vap("7","a1")*1000*
((1-THC29/Enth_Vap("7","a2"))**Enth_Vap("7","a3"))) =e= 0;
1772 EQU775..hHC29 - h1HC29 - hvHC29 =e= 0;
1773 EQU776..FHC29 - F1HC29 - FvHC29 =e= 0;
1774 EQU777..h1HC29 - F1HC29*((x1HC29/MW1)*(SUM(Coeff,1/ORD(Coeff))*Enth_liq("1",Coeff)*POWER(THC29,ORD(Coeff)))
1775 +(x3HC29/MW3)*(SUM(Coeff,1/ORD(Coeff))*Enth_liq("3",Coeff)*POWER(THC29,ORD(Coeff)))
1776 +(x4HC29/MW4)*(SUM(Coeff,1/ORD(Coeff))*Enth_liq("4",Coeff)*POWER(THC29,ORD(Coeff)))
1777 +(x5HC29/MW5)*(SUM(Coeff,1/ORD(Coeff))*Enth_liq("5",Coeff)*POWER(THC29,ORD(Coeff)))
1778 +(x7HC29/MW7)*(SUM(Coeff,1/ORD(Coeff))*Enth_liq("7",Coeff)*POWER(THC29,ORD(Coeff)))) =e= 0;
1779 EQU778..xx7HC32 * MW7 * FmHC32 - FHC32 * x7HC32 =e= 0;
1780 EQU779..xx5HC32 * MW5 * FmHC32 - FHC32 * x5HC32 =e= 0;
1781 EQU780..FR1 - FIR1 - FvR1 =e= 0;
1782 EQU781..hC303 - FC303 *
1783 ((x1C303/MW1)*(SUM(Coeff,1/ORD(Coeff))*Enth_liq("1",Coeff)*POWER(TC303,ORD(Coeff))+Enth_Vap("1","a1")*1000*
((1-TC303/Enth_Vap("1","a2"))**Enth_Vap("1","a3")))
1784 +(x3C303/MW3)*(SUM(Coeff,1/ORD(Coeff))*Enth_liq("3",Coeff)*POWER(TC303,ORD(Coeff))+Enth_Vap("3","a1")*1000*
((1-TC303/Enth_Vap("3","a2"))**Enth_Vap("3","a3")))
1785 +(x4C303/MW4)*(SUM(Coeff,1/ORD(Coeff))*Enth_liq("4",Coeff)*POWER(TC303,ORD(Coeff))+Enth_Vap("4","a1")*1000*
((1-TC303/Enth_Vap("4","a2"))**Enth_Vap("4","a3")))
1786 +(x5C303/MW5)*(SUM(Coeff,1/ORD(Coeff))*Enth_liq("5",Coeff)*POWER(TC303,ORD(Coeff))+Enth_Vap("5","a1")*1000*
((1-TC303/Enth_Vap("5","a2"))**Enth_Vap("5","a3")))
_Economic Optimization Program
05/15/01 16:49:39 PAGE 41
GAMS 2.50A Windows NT/95/98

```

```

1787 +(x7C303/MW7)*(SUM(Coeff,1/ORD(Coeff))*Enth_liq("7",Coeff)*POWER(TC303,ORD(Coeff))+Enth_Vap("7","a1")*1000*
((1-TC303/Enth_Vap("7","a2"))**Enth_Vap("7","a3"))) =e= 0;
1788 EQU782..hC306 - FC306 *
1789 ((x1C306/MW1)*(SUM(Coeff,1/ORD(Coeff))*Enth_liq("1",Coeff)*POWER(TC306,ORD(Coeff))+Enth_Vap("1","a1")*1000*
((1-TC306/Enth_Vap("1","a2"))**Enth_Vap("1","a3")))
1790 +(x3C306/MW3)*(SUM(Coeff,1/ORD(Coeff))*Enth_liq("3",Coeff)*POWER(TC306,ORD(Coeff))+Enth_Vap("3","a1")*1000*
((1-TC306/Enth_Vap("3","a2"))**Enth_Vap("3","a3")))
1791 +(x4C306/MW4)*(SUM(Coeff,1/ORD(Coeff))*Enth_liq("4",Coeff)*POWER(TC306,ORD(Coeff))+Enth_Vap("4","a1")*1000*
((1-TC306/Enth_Vap("4","a2"))**Enth_Vap("4","a3")))
1792 +(x5C306/MW5)*(SUM(Coeff,1/ORD(Coeff))*Enth_liq("5",Coeff)*POWER(TC306,ORD(Coeff))+Enth_Vap("5","a1")*1000*

```

```

((1-TC306/Enth_Vap("5","a2"))**Enth_Vap("5","a3"))
1793 +(x7C306/MW7)*(SUM(Coeff,1/ORD(Coeff)* Enth_liq("7",Coeff) *POWER(TC306,ORD(Coeff)))+ Enth_Vap("7","a1")*1000 *
((1-TC306/Enth_Vap("7","a2"))**Enth_Vap("7","a3"))) =e= 0;
1794 EQU783..hC308 - FC308 * ((x1C308/MW1)*(SUM(Coeff,1/ORD(Coeff)* Enth_liq("1",Coeff) *POWER(TC308,ORD(Coeff))))
1795 +(x3C308/MW3)*(SUM(Coeff,1/ORD(Coeff)* Enth_liq("3",Coeff) * POWER(TC308,ORD(Coeff))))
1796 +(x4C308/MW4)*(SUM(Coeff,1/ORD(Coeff)* Enth_liq("4",Coeff) *POWER(TC308,ORD(Coeff))))
1797 +(x5C308/MW5)*(SUM(Coeff,1/ORD(Coeff)* Enth_liq("5",Coeff) *POWER(TC308,ORD(Coeff))))
1798 +(x7C308/MW7)*(SUM(Coeff,1/ORD(Coeff)* Enth_liq("7",Coeff) *POWER(TC308,ORD(Coeff)))) =e= 0;
1799 EQU784..hC310 - FC310 *
1800 ((x1C310/MW1)*(SUM(Coeff,1/ORD(Coeff)* Enth_liq("1",Coeff) *POWER(TC310,ORD(Coeff)))+ Enth_Vap("1","a1")*1000 *
((1-TC310/Enth_Vap("1","a2"))**Enth_Vap("1","a3")))
1801 +(x3C310/MW3)*(SUM(Coeff,1/ORD(Coeff)* Enth_liq("3",Coeff) * POWER(TC310,ORD(Coeff)))+ Enth_Vap("3","a1")*1000 *
((1-TC310/Enth_Vap("3","a2"))**Enth_Vap("3","a3")))
1802 +(x4C310/MW4)*(SUM(Coeff,1/ORD(Coeff)* Enth_liq("4",Coeff) *POWER(TC310,ORD(Coeff)))+ Enth_Vap("4","a1")*1000 *
((1-TC310/Enth_Vap("4","a2"))**Enth_Vap("4","a3")))
1803 +(x5C310/MW5)*(SUM(Coeff,1/ORD(Coeff)* Enth_liq("5",Coeff) *POWER(TC310,ORD(Coeff)))+ Enth_Vap("5","a1")*1000 *
((1-TC310/Enth_Vap("5","a2"))**Enth_Vap("5","a3")))
1804 +(x7C310/MW7)*(SUM(Coeff,1/ORD(Coeff)* Enth_liq("7",Coeff) *POWER(TC310,ORD(Coeff)))+ Enth_Vap("7","a1")*1000 *
((1-TC310/Enth_Vap("7","a2"))**Enth_Vap("7","a3"))) =e= 0;
1805 EQU785..hC311 - FC311 * ((x1C311/MW1)*(SUM(Coeff,1/ORD(Coeff)* Enth_liq("1",Coeff) *POWER(TC311,ORD(Coeff))))
1806 +(x3C311/MW3)*(SUM(Coeff,1/ORD(Coeff)* Enth_liq("3",Coeff) * POWER(TC311,ORD(Coeff))))
1807 +(x4C311/MW4)*(SUM(Coeff,1/ORD(Coeff)* Enth_liq("4",Coeff) *POWER(TC311,ORD(Coeff))))
1808 +(x5C311/MW5)*(SUM(Coeff,1/ORD(Coeff)* Enth_liq("5",Coeff) *POWER(TC311,ORD(Coeff))))
1809 +(x7C311/MW7)*(SUM(Coeff,1/ORD(Coeff)* Enth_liq("7",Coeff) *POWER(TC311,ORD(Coeff)))) =e= 0;
1810 EQU786..hC312 - FC312 *
1811 ((x1C312/MW1)*(SUM(Coeff,1/ORD(Coeff)* Enth_liq("1",Coeff) *POWER(TC312,ORD(Coeff)))+ Enth_Vap("1","a1")*1000 *
((1-TC312/Enth_Vap("1","a2"))**Enth_Vap("1","a3")))
1812 +(x3C312/MW3)*(SUM(Coeff,1/ORD(Coeff)* Enth_liq("3",Coeff) * POWER(TC312,ORD(Coeff)))+ Enth_Vap("3","a1")*1000 *
((1-TC312/Enth_Vap("3","a2"))**Enth_Vap("3","a3")))
1813 +(x4C312/MW4)*(SUM(Coeff,1/ORD(Coeff)* Enth_liq("4",Coeff) *POWER(TC312,ORD(Coeff)))+ Enth_Vap("4","a1")*1000 *
((1-TC312/Enth_Vap("4","a2"))**Enth_Vap("4","a3")))
1814 +(x5C312/MW5)*(SUM(Coeff,1/ORD(Coeff)* Enth_liq("5",Coeff) *POWER(TC312,ORD(Coeff)))+ Enth_Vap("5","a1")*1000 *
((1-TC312/Enth_Vap("5","a2"))**Enth_Vap("5","a3")))
1815 +(x7C312/MW7)*(SUM(Coeff,1/ORD(Coeff)* Enth_liq("7",Coeff) *POWER(TC312,ORD(Coeff)))+ Enth_Vap("7","a1")*1000 *
((1-TC312/Enth_Vap("7","a2"))**Enth_Vap("7","a3"))) =e= 0;
1816 EQU787..hC315 - FC315 * ((x1C315/MW1)*(SUM(Coeff,1/ORD(Coeff)* Enth_liq("1",Coeff) *POWER(TC315,ORD(Coeff))))
_Economic Optimization Program
05/15/01 16:49:39 PAGE 42

```

GAMS 2.50A Windows NT/95/98

```

1817 +(x3C315/MW3)*(SUM(Coeff,1/ORD(Coeff)* Enth_liq("3",Coeff) * POWER(TC315,ORD(Coeff))))
1818 +(x4C315/MW4)*(SUM(Coeff,1/ORD(Coeff)* Enth_liq("4",Coeff) *POWER(TC315,ORD(Coeff))))
1819 +(x5C315/MW5)*(SUM(Coeff,1/ORD(Coeff)* Enth_liq("5",Coeff) *POWER(TC315,ORD(Coeff))))
1820 +(x7C315/MW7)*(SUM(Coeff,1/ORD(Coeff)* Enth_liq("7",Coeff) *POWER(TC315,ORD(Coeff)))) =e= 0;
1821 EQU788..hC316 - FC316 * ((x1C316/MW1)*(SUM(Coeff,1/ORD(Coeff)* Enth_liq("1",Coeff) *POWER(TC316,ORD(Coeff))))
1822 +(x3C316/MW3)*(SUM(Coeff,1/ORD(Coeff)* Enth_liq("3",Coeff) * POWER(TC316,ORD(Coeff))))
1823 +(x4C316/MW4)*(SUM(Coeff,1/ORD(Coeff)* Enth_liq("4",Coeff) *POWER(TC316,ORD(Coeff))))
1824 +(x5C316/MW5)*(SUM(Coeff,1/ORD(Coeff)* Enth_liq("5",Coeff) *POWER(TC316,ORD(Coeff))))
1825 +(x7C316/MW7)*(SUM(Coeff,1/ORD(Coeff)* Enth_liq("7",Coeff) *POWER(TC316,ORD(Coeff)))) =e= 0;
1826 EQU789..hC317 - FC317 * ((x1C317/MW1)*(SUM(Coeff,1/ORD(Coeff)* Enth_liq("1",Coeff) *POWER(TC317,ORD(Coeff))))
1827 +(x3C317/MW3)*(SUM(Coeff,1/ORD(Coeff)* Enth_liq("3",Coeff) * POWER(TC317,ORD(Coeff))))
1828 +(x4C317/MW4)*(SUM(Coeff,1/ORD(Coeff)* Enth_liq("4",Coeff) *POWER(TC317,ORD(Coeff))))
1829 +(x5C317/MW5)*(SUM(Coeff,1/ORD(Coeff)* Enth_liq("5",Coeff) *POWER(TC317,ORD(Coeff))))
1830 +(x7C317/MW7)*(SUM(Coeff,1/ORD(Coeff)* Enth_liq("7",Coeff) *POWER(TC317,ORD(Coeff)))) =e= 0;
1831 EQU790..hC318 - FC318 * ((x1C318/MW1)*(SUM(Coeff,1/ORD(Coeff)* Enth_liq("1",Coeff) *POWER(TC318,ORD(Coeff))))
1832 +(x3C318/MW3)*(SUM(Coeff,1/ORD(Coeff)* Enth_liq("3",Coeff) * POWER(TC318,ORD(Coeff))))
1833 +(x4C318/MW4)*(SUM(Coeff,1/ORD(Coeff)* Enth_liq("4",Coeff) *POWER(TC318,ORD(Coeff))))
1834 +(x5C318/MW5)*(SUM(Coeff,1/ORD(Coeff)* Enth_liq("5",Coeff) *POWER(TC318,ORD(Coeff))))
1835 +(x7C318/MW7)*(SUM(Coeff,1/ORD(Coeff)* Enth_liq("7",Coeff) *POWER(TC318,ORD(Coeff)))) =e= 0;
1836 EQU791..hC319 - FC319 * ((x1C319/MW1)*(SUM(Coeff,1/ORD(Coeff)* Enth_liq("1",Coeff) *POWER(TC319,ORD(Coeff))))
1837 +(x3C319/MW3)*(SUM(Coeff,1/ORD(Coeff)* Enth_liq("3",Coeff) * POWER(TC319,ORD(Coeff))))
1838 +(x4C319/MW4)*(SUM(Coeff,1/ORD(Coeff)* Enth_liq("4",Coeff) *POWER(TC319,ORD(Coeff))))
1839 +(x5C319/MW5)*(SUM(Coeff,1/ORD(Coeff)* Enth_liq("5",Coeff) *POWER(TC319,ORD(Coeff))))
1840 +(x7C319/MW7)*(SUM(Coeff,1/ORD(Coeff)* Enth_liq("7",Coeff) *POWER(TC319,ORD(Coeff)))) =e= 0;
1841 EQU792..hC403 - FC403 * ((x1C403/MW1)*(SUM(Coeff,1/ORD(Coeff)* Enth_liq("1",Coeff) *POWER(TC403,ORD(Coeff))))
1842 +(x3C403/MW3)*(SUM(Coeff,1/ORD(Coeff)* Enth_liq("3",Coeff) * POWER(TC403,ORD(Coeff))))
1843 +(x4C403/MW4)*(SUM(Coeff,1/ORD(Coeff)* Enth_liq("4",Coeff) *POWER(TC403,ORD(Coeff))))
1844 +(x5C403/MW5)*(SUM(Coeff,1/ORD(Coeff)* Enth_liq("5",Coeff) *POWER(TC403,ORD(Coeff))))
1845 +(x7C403/MW7)*(SUM(Coeff,1/ORD(Coeff)* Enth_liq("7",Coeff) *POWER(TC403,ORD(Coeff)))) =e= 0;
1846 EQU793..xx4HC32 * MW4 * FmHC32 - FHC32 * x4HC32 =e= 0;
1847 EQU794..xx3HC32 * MW3 * FmHC32 - FHC32 * x3HC32 =e= 0;
1848 EQU795..FmHC32 - FHC32 * (x1HC32/MW1 + x3HC32/MW3 + x4HC32/MW4 + x5HC32/MW5 + x7HC32/MW7) =e= 0;
1849 EQU796..hHC32 - FHC32 * ((x1HC32/MW1)*(SUM(Coeff,1/ORD(Coeff)* Enth_liq("1",Coeff) *POWER(THC32,ORD(Coeff))))
1850 +(x3HC32/MW3)*(SUM(Coeff,1/ORD(Coeff)* Enth_liq("3",Coeff) * POWER(THC32,ORD(Coeff))))
1851 +(x4HC32/MW4)*(SUM(Coeff,1/ORD(Coeff)* Enth_liq("4",Coeff) *POWER(THC32,ORD(Coeff))))
1852 +(x5HC32/MW5)*(SUM(Coeff,1/ORD(Coeff)* Enth_liq("5",Coeff) *POWER(THC32,ORD(Coeff))))
1853 +(x7HC32/MW7)*(SUM(Coeff,1/ORD(Coeff)* Enth_liq("7",Coeff) *POWER(THC32,ORD(Coeff)))) =e= 0;
1854 EQU797..x1HC32 + x3HC32 + x4HC32 + x5HC32 + x7HC32 =e= 1;
1855 EQU798..xx1HC32 + xx3HC32 + xx4HC32 + xx5HC32 + xx7HC32 =e= 1;
1856 EQU799..hC302 - FC302 *
1857 ((x1C302/MW1)*(SUM(Coeff,1/ORD(Coeff)* Enth_liq("1",Coeff) *POWER(TC302,ORD(Coeff)))+ Enth_Vap("1","a1")*1000 *
((1-TC302/Enth_Vap("1","a2"))**Enth_Vap("1","a3")))
1858 +(x3C302/MW3)*(SUM(Coeff,1/ORD(Coeff)* Enth_liq("3",Coeff) * POWER(TC302,ORD(Coeff)))+ Enth_Vap("3","a1")*1000 *
((1-TC302/Enth_Vap("3","a2"))**Enth_Vap("3","a3")))
1859 +(x4C302/MW4)*(SUM(Coeff,1/ORD(Coeff)* Enth_liq("4",Coeff) *POWER(TC302,ORD(Coeff)))+ Enth_Vap("4","a1")*1000 *
((1-TC302/Enth_Vap("4","a2"))**Enth_Vap("4","a3")))
_Economic Optimization Program
05/15/01 16:49:39 PAGE 43

```

GAMS 2.50A Windows NT/95/98

```

1860 +(x5C302/MW5)*(SUM(Coeff,1/ORD(Coeff)* Enth_liq("5",Coeff) *POWER(TC302,ORD(Coeff)))+ Enth_Vap("5","a1")*1000 *
((1-TC302/Enth_Vap("5","a2"))**Enth_Vap("5","a3")))

```

1861 +(x7C302/MW7)\*(SUM(Coeff,1/ORD(Coeff))\*Enth\_liq("7",Coeff)\*POWER(TC302,ORD(Coeff))+Enth\_Vap("7","a1")\*1000\*  
((1-TC302/Enth\_Vap("7","a2"))\*Enth\_Vap("7","a3")))=e=0;  
1862 EQU800..xx7C302 \* MW7 \* FmC302 - FC302 \* x7C302 =e= 0;  
1863 EQU801..xx5C302 \* MW5 \* FmC302 - FC302 \* x5C302 =e= 0;  
1864 EQU802..xx4C302 \* MW4 \* FmC302 - FC302 \* x4C302 =e= 0;  
1865 EQU803..xx3C302 \* MW3 \* FmC302 - FC302 \* x3C302 =e= 0;  
1866 EQU804..FmC302 - FC302 \* (x1C302/MW1 + x3C302/MW3 + x4C302/MW4 + x5C302/MW5 + x7C302/MW7) =e= 0;  
1867 EQU805..x1C302 + x3C302 + x4C302 + x5C302 + x7C302 =e= 1;  
1868 EQU806..xx1C302 + xx3C302 + xx4C302 + xx5C302 + xx7C302 =e= 1;  
1869 EQU807..x1C301 + x2C301 + x3C301 + x4C301 + x5C301 + x7C301 =e= 1;  
1870 EQU808..hC301 - FC301 \*  
1871 ((x1C301/MW1)\*(SUM(Coeff,1/ORD(Coeff))\*Enth\_liq("1",Coeff)\*POWER(TC301,ORD(Coeff))+Enth\_Vap("1","a1")\*1000\*  
((1-TC301/Enth\_Vap("1","a2"))\*Enth\_Vap("1","a3")))  
1872 +(x3C301/MW3)\*(SUM(Coeff,1/ORD(Coeff))\*Enth\_liq("3",Coeff)\*POWER(TC301,ORD(Coeff))+Enth\_Vap("3","a1")\*1000\*  
((1-TC301/Enth\_Vap("3","a2"))\*Enth\_Vap("3","a3")))  
1873 +(x4C301/MW4)\*(SUM(Coeff,1/ORD(Coeff))\*Enth\_liq("4",Coeff)\*POWER(TC301,ORD(Coeff))+Enth\_Vap("4","a1")\*1000\*  
((1-TC301/Enth\_Vap("4","a2"))\*Enth\_Vap("4","a3")))  
1874 +(x5C301/MW5)\*(SUM(Coeff,1/ORD(Coeff))\*Enth\_liq("5",Coeff)\*POWER(TC301,ORD(Coeff))+Enth\_Vap("5","a1")\*1000\*  
((1-TC301/Enth\_Vap("5","a2"))\*Enth\_Vap("5","a3")))  
1875 +(x7C301/MW7)\*(SUM(Coeff,1/ORD(Coeff))\*Enth\_liq("7",Coeff)\*POWER(TC301,ORD(Coeff))+Enth\_Vap("7","a1")\*1000\*  
((1-TC301/Enth\_Vap("7","a2"))\*Enth\_Vap("7","a3")))=e=0;  
1876 EQU809..hC303 - hC302 - hC301 =e= 0;  
1877 EQU810..FC303 \* x5C303 - FC302 \* x5C302 - FC301 \* x5C301 =e= 0;  
1878 EQU811..FC303 \* x4C303 - FC302 \* x4C302 - FC301 \* x4C301 =e= 0;  
1879 EQU812..FC303 \* x3C303 - FC302 \* x3C302 - FC301 \* x3C301 =e= 0;  
1880 EQU813..FC303 \* x1C303 - FC302 \* x1C302 - FC301 \* x1C301 =e= 0;  
1881 EQU814..FC303 - FC302 - FC301 =e= 0;  
1882 EQU815..x1HC02 + x2HC02 + x3HC02 + x4HC02 + x5HC02 + x7HC02 =e= 1;  
1883 EQU816..hHC02 - FHC02 \* ((x1HC02/MW1)\*(SUM(Coeff,1/ORD(Coeff))\*Enth\_liq("1",Coeff)\*POWER(THC02,ORD(Coeff))))  
1884 +(x2HC02/MW2)\*(SUM(Coeff,1/ORD(Coeff))\*Enth\_liq("2",Coeff)\*POWER(THC02,ORD(Coeff)))  
1885 +(x3HC02/MW3)\*(SUM(Coeff,1/ORD(Coeff))\*Enth\_liq("3",Coeff)\*POWER(THC02,ORD(Coeff)))  
1886 +(x4HC02/MW4)\*(SUM(Coeff,1/ORD(Coeff))\*Enth\_liq("4",Coeff)\*POWER(THC02,ORD(Coeff)))  
1887 +(x5HC02/MW5)\*(SUM(Coeff,1/ORD(Coeff))\*Enth\_liq("5",Coeff)\*POWER(THC02,ORD(Coeff)))  
1888 +(x7HC02/MW7)\*(SUM(Coeff,1/ORD(Coeff))\*Enth\_liq("7",Coeff)\*POWER(THC02,ORD(Coeff))) =e= 0;  
1889 EQU817..x1HC05 + x2HC05 + x3HC05 + x4HC05 + x5HC05 + x7HC05 =e= 1;  
1890 EQU818..hHC05 - FHC05 \* ((x1HC05/MW1)\*(SUM(Coeff,1/ORD(Coeff))\*Enth\_liq("1",Coeff)\*POWER(THC05,ORD(Coeff))))  
1891 +(x2HC05/MW2)\*(SUM(Coeff,1/ORD(Coeff))\*Enth\_liq("2",Coeff)\*POWER(THC05,ORD(Coeff)))  
1892 +(x3HC05/MW3)\*(SUM(Coeff,1/ORD(Coeff))\*Enth\_liq("3",Coeff)\*POWER(THC05,ORD(Coeff)))  
1893 +(x4HC05/MW4)\*(SUM(Coeff,1/ORD(Coeff))\*Enth\_liq("4",Coeff)\*POWER(THC05,ORD(Coeff)))  
1894 +(x5HC05/MW5)\*(SUM(Coeff,1/ORD(Coeff))\*Enth\_liq("5",Coeff)\*POWER(THC05,ORD(Coeff)))  
1895 +(x7HC05/MW7)\*(SUM(Coeff,1/ORD(Coeff))\*Enth\_liq("7",Coeff)\*POWER(THC05,ORD(Coeff))) =e= 0;  
1896 EQU819..x1HC04 + x2HC04 + x3HC04 + x4HC04 + x5HC04 + x7HC04 =e= 1;  
1897 EQU820..hHC04 - FHC04 \* ((x1HC04/MW1)\*(SUM(Coeff,1/ORD(Coeff))\*Enth\_liq("1",Coeff)\*POWER(THC04,ORD(Coeff))))  
1898 +(x2HC04/MW2)\*(SUM(Coeff,1/ORD(Coeff))\*Enth\_liq("2",Coeff)\*POWER(THC04,ORD(Coeff)))  
\_Economic Optimization Program 05/15/01 16:49:39 PAGE 44  
GAMS 2.50A Windows NT/95/98  
1899 +(x3HC04/MW3)\*(SUM(Coeff,1/ORD(Coeff))\*Enth\_liq("3",Coeff)\*POWER(THC04,ORD(Coeff)))  
1900 +(x4HC04/MW4)\*(SUM(Coeff,1/ORD(Coeff))\*Enth\_liq("4",Coeff)\*POWER(THC04,ORD(Coeff)))  
1901 +(x5HC04/MW5)\*(SUM(Coeff,1/ORD(Coeff))\*Enth\_liq("5",Coeff)\*POWER(THC04,ORD(Coeff)))  
1902 +(x7HC04/MW7)\*(SUM(Coeff,1/ORD(Coeff))\*Enth\_liq("7",Coeff)\*POWER(THC04,ORD(Coeff))) =e= 0;  
1903 EQU821..hC402 - FC402 \* ((x1C402/MW1)\*(SUM(Coeff,1/ORD(Coeff))\*Enth\_liq("1",Coeff)\*POWER(TC402,ORD(Coeff))))  
1904 +(x3C402/MW3)\*(SUM(Coeff,1/ORD(Coeff))\*Enth\_liq("3",Coeff)\*POWER(TC402,ORD(Coeff)))  
1905 +(x4C402/MW4)\*(SUM(Coeff,1/ORD(Coeff))\*Enth\_liq("4",Coeff)\*POWER(TC402,ORD(Coeff)))  
1906 +(x5C402/MW5)\*(SUM(Coeff,1/ORD(Coeff))\*Enth\_liq("5",Coeff)\*POWER(TC402,ORD(Coeff)))  
1907 +(x7C402/MW7)\*(SUM(Coeff,1/ORD(Coeff))\*Enth\_liq("7",Coeff)\*POWER(TC402,ORD(Coeff))) =e= 0;  
1908 EQU822..x1C402 + x3C402 + x4C402 + x5C402 + x7C402 =e= 1;  
1909 EQU823..FHC01 - FHC02 =e= 0;  
1910 EQU824..FC401 - FC402 =e= 0;  
1911 EQU825..(hHC02 - hHC01) - (hC401 - hC402) =e= 0;  
1912 EQU826..(hHC01 - hHC02) - UE628\*AE628\*FE628\*dTE628 =e= 0;  
1913 EQU827..x1HC01 - x1HC02 =e= 0;  
1914 EQU828..x2HC01 - x2HC02 =e= 0;  
1915 EQU829..x3HC01 - x3HC02 =e= 0;  
1916 EQU830..x4HC01 - x4HC02 =e= 0;  
1917 EQU831..x5HC01 - x5HC02 =e= 0;  
1918 EQU832..hC321 - FC321 \* ((x1C321/MW1)\*(SUM(Coeff,1/ORD(Coeff))\*Enth\_liq("1",Coeff)\*POWER(TC321,ORD(Coeff))))  
1919 +(x3C321/MW3)\*(SUM(Coeff,1/ORD(Coeff))\*Enth\_liq("3",Coeff)\*POWER(TC321,ORD(Coeff)))  
1920 +(x4C321/MW4)\*(SUM(Coeff,1/ORD(Coeff))\*Enth\_liq("4",Coeff)\*POWER(TC321,ORD(Coeff)))  
1921 +(x5C321/MW5)\*(SUM(Coeff,1/ORD(Coeff))\*Enth\_liq("5",Coeff)\*POWER(TC321,ORD(Coeff)))  
1922 +(x7C321/MW7)\*(SUM(Coeff,1/ORD(Coeff))\*Enth\_liq("7",Coeff)\*POWER(TC321,ORD(Coeff))) =e= 0;  
1923 EQU833..FmC322 - FC322 \* (x1C322/MW1 + x3C322/MW3 + x4C322/MW4 + x5C322/MW5 + x7C322/MW7) =e= 0;  
1924 EQU834..hC323 - FC323 \* ((x1C323/MW1)\*(SUM(Coeff,1/ORD(Coeff))\*Enth\_liq("1",Coeff)\*POWER(TC323,ORD(Coeff))))  
1925 +(x3C323/MW3)\*(SUM(Coeff,1/ORD(Coeff))\*Enth\_liq("3",Coeff)\*POWER(TC323,ORD(Coeff)))  
1926 +(x4C323/MW4)\*(SUM(Coeff,1/ORD(Coeff))\*Enth\_liq("4",Coeff)\*POWER(TC323,ORD(Coeff)))  
1927 +(x5C323/MW5)\*(SUM(Coeff,1/ORD(Coeff))\*Enth\_liq("5",Coeff)\*POWER(TC323,ORD(Coeff)))  
1928 +(x7C323/MW7)\*(SUM(Coeff,1/ORD(Coeff))\*Enth\_liq("7",Coeff)\*POWER(TC323,ORD(Coeff))) =e= 0;  
1929 EQU835..hC326 - (FC326/MW1)\*(SUM(Coeff,1/ORD(Coeff))\*Enth\_liq("1",Coeff)\*POWER(TC326,ORD(Coeff)))  
1930 =e= 0;  
1931 EQU836..hC329 - (FC329/MW1)\*(SUM(Coeff,1/ORD(Coeff))\*Enth\_liq("1",Coeff)\*POWER(TC329,ORD(Coeff)))  
1932 =e= 0;  
1933 EQU837..x1C401 - x1C402 =e= 0;  
1934 EQU838..x3C401 - x3C402 =e= 0;  
1935 EQU839..x4C401 - x4C402 =e= 0;  
1936 EQU840..x5C401 - x5C402 =e= 0;  
1937 EQU841..(hC403 - hC402) - UE629\*AE629\*FE629\*dTE629 =e= 0;  
1938 EQU842..(hC402 - hC403) - (hHC04 - hHC03) =e= 0;  
1939 EQU843..FHC03 - FHC04 =e= 0;  
1940 EQU844..FC402 - FC403 =e= 0;  
1941 EQU845..x5C402 - x5C403 =e= 0;  
1942 EQU846..x4C402 - x4C403 =e= 0;

1943 EQU847..x3C402 - x3C403 =e= 0;  
1944 EQU848..x1C402 - x1C403 =e= 0;  
\_Economic Optimization Program

05/15/01 16:49:39 PAGE 45  
GAMS 2.50A Windows NT/95/98

1945 EQU849..x5HC03 - x5HC04 =e= 0;  
1946 EQU850..x4HC03 - x4HC04 =e= 0;  
1947 EQU851..x3HC03 - x3HC04 =e= 0;  
1948 EQU852..x2HC03 - x2HC04 =e= 0;  
1949 EQU853..x1HC03 - x1HC04 =e= 0;  
1950 EQU854..FHC04 - FHC05 =e= 0;  
1951 EQU855..THC29 - THC30 =e= 0;  
1952 EQU856..(FIHC29\*x5HC29 + FvHC29\*y5HC29) - (FIHC30\*x5HC30 + FvHC30\*y5HC30) =e= 0;  
1953 EQU857..(FIHC29\*x4HC29 + FvHC29\*y4HC29) - (FIHC30\*x4HC30 + FvHC30\*y4HC30) =e= 0;  
1954 EQU858..(FIHC29\*x3HC29 + FvHC29\*y3HC29) - (FIHC30\*x3HC30 + FvHC30\*y3HC30) =e= 0;  
1955 EQU859..(FIHC29\*x1HC29 + FvHC29\*y1HC29) - (FIHC30\*x1HC30 + FvHC30\*y1HC30) =e= 0;  
1956 EQU860..(hHC04 - hHC05) - UE633\*AE633\*dTE633 =e= 0;  
1957 EQU861..(hHC04 - hHC05) - (hHC30 - hHC29) =e= 0;  
1958 EQU862..(FIHC29 + FvHC29) - (FIHC30 + FvHC30) =e= 0;  
1959 EQU863..x5HC04 - x5HC05 =e= 0;  
1960 EQU864..x4HC04 - x4HC05 =e= 0;  
1961 EQU865..x3HC04 - x3HC05 =e= 0;  
1962 EQU866..x2HC04 - x2HC05 =e= 0;  
1963 EQU867..x1HC04 - x1HC05 =e= 0;  
1964 EQU868..dTE628 \*\*3=e= ((THC02-TC401)\*(THC01-TC402)\*  
1965 ((THC02-TC401)+(THC01-TC402))/2);  
1966 EQU869..dTE629 \*\*3=e= ((THC03-TC403)\*(THC04-TC402)\*  
1967 ((THC03-TC403)\*(THC04-TC402))/2);  
1968 EQU870..hC309 - FC309 \* ((x1C309/MW1)\*(SUM(Coeff,1/ORD(Coeff) \* Enth\_liq("1",Coeff) \*POWER(TC309,ORD(Coeff))))  
1969 +(x3C309/MW3)\*(SUM(Coeff,1/ORD(Coeff) \* Enth\_liq("3",Coeff) \* POWER(TC309,ORD(Coeff))))  
1970 +(x4C309/MW4)\*(SUM(Coeff,1/ORD(Coeff) \* Enth\_liq("4",Coeff) \* POWER(TC309,ORD(Coeff))))  
1971 +(x5C309/MW5)\*(SUM(Coeff,1/ORD(Coeff) \* Enth\_liq("5",Coeff) \* POWER(TC309,ORD(Coeff))))  
1972 +(x7C309/MW7)\*(SUM(Coeff,1/ORD(Coeff) \* Enth\_liq("7",Coeff) \* POWER(TC309,ORD(Coeff)))) =e= 0;  
1973 EQU871..THC34 - THC32 =e= 0;  
1974 EQU872..hHC34 - FHC34 \* ((x1HC34/MW1)\*(SUM(Coeff,1/ORD(Coeff) \* Enth\_liq("1",Coeff) \*POWER(THC34,ORD(Coeff))))  
1975 +(x3HC34/MW3)\*(SUM(Coeff,1/ORD(Coeff) \* Enth\_liq("3",Coeff) \* POWER(THC34,ORD(Coeff))))  
1976 +(x4HC34/MW4)\*(SUM(Coeff,1/ORD(Coeff) \* Enth\_liq("4",Coeff) \* POWER(THC34,ORD(Coeff))))  
1977 +(x5HC34/MW5)\*(SUM(Coeff,1/ORD(Coeff) \* Enth\_liq("5",Coeff) \* POWER(THC34,ORD(Coeff))))  
1978 +(x7HC34/MW7)\*(SUM(Coeff,1/ORD(Coeff) \* Enth\_liq("7",Coeff) \* POWER(THC34,ORD(Coeff)))) =e= 0;  
1979 EQU873..hHC38 - FHC38 \* ((x1HC38/MW1)\*(SUM(Coeff,1/ORD(Coeff) \* Enth\_liq("1",Coeff) \*POWER(THC38,ORD(Coeff))))  
1980 +(x3HC38/MW3)\*(SUM(Coeff,1/ORD(Coeff) \* Enth\_liq("3",Coeff) \* POWER(THC38,ORD(Coeff))))  
1981 +(x4HC38/MW4)\*(SUM(Coeff,1/ORD(Coeff) \* Enth\_liq("4",Coeff) \* POWER(THC38,ORD(Coeff))))  
1982 +(x5HC38/MW5)\*(SUM(Coeff,1/ORD(Coeff) \* Enth\_liq("5",Coeff) \* POWER(THC38,ORD(Coeff))))  
1983 +(x7HC38/MW7)\*(SUM(Coeff,1/ORD(Coeff) \* Enth\_liq("7",Coeff) \* POWER(THC38,ORD(Coeff)))) =e= 0;  
1984 EQU874..THC38 - THC32 =e= 0;  
1985 EQU875..THC32 - THC41 =e= 0;  
1986 EQU876..hHC41 - FHC41 \* ((x1HC41/MW1)\*(SUM(Coeff,1/ORD(Coeff) \* Enth\_liq("1",Coeff) \*POWER(THC41,ORD(Coeff))))  
1987 +(x3HC41/MW3)\*(SUM(Coeff,1/ORD(Coeff) \* Enth\_liq("3",Coeff) \* POWER(THC41,ORD(Coeff))))  
1988 +(x4HC41/MW4)\*(SUM(Coeff,1/ORD(Coeff) \* Enth\_liq("4",Coeff) \* POWER(THC41,ORD(Coeff))))  
1989 +(x5HC41/MW5)\*(SUM(Coeff,1/ORD(Coeff) \* Enth\_liq("5",Coeff) \* POWER(THC41,ORD(Coeff))))  
1990 +(x7HC41/MW7)\*(SUM(Coeff,1/ORD(Coeff) \* Enth\_liq("7",Coeff) \* POWER(THC41,ORD(Coeff)))) =e= 0;  
\_Economic Optimization Program

05/15/01 16:49:39 PAGE 46  
GAMS 2.50A Windows NT/95/98

1991 EQU877..THC32 - THC45 =e= 0;  
1992 EQU878..hHC45 - FHC45 \* ((x1HC45/MW1)\*(SUM(Coeff,1/ORD(Coeff) \* Enth\_liq("1",Coeff) \*POWER(THC45,ORD(Coeff))))  
1993 +(x3HC45/MW3)\*(SUM(Coeff,1/ORD(Coeff) \* Enth\_liq("3",Coeff) \* POWER(THC45,ORD(Coeff))))  
1994 +(x4HC45/MW4)\*(SUM(Coeff,1/ORD(Coeff) \* Enth\_liq("4",Coeff) \* POWER(THC45,ORD(Coeff))))  
1995 +(x5HC45/MW5)\*(SUM(Coeff,1/ORD(Coeff) \* Enth\_liq("5",Coeff) \* POWER(THC45,ORD(Coeff))))  
1996 +(x7HC45/MW7)\*(SUM(Coeff,1/ORD(Coeff) \* Enth\_liq("7",Coeff) \* POWER(THC45,ORD(Coeff)))) =e= 0;  
1997 EQU879..hHC06 - FHC06 \* ((x1HC06/MW1)\*(SUM(Coeff,1/ORD(Coeff) \* Enth\_liq("1",Coeff) \*POWER(THC06,ORD(Coeff))))  
1998 +(x2HC06/MW2)\*(SUM(Coeff,1/ORD(Coeff) \* Enth\_liq("2",Coeff) \* POWER(THC06,ORD(Coeff))))  
1999 +(x3HC06/MW3)\*(SUM(Coeff,1/ORD(Coeff) \* Enth\_liq("3",Coeff) \* POWER(THC06,ORD(Coeff))))  
2000 +(x4HC06/MW4)\*(SUM(Coeff,1/ORD(Coeff) \* Enth\_liq("4",Coeff) \* POWER(THC06,ORD(Coeff))))  
2001 +(x5HC06/MW5)\*(SUM(Coeff,1/ORD(Coeff) \* Enth\_liq("5",Coeff) \* POWER(THC06,ORD(Coeff))))  
2002 +(x7HC06/MW7)\*(SUM(Coeff,1/ORD(Coeff) \* Enth\_liq("7",Coeff) \* POWER(THC06,ORD(Coeff)))) =e= 0;  
2003 EQU880..hHC06 -hHC02 - hHC05 =e= 0;  
2004 EQU881..THC06 - THC07 =e= 0;  
2005 EQU882..hHC07 - FHC07 \* ((x1HC07/MW1)\*(SUM(Coeff,1/ORD(Coeff) \* Enth\_liq("1",Coeff) \*POWER(THC07,ORD(Coeff))))  
2006 +(x2HC07/MW2)\*(SUM(Coeff,1/ORD(Coeff) \* Enth\_liq("2",Coeff) \* POWER(THC07,ORD(Coeff))))  
2007 +(x3HC07/MW3)\*(SUM(Coeff,1/ORD(Coeff) \* Enth\_liq("3",Coeff) \* POWER(THC07,ORD(Coeff))))  
2008 +(x4HC07/MW4)\*(SUM(Coeff,1/ORD(Coeff) \* Enth\_liq("4",Coeff) \* POWER(THC07,ORD(Coeff))))  
2009 +(x5HC07/MW5)\*(SUM(Coeff,1/ORD(Coeff) \* Enth\_liq("5",Coeff) \* POWER(THC07,ORD(Coeff))))  
2010 +(x7HC07/MW7)\*(SUM(Coeff,1/ORD(Coeff) \* Enth\_liq("7",Coeff) \* POWER(THC07,ORD(Coeff)))) =e= 0;  
2011 EQU883..THC06 -THC11 =e= 0;  
2012 EQU884..hHC11 - FHC11 \* ((x1HC11/MW1)\*(SUM(Coeff,1/ORD(Coeff) \* Enth\_liq("1",Coeff) \*POWER(THC11,ORD(Coeff))))  
2013 +(x2HC11/MW2)\*(SUM(Coeff,1/ORD(Coeff) \* Enth\_liq("2",Coeff) \* POWER(THC11,ORD(Coeff))))  
2014 +(x3HC11/MW3)\*(SUM(Coeff,1/ORD(Coeff) \* Enth\_liq("3",Coeff) \* POWER(THC11,ORD(Coeff))))  
2015 +(x4HC11/MW4)\*(SUM(Coeff,1/ORD(Coeff) \* Enth\_liq("4",Coeff) \* POWER(THC11,ORD(Coeff))))  
2016 +(x5HC11/MW5)\*(SUM(Coeff,1/ORD(Coeff) \* Enth\_liq("5",Coeff) \* POWER(THC11,ORD(Coeff))))  
2017 +(x7HC11/MW7)\*(SUM(Coeff,1/ORD(Coeff) \* Enth\_liq("7",Coeff) \* POWER(THC11,ORD(Coeff)))) =e= 0;  
2018 EQU885..THC06 -THC14 =e= 0;  
2019 EQU886..hHC14 - FHC14 \* ((x1HC14/MW1)\*(SUM(Coeff,1/ORD(Coeff) \* Enth\_liq("1",Coeff) \*POWER(THC14,ORD(Coeff))))  
2020 +(x2HC14/MW2)\*(SUM(Coeff,1/ORD(Coeff) \* Enth\_liq("2",Coeff) \* POWER(THC14,ORD(Coeff))))  
2021 +(x3HC14/MW3)\*(SUM(Coeff,1/ORD(Coeff) \* Enth\_liq("3",Coeff) \* POWER(THC14,ORD(Coeff))))  
2022 +(x4HC14/MW4)\*(SUM(Coeff,1/ORD(Coeff) \* Enth\_liq("4",Coeff) \* POWER(THC14,ORD(Coeff))))  
2023 +(x5HC14/MW5)\*(SUM(Coeff,1/ORD(Coeff) \* Enth\_liq("5",Coeff) \* POWER(THC14,ORD(Coeff))))  
2024 +(x7HC14/MW7)\*(SUM(Coeff,1/ORD(Coeff) \* Enth\_liq("7",Coeff) \* POWER(THC14,ORD(Coeff)))) =e= 0;  
2025 EQU887..THC06 -THC16 =e= 0;  
2026 EQU888..hHC16 - FHC16 \* ((x1HC16/MW1)\*(SUM(Coeff,1/ORD(Coeff) \* Enth\_liq("1",Coeff) \*POWER(THC16,ORD(Coeff))))

2027 +(x2HC16/MW2)\*(SUM(Coeff,1/ORD(Coeff)\* Enth\_liq("2",Coeff) \* POWER(THC16,ORD(Coeff))))  
 2028 +(x3HC16/MW3)\*(SUM(Coeff,1/ORD(Coeff)\* Enth\_liq("3",Coeff) \* POWER(THC16,ORD(Coeff))))  
 2029 +(x4HC16/MW4)\*(SUM(Coeff,1/ORD(Coeff)\* Enth\_liq("4",Coeff) \* POWER(THC16,ORD(Coeff))))  
 2030 +(x5HC16/MW5)\*(SUM(Coeff,1/ORD(Coeff)\* Enth\_liq("5",Coeff) \* POWER(THC16,ORD(Coeff))))  
 2031 +(x7HC16/MW7)\*(SUM(Coeff,1/ORD(Coeff)\* Enth\_liq("7",Coeff) \* POWER(THC16,ORD(Coeff)))) =e= 0;  
 2032 EQU889..hC432 - FC432 \*  
 2033 ((x3C432/MW3)\*(SUM(Coeff,1/ORD(Coeff)\* Enth\_liq("3",Coeff) \* POWER(TC432,ORD(Coeff)))+ Enth\_Vap("3","a1")\*1000 \*  
 ((1-TC432/Enth\_Vap("3","a2"))\*\*Enth\_Vap("3","a3")))  
 2034 +(x4C432/MW4)\*(SUM(Coeff,1/ORD(Coeff)\* Enth\_liq("4",Coeff) \* POWER(TC432,ORD(Coeff)))+ Enth\_Vap("4","a1")\*1000 \*  
 ((1-TC432/Enth\_Vap("4","a2"))\*\*Enth\_Vap("4","a3")))  
 \_Economic Optimization Program 05/15/01 16:49:39 PAGE 47  
 GAMS 2.50A Windows NT/95/98

2035 +(x5C432/MW5)\*(SUM(Coeff,1/ORD(Coeff)\* Enth\_liq("5",Coeff) \* POWER(TC432,ORD(Coeff)))+ Enth\_Vap("5","a1")\*1000 \*  
 ((1-TC432/Enth\_Vap("5","a2"))\*\*Enth\_Vap("5","a3")))  
 2036 +(x7C432/MW7)\*(SUM(Coeff,1/ORD(Coeff)\* Enth\_liq("7",Coeff) \* POWER(TC432,ORD(Coeff)))+ Enth\_Vap("7","a1")\*1000 \*  
 ((1-TC432/Enth\_Vap("7","a2"))\*\*Enth\_Vap("7","a3")))) =e= 0;  
 2037 EQU890..x1C432 + x3C432 + x4C432 + x5C432 + x7C432 =e= 1;  
 2038 EQU891..FmC432 - FC432 \* (x1C432/MW1 + x3C432/MW3 + x4C432/MW4 + x5C432/MW5 + x7C432/MW7)=e= 0;  
 2039 EQU892..xx3C432 \* FmC432 \* MW3 - FC432 \* x3C432 =e= 0;  
 2040 EQU893..xx4C432 \* FmC432 \* MW4 - FC432 \* x4C432 =e= 0;  
 2041 EQU894..x1C430 + x3C430 + x4C430 + x5C430 + x7C430 =e= 1;  
 2042 EQU895..FmC430 - FC430 \* (x1C430/MW1 + x3C430/MW3 + x4C430/MW4 + x5C430/MW5 + x7C430/MW7)=e= 0;  
 2043 EQU896..xx3C430 \* FmC430 \* MW3 - FC430 \* x3C430 =e= 0;  
 2044 EQU897..hC430 - FC430 \* ((x1C430/MW1)\*(SUM(Coeff,1/ORD(Coeff)\* Enth\_liq("1",Coeff) \* POWER(TC430,ORD(Coeff))))  
 2045 +(x3C430/MW3)\*(SUM(Coeff,1/ORD(Coeff)\* Enth\_liq("3",Coeff) \* POWER(TC430,ORD(Coeff))))  
 2046 +(x4C430/MW4)\*(SUM(Coeff,1/ORD(Coeff)\* Enth\_liq("4",Coeff) \* POWER(TC430,ORD(Coeff))))  
 2047 +(x5C430/MW5)\*(SUM(Coeff,1/ORD(Coeff)\* Enth\_liq("5",Coeff) \* POWER(TC430,ORD(Coeff))))  
 2048 +(x7C430/MW7)\*(SUM(Coeff,1/ORD(Coeff)\* Enth\_liq("7",Coeff) \* POWER(TC430,ORD(Coeff)))) =e= 0;  
 2049 EQU898..xx4C430 \* FmC430 \* MW4 - FC430 \* x4C430 =e= 0;  
 2050 EQU899..xx1HC28 + xx2HC28 + xx3HC28 + xx4HC28 + xx5HC28 + xx7HC28 =e= 1;  
 2051 EQU900..FmHC28 - FHC28 \* (x1HC28/MW1 + x2HC28/MW2 + x3HC28/MW3 + x4HC28/MW4 + x5HC28/MW5 + x7HC28/MW7)=e= 0;  
 2052 EQU901..yy1HC28 + yy2HC28 + yy3HC28 + yy4HC28 + yy5HC28 + yy7HC28 =e= 1;  
 2053 EQU902..FmVHC28 - FvHC28 \* (y1HC28/MW1 + y2HC28/MW2 + y3HC28/MW3 + y4HC28/MW4 + y5HC28/MW5 + y7HC28/MW7)=e= 0;  
 2054 EQU903..y1HC28+y2HC28+y3HC28+y4HC28+y5HC28+y7HC28 =e=1;  
 2055 EQU904..xx1HC28 \* MW1 \* FmHC28 - FHC28 \* x1HC28 =e= 0 ;  
 2056 EQU905..xx3HC28 \* MW3 \* FmHC28 - FHC28 \* x3HC28 =e= 0 ;  
 2057 EQU906..xx4HC28 \* MW4 \* FmHC28 - FHC28 \* x4HC28 =e= 0 ;  
 2058 EQU907..xx5HC28 \* MW5 \* FmHC28 - FHC28 \* x5HC28 =e= 0 ;  
 2059 EQU908..xx7HC28 \* MW7 \* FmHC28 - FHC28 \* x7HC28 =e= 0 ;  
 2060 EQU909..yy7HC28 \* MW7 \* FmVHC28 - FvHC28 \* y7HC28 =e= 0 ;  
 2061 EQU910..yy5HC28 \* MW5 \* FmVHC28 - FvHC28 \* y5HC28 =e= 0 ;  
 2062 EQU911..yy4HC28 \* MW4 \* FmVHC28 - FvHC28 \* y4HC28 =e= 0 ;  
 2063 EQU912..yy3HC28 \* MW3 \* FmVHC28 - FvHC28 \* y3HC28 =e= 0 ;  
 2064 EQU913..yy1HC28 \* MW1 \* FmVHC28 - FvHC28 \* y1HC28 =e= 0 ;  
 2065 EQU914..FHC28 - FHC28 - FvHC28 =e= 0 ;  
 2066 EQU915..FvHC28 - VFM3\* FHC28 =e= 0 ;  
 2067 EQU916..xx1HC28 \* K1M3 =e= yy1HC28;  
 2068 EQU917..K1C606A\*PC606A =e= 0.1333\*10\*\* (21.4469-1.4627E3/TnC606A-5.261\*LOG10(TnC606A)+3.282E-11\*TnC606A+3.7349E-6\*TnC606A\*\*2);  
 2069 EQU918..xx2HC28 \* K2M3 =e= yy2HC28;  
 2070 EQU919..xx3HC28 \* K3M3 =e= yy3HC28;  
 2071 EQU920..xx4HC28 \* K4M3 =e= yy4HC28;  
 2072 EQU921..xx5HC28 \* K5M3 =e= yy5HC28;  
 2073 EQU922..xx7HC28 \* K7M3 =e= yy7HC28;  
 2074 EQU923..hC427 - FC427 \*  
 2075 ((x3C427/MW3)\*(SUM(Coeff,1/ORD(Coeff)\* Enth\_liq("3",Coeff) \* POWER(TC427,ORD(Coeff)))+ Enth\_Vap("3","a1")\*1000 \*  
 ((1-TC427/Enth\_Vap("3","a2"))\*\*Enth\_Vap("3","a3")))  
 2076 +(x4C427/MW4)\*(SUM(Coeff,1/ORD(Coeff)\* Enth\_liq("4",Coeff) \* POWER(TC427,ORD(Coeff)))+ Enth\_Vap("4","a1")\*1000 \*  
 ((1-TC427/Enth\_Vap("4","a2"))\*\*Enth\_Vap("4","a3")))  
 \_Economic Optimization Program 05/15/01 16:49:39 PAGE 48  
 GAMS 2.50A Windows NT/95/98

2077 +(x5C427/MW5)\*(SUM(Coeff,1/ORD(Coeff)\* Enth\_liq("5",Coeff) \* POWER(TC427,ORD(Coeff)))+ Enth\_Vap("5","a1")\*1000 \*  
 ((1-TC427/Enth\_Vap("5","a2"))\*\*Enth\_Vap("5","a3")))  
 2078 +(x7C427/MW7)\*(SUM(Coeff,1/ORD(Coeff)\* Enth\_liq("7",Coeff) \* POWER(TC427,ORD(Coeff)))+ Enth\_Vap("7","a1")\*1000 \*  
 ((1-TC427/Enth\_Vap("7","a2"))\*\*Enth\_Vap("7","a3")))) =e= 0;  
 2079 EQU924..x1C427 + x3C427 + x4C427 + x5C427 + x7C427 =e= 1;  
 2080 EQU925..FmC427 - FC427 \* (x1C427/MW1 + x3C427/MW3 + x4C427/MW4 + x5C427/MW5 + x7C427/MW7)=e= 0;  
 2081 EQU926..xx4C427 \* FmC427 \* MW4 - FC427 \* x4C427 =e= 0;  
 2082 EQU927..K3C606A\*PC606A =e= 0.1333\*10\*\* (31.2541-1.9532E3/TmC606A-8.806\*LOG10(TmC606A)+8.9246E-11\*TmC606A+5.7501E-6\*TmC606A\*\*2);  
 2083 EQU928..Kp3C606A\*PC606A =e= 0.1333\*10\*\* (31.2541-1.9532E3/TmC606A-8.806\*LOG10(TmC606A)+8.9246E-11\*TmC606A+5.7501E-6\*TmC606A\*\*2)  
 2084 EQU929..K4C606A\*PC606A =e= 0.1333\*10\*\* (27.0441-1.9049E3/TnC606A-7.1805\*LOG10(TnC606A)-6.6845E-11\*TnC606A+4.219E-6\*TnC606A\*\*2);  
 2085 EQU930..Kp4C606A\*PC606A =e= 0.1333\*10\*\* (27.0441-1.9049E3/TnC606A-7.1805\*LOG10(TnC606A)-6.6845E-11\*TnC606A+4.219E-6\*TnC606A\*\*2)  
 2086 EQU931..K5C606A\*PC606A =e= 0.1333\*10\*\* (29.2963-2.1762E3/TnC606A-7.883\*LOG10(TnC606A)-4.6512E-11\*TnC606A+3.8997E-6\*TnC606A\*\*2);  
 2087 EQU932..Kp5C606A\*PC606A =e= 0.1333\*10\*\* (29.2963-2.1762E3/TnC606A-7.883\*LOG10(TnC606A)-4.6512E-11\*TnC606A+3.8997E-6\*TnC606A\*\*2)  
 2088 EQU933..K7C606A\*PC606A =e= 0.1333\*10\*\* (33.0162-2.583E3/TmC606A-9.042\*LOG10(TmC606A)-1.371E-12\*TmC606A+3.634E-6\*TmC606A\*\*2);  
 2089 EQU934..Kp7C606A\*PC606A =e= 0.1333\*10\*\* (33.0162-2.583E3/TmC606A-9.042\*LOG10(TmC606A)-1.371E-12\*TmC606A+3.634E-6\*TmC606A\*\*2);  
 2090 EQU935..Sn1C606A\*FC322 =e= K1C606A\*FC414;  
 2091 EQU936..Sm1C606A\*LpC606A=e= Kp1C606A\*VpC606A;  
 2092 EQU937..Sn3C606A\*FC322 =e= K3C606A\*FC414;  
 2093 EQU938..Sm3C606A\*LpC606A=e= Kp3C606A\*VpC606A;  
 2094 EQU939..Sn4C606A\*FC322 =e= K4C606A\*FC414;  
 2095 EQU940..Sm4C606A\*LpC606A=e= Kp4C606A\*VpC606A;  
 2096 EQU941..Sn5C606A\*FC322 =e= K5C606A\*FC414;  
 2097 EQU942..Sm5C606A\*LpC606A=e= Kp5C606A\*VpC606A;  
 2098 EQU943..Sn7C606A\*FC322 =e= K7C606A\*FC414;  
 2099 EQU944..Sm7C606A\*LpC606A=e= Kp7C606A\*VpC606A;

2100 EQU945..f1C606A\*((1-Sn1C606A\*\*(56-47))/1E20+ h1C606A\*Sn1C606A\*\*(56-47)\*(1-Sm1C606A\*\*(47+1))/1E20)=e= (1-Sn1C606A\*\*(56-47))/1E20+ qS1C606A\*(Sn1C606A\*\*(56-47)-Sn1C606A)/1E20+qFp1C606A\*h1C606A\*Sn1C606A\*\*(56-47)\*(1-Sm1C606A\*\*(47+1))/1E20

2101 ;

2102 EQU946..f3C606A\*((1-Sn3C606A\*\*(56-47))/1E10+ h3C606A\*Sn3C606A\*\*(56-47)\*(1-Sm3C606A\*\*(47+1))/1E10)=e= (1-Sn3C606A\*\*(56-47))/1E10+ qS3C606A\*(Sn3C606A\*\*(56-47)-Sn3C606A)/1E10+qFp3C606A\*h3C606A\*Sn3C606A\*\*(56-47)\*(1-Sm3C606A\*\*(47+1))/1E10

2103 ;

2104 EQU947..f4C606A\*((1-Sn4C606A\*\*(56-47))+ h4C606A\*Sn4C606A\*\*(56-47)\*(1-Sm4C606A\*\*(47+1)))=e= (1-Sn4C606A\*\*(56-47))+ qS4C606A\*(Sn4C606A\*\*(56-47)-Sn4C606A)+qFp4C606A\*h4C606A\*Sn4C606A\*\*(56-47)\*(1-Sm4C606A\*\*(47+1))

2105 ;

2106 EQU948..f5C606A\*((1-Sn5C606A\*\*(56-47))+ h5C606A\*Sn5C606A\*\*(56-47)\*(1-Sm5C606A\*\*(47+1)))=e= (1-Sn5C606A\*\*(56-47))+ qS5C606A\*(Sn5C606A\*\*(56-47)-Sn5C606A)+qFp5C606A\*h5C606A\*Sn5C606A\*\*(56-47)\*(1-Sm5C606A\*\*(47+1))

2107 ;

2108 EQU949..f7C606A\*((1-Sn7C606A\*\*(56-47))+ h7C606A\*Sn7C606A\*\*(56-47)\*(1-Sm7C606A\*\*(47+1)))=e= (1-Sn7C606A\*\*(56-47))+ qS7C606A\*(Sn7C606A\*\*(56-47)-Sn7C606A)+qFp7C606A\*h7C606A\*Sn7C606A\*\*(56-47)\*(1-Sm7C606A\*\*(47+1))

2109 ;

2110 EQU950..f1C606A \*(x1C404 \* FC404 + x1C322 \* FC322 + x1C432 \* FC432) =e= x1C430 \* FC430;

2111 EQU951..f3C606A \*(x3C404 \* FC404 + x3C322 \* FC322 + x3C432 \* FC432) =e= x3C430 \* FC430;

2112 EQU952..f4C606A \*(x4C404 \* FC404 + x4C322 \* FC322 + x4C432 \* FC432) =e= x4C430 \* FC430;

\_Economic Optimization Program 05/15/01 16:49:39 PAGE 49

GAMS 2.50A Windows NT/95/98

2113 EQU953..f5C606A \*(x5C404 \* FC404 + x5C322 \* FC322 + x5C432 \* FC432) =e= x5C430 \* FC430;

2114 EQU954..f7C606A \*(x7C404 \* FC404 + x7C322 \* FC322 + x7C432 \* FC432) =e= x7C430 \* FC430;

2115 EQU955..h1C606A\*LpC606A\*(1-Sm1C606A)=e= FC322\*(1-Sn1C606A);

2116 EQU956..h3C606A\*LpC606A\*(1-Sm3C606A)=e= FC322\*(1-Sn3C606A);

2117 EQU957..h4C606A\*LpC606A\*(1-Sm4C606A)=e= FC322\*(1-Sn4C606A);

2118 EQU958..Kp1C606A\*PC606A=e= 0.1333\*10\*\*(21.4469-1.4627E3/TmC606A-5.261\*LOG10(TmC606A)+3.282E-11\*TmC606A+3.7349E-6\*TmC606A\*\*2);

2119 EQU959..FmC414 - FC414 \* (x1C414/MW1 + x3C414/MW3 + x4C414/MW4 + x5C414/MW5 + x7C414/MW7) =e= 0;

2120 EQU960..xx3C414 \* FmC414 \* MW3 - FC414 \* x3C414 =e= 0;

2121 EQU961..hC322 - FC322 \* ((x1C322/MW1) \* (SUM(Coeff,1/ORD(Coeff)) \* Enth\_liq("1",Coeff) \* POWER(TC322,ORD(Coeff))))

2122 + (x3C322/MW3) \* (SUM(Coeff,1/ORD(Coeff)) \* Enth\_liq("3",Coeff) \* POWER(TC322,ORD(Coeff))))

2123 + (x4C322/MW4) \* (SUM(Coeff,1/ORD(Coeff)) \* Enth\_liq("4",Coeff) \* POWER(TC322,ORD(Coeff))))

2124 + (x5C322/MW5) \* (SUM(Coeff,1/ORD(Coeff)) \* Enth\_liq("5",Coeff) \* POWER(TC322,ORD(Coeff))))

2125 + (x7C322/MW7) \* (SUM(Coeff,1/ORD(Coeff)) \* Enth\_liq("7",Coeff) \* POWER(TC322,ORD(Coeff)))) =e= 0;

2126 EQU962..xx3C322 \* FmC322 \* MW3 - FC322 \* x3C322 =e= 0;

2127 EQU963..FC427 - FC431 =e= 0;

2128 EQU964..TC431 - TC425 =e= 0;

2129 EQU965..x1C428 + x3C428 + x4C428 + x5C428 + x7C428 =e= 1;

2130 EQU966..FmC428 - FC428 \* (x1C428/MW1 + x3C428/MW3 + x4C428/MW4 + x5C428/MW5 + x7C428/MW7)=e= 0;

2131 EQU967..xx4C428 \* FmC428 \* MW4 - FC428 \* x4C428 =e= 0;

2132 EQU968..x1C425 + x3C425 + x4C425 + x5C425 + x7C425 =e= 1;

2133 EQU969..FmC425 - FC425 \* (x1C425/MW1 + x3C425/MW3 + x4C425/MW4 + x5C425/MW5 + x7C425/MW7)=e= 0;

2134 EQU970..xx4C425 \* FmC425 \* MW4 - FC425 \* x4C425 =e= 0;

2135 EQU971..x1C408 - x1C405 =e= 0;

2136 EQU972..x3C408 - x3C405 =e= 0;

2137 EQU973..x4C408 - x4C405 =e= 0;

2138 EQU974..x5C408 - x5C405 =e= 0;

2139 EQU975..xM1C606D \* FC426\*\*2 \*(Sm1C606D-1)=e= FC405 \* x1C405 \* (FC428\*Kp1C606D\*(Sm1C606D\*\*(13-1)-1) + FC426\*(Sm1C606D-1));

2140 EQU976..h5C606A\*LpC606A\*(1-Sm5C606A)=e= FC322\*(1-Sn5C606A);

2141 EQU977..h7C606A\*LpC606A\*(1-Sm7C606A)=e= FC322\*(1-Sn7C606A);

2142 EQU978..FC404 \* x1C404 + FC432\*x1C432 + FC322\*x1C322 - FC414 \* x1C414 - FC430\*x1C430 =e= 0;

2143 EQU979..FC404 \* x3C404 + FC432\*x3C432 + FC322\*x3C322 - FC414 \* x3C414 - FC430\*x3C430 =e= 0;

2144 EQU980..FC404 \* x4C404 + FC432\*x4C432 + FC322\*x4C322 - FC414 \* x4C414 - FC430\*x4C430 =e= 0;

2145 EQU981..FC404 \* x5C404 + FC432\*x5C432 + FC322\*x5C322 - FC414 \* x5C414 - FC430\*x5C430 =e= 0;

2146 EQU982..qS1C606A\*(FC404 \* x1C404 + FC432\*x1C432 + FC322\*x1C322) =e= FC322\*x1C322;

2147 EQU983..qS3C606A\*(FC404 \* x3C404 + FC432\*x3C432 + FC322\*x3C322) =e= FC322\*x3C322;

2148 EQU984..qS5C606A\*(FC404 \* x5C404 + FC432\*x5C432 + FC322\*x5C322) =e= FC322\*x5C322;

2149 EQU985..qS4C606A\*(FC404 \* x4C404 + FC432\*x4C432 + FC322\*x4C322) =e= FC322\*x4C322;

2150 EQU986..xAC02 \* (2\* x11AC02/98.08 + (1-x11AC02)/360)\*98.08 - x11AC02 =e= 0;

2151 EQU987..hAC02\*(80.06\*xAC02 + 360\*(1-xAC02))/1E2 - FAC02 \* 4.184E3 \* (-145.8407 \* x11AC02 /1E2 + 9.739e-03 \* (TAC02-273) /1E2 + 8.024e-03 \* (TAC02-273) \* x11AC02 /1E2 + 83.615 \* x11AC02 \* x11AC02 /1E2 + 65.3921/1E2) =e= 0;

2152 EQU988..xAC05 \* (2\* x11AC05/98.08 + (1-x11AC05)/360) - x11AC05/98.08 =e= 0;

2153 EQU989..hAC05\*(80.06\*xAC05 + 360\*(1-xAC05))/1E2 - FAC05 \* 4.184E3 \* (-145.8407 \* x11AC05 /1E2 + 9.739e-03 \* (TAC05-273) /1E2 + 8.024e-03 \* (TAC05-273) \* x11AC05 /1E2 + 83.615 \* x11AC05 \* x11AC05 /1E2 + 65.3921/1E2) =e= 0;

2154 EQU990..hAC07\*(80.06\*xAC07 + 360\*(1-xAC07))/1E2 - FAC07 \* 4.184E3 \* (-145.8407 \* x11AC07 /1E2 + 9.739e-03 \* (TAC07-273) /1E2 + 8.024e-03 \* (TAC07-273) \* x11AC07 /1E2 + 83.615 \* x11AC07 \* x11AC07 /1E2 + 65.3921/1E2) =e= 0;

2155 EQU991..xAC07 \* (2\* x11AC07/98.08 + (1-x11AC07)/360) - x11AC07/98.08 =e= 0;

\_Economic Optimization Program 05/15/01 16:49:39 PAGE 50

GAMS 2.50A Windows NT/95/98

2156 EQU992..hAC09 - FAC09 \* ((x1AC09/MW1) \* (SUM(Coeff,1/ORD(Coeff)) \* Enth\_liq("1",Coeff) \* POWER(TAC09,ORD(Coeff))))

2157 + (x3AC09/MW3) \* (SUM(Coeff,1/ORD(Coeff)) \* Enth\_liq("3",Coeff) \* POWER(TAC09,ORD(Coeff))))

2158 + (x4AC09/MW4) \* (SUM(Coeff,1/ORD(Coeff)) \* Enth\_liq("4",Coeff) \* POWER(TAC09,ORD(Coeff))))

2159 + (x5AC09/MW5) \* (SUM(Coeff,1/ORD(Coeff)) \* Enth\_liq("5",Coeff) \* POWER(TAC09,ORD(Coeff))))

2160 + (x7AC09/MW7) \* (SUM(Coeff,1/ORD(Coeff)) \* Enth\_liq("7",Coeff) \* POWER(TAC09,ORD(Coeff))))

2161 + (x8AC09/MW8) \* (SUM(Coeff,1/ORD(Coeff)) \* Enth\_liq("8",Coeff) \* POWER(TAC09,ORD(Coeff))))

2162 + (x9AC09/MW9) \* (SUM(Coeff,1/ORD(Coeff)) \* Enth\_liq("9",Coeff) \* POWER(TAC09,ORD(Coeff))))

2163 + 3 \* (x10AC09/MW10) \* (SUM(Coeff,1/ORD(Coeff)) \* Enth\_liq("10",Coeff) \* POWER(TAC09,ORD(Coeff)))) - hacAC09 =e= 0;

2164 EQU993..xAC09 \* (2\* x11AC09/98.08 + (1-x11AC09)/360) - x11AC09/98.08 =e= 0;

2165 EQU994..hacAC09\*(80.06\*xAC09 + 360\*(1-xAC09))/1E2 - FAC09 \* 4.184E3 \* (-145.8407 \* x11AC09 /1E2 + 9.739e-03 \* (TAC09-273) /1E2 + 8.024e-03 \* (TAC09-273) \* x11AC09 /1E2 + 83.615 \* x11AC09 \* x11AC09 /1E2 + 65.3921/1E2) =e= 0;

2166 EQU995..xAC12 \* (2\* x11AC12/98.08 + (1-x11AC12)/360) - x11AC12/98.08 =e= 0;

2167 EQU996..hAC12\*(80.06\*xAC12 + 360\*(1-xAC12))/1E2 - FAC12 \* 4.184E3 \* (-145.8407 \* x11AC12 /1E2 + 9.739e-03 \* (TAC12-273) /1E2 + 8.024e-03 \* (TAC12-273) \* x11AC12 /1E2 + 83.615 \* x11AC12 \* x11AC12 /1E2 + 65.3921/1E2) =e= 0;

2168 EQU997..hAC15\*(80.06\*xAC15 + 360\*(1-xAC15))/1E2 - FAC15 \* 4.184E3 \* (-145.8407 \* x11AC15 /1E2 + 9.739e-03 \* (TAC15-273) /1E2 + 8.024e-03 \* (TAC15-273) \* x11AC15 /1E2 + 83.615 \* x11AC15 \* x11AC15 /1E2 + 65.3921/1E2) =e= 0;

2169 EQU998..xAC15 \* (2\* x11AC15/98.08 + (1-x11AC15)/360) - x11AC15/98.08 =e= 0;

2170 EQU999..hAC18\*(80.06\*xAC18 + 360\*(1-xAC18))/1E2 - FAC18 \* 4.184E3 \* (-145.8407 \* x11AC18 /1E2 + 9.739e-03 \* (TAC18-273) /1E2 + 8.024e-03 \* (TAC18-273) \* x11AC18 /1E2 + 83.615 \* x11AC18 \* x11AC18 /1E2 + 65.3921/1E2) =e= 0;

2171 EQU1000..xAC18 \* (2\* x11AC18/98.08 + (1-x11AC18)/360) - x11AC18/98.08 =e= 0;



2172 EQU1001..hacAC20\*(80.06\*xAC20 + 360\*(1- xAC20))/1E2 - FAC20 \* 4.184E3\* (-145.8407 \* x11AC20/1E2 + 9.739e-03 \* (TAC20-273) /1E2+ 8.024e-03 \* (TAC20-273) \* x11AC20 /1E2+ 83.615 \* x11AC20 \* x11AC20 /1E2+ 65.3921/1E2) =e= 0;

2173 EQU1002..hAC20 - FAC20 \* ((x1AC20/MW1)\*(SUM(Coeff,1/ORD(Coeff) \* Enth\_liq("1",Coeff) \*POWER(TAC20,ORD(Coeff))))

2174 +(x3AC20/MW3)\*(SUM(Coeff,1/ORD(Coeff) \* Enth\_liq("3",Coeff) \* POWER(TAC20,ORD(Coeff))))

2175 +(x4AC20/MW4)\*(SUM(Coeff,1/ORD(Coeff) \* Enth\_liq("4",Coeff) \*POWER(TAC20,ORD(Coeff))))

2176 +(x5AC20/MW5)\*(SUM(Coeff,1/ORD(Coeff) \* Enth\_liq("5",Coeff) \*POWER(TAC20,ORD(Coeff))))

2177 +(x7AC20/MW7)\*(SUM(Coeff,1/ORD(Coeff) \* Enth\_liq("7",Coeff) \*POWER(TAC20,ORD(Coeff))))

2178 +(x8AC20/MW8)\*(SUM(Coeff,1/ORD(Coeff) \* Enth\_liq("8",Coeff) \* POWER(TAC20,ORD(Coeff))))

2179 +(x9AC20/MW9)\*(SUM(Coeff,1/ORD(Coeff) \* Enth\_liq("9",Coeff) \*POWER(TAC20,ORD(Coeff))))

2180 + 3 \* (x10AC20/MW10)\*(SUM(Coeff,1/ORD(Coeff) \* Enth\_liq("10",Coeff) \*POWER(TAC20,ORD(Coeff)))) - hacAC20 =e= 0;

2181 EQU1003..xAC20 \* (2\* x11AC20/98.08 + (1-x11AC20)/360) - x11AC20/98.08 =e= 0;

2182 EQU1004..hAC23\*(80.06\*xAC23 + 360\*(1- xAC23))/1E2 - FAC23 \* 4.184E3\* (-145.8407 \* x11AC23 /1E2+ 9.739e-03 \* (TAC23-273) /1E2+ 8.024e-03 \* (TAC23-273) \* x11AC23 /1E2+ 83.615 \* x11AC23 \* x11AC23 /1E2+ 65.3921/1E2) =e= 0;

2183 EQU1005..xAC23 \* (2\* x11AC23/98.08 + (1-x11AC23)/360) - x11AC23/98.08 =e= 0;

2184 EQU1006..hAC26\*(80.06\*xAC26 + 360\*(1- xAC26))/1E2 - FAC26 \* 4.184E3\* (-145.8407 \* x11AC26 /1E2+ 9.739e-03 \* (TAC26-273)/1E2 + 8.024e-03 \* (TAC26-273) \* x11AC23 /1E2+ 83.615 \* x11AC26 \* x11AC26 /1E2+ 65.3921/1E2) =e= 0;

2185 EQU1007..xAC26 \* (2\* x11AC26/98.08 + (1-x11AC26)/360) - x11AC26/98.08 =e= 0;

2186 EQU1008..hAC29\*(80.06\*xAC29 + 360\*(1- xAC29))/1E2 - FAC29 \* 4.184E3\* (-145.8407 \* x11AC29 /1E2+ 9.739e-03 \* (TAC29-273) /1E2+ 8.024e-03 \* (TAC29-273) \* x11AC29/1E2 + 83.615 \* x11AC29 \* x11AC29 /1E2+ 65.3921/1E2) =e= 0;

2187 EQU1009..xAC29 \* (2\* x11AC29/98.08 + (1-x11AC29)/360) - x11AC29/98.08 =e= 0;

2188 EQU1010..hacAC31\*(80.06\*xAC31 + 360\*(1- xAC31))/1E2 - FAC31 \* 4.184E3\* (-145.8407 \* x11AC31/1E2 + 9.739e-03 \* (TAC31-273) /1E2+ 8.024e-03 \* (TAC31-273) \* x11AC31/1E2 + 83.615 \* x11AC31 \* x11AC31/1E2 + 65.3921/1E2) =e= 0;

2189 EQU1011..hAC31 - FAC31 \* ((x1AC31/MW1)\*(SUM(Coeff,1/ORD(Coeff) \* Enth\_liq("1",Coeff) \*POWER(TAC31,ORD(Coeff))))

2190 +(x3AC31/MW3)\*(SUM(Coeff,1/ORD(Coeff) \* Enth\_liq("3",Coeff) \* POWER(TAC31,ORD(Coeff))))

2191 +(x4AC31/MW4)\*(SUM(Coeff,1/ORD(Coeff) \* Enth\_liq("4",Coeff) \*POWER(TAC31,ORD(Coeff))))

2192 +(x5AC31/MW5)\*(SUM(Coeff,1/ORD(Coeff) \* Enth\_liq("5",Coeff) \*POWER(TAC31,ORD(Coeff))))

\_Economic Optimization Program 05/15/01 16:49:39 PAGE 51

2193 +(x7AC31/MW7)\*(SUM(Coeff,1/ORD(Coeff) \* Enth\_liq("7",Coeff) \*POWER(TAC31,ORD(Coeff))))

2194 +(x8AC31/MW8)\*(SUM(Coeff,1/ORD(Coeff) \* Enth\_liq("8",Coeff) \*POWER(TAC31,ORD(Coeff))))

2195 +(x9AC31/MW9)\*(SUM(Coeff,1/ORD(Coeff) \* Enth\_liq("9",Coeff) \*POWER(TAC31,ORD(Coeff))))

2196 + 3 \* (x10AC31/MW10)\*(SUM(Coeff,1/ORD(Coeff) \* Enth\_liq("10",Coeff) \*POWER(TAC31,ORD(Coeff)))) - hacAC31 =e= 0;

2197 EQU1012..xAC31 \* (2\* x11AC31/98.08 + (1-x11AC31)/360) - x11AC31/98.08 =e= 0;

2198 EQU1013..hAC34\*(80.06\*xAC34 + 360\*(1- xAC34))/1E2 - FAC34 \* 4.184E3\* (-145.8407 \* x11AC34 /1E2+ 9.739e-03 \* (TAC34-273) /1E2+ 8.024e-03 \* (TAC34-273) \* x11AC34/1E2 + 83.615 \* x11AC34 \* x11AC34 /1E2+ 65.3921/1E2) =e= 0;

2199 EQU1014..xAC34 \* (2\* x11AC34/98.08 + (1-x11AC34)/360) - x11AC34/98.08 =e= 0;

2200 EQU1015..qS7C606A\*(FC404 \* x7C404 + FC432\*x7C432 + FC322\*x7C322) =e= FC322\*x7C322;

2201 EQU1016..qFp1C606A\*(FC404 \* x1C404 + FC432\*x1C432 + FC322\*x1C322) =e= FC432\*x1C432;

2202 EQU1017..qFp3C606A\*(FC404 \* x3C404 + FC432\*x3C432 + FC322\*x3C322) =e= FC432\*x3C432;

2203 EQU1018..xM3C606D \* FC426\*\*2 \* (Sm3C606D-1)=e= FC405 \* x3C405 \* (FC428\*Kp3C606D\*(Sm3C606D\*\*((13-1)-1) + FC426\*(Sm3C606D-1)));

2204 EQU1019..FmC409 - FC409 \* (x1C409/MW1 + x3C409/MW3 + x4C409/MW4 + x5C409/MW5 + x7C409/MW7)=e= 0;

2205 EQU1020..xx4C409 \* FmC409 \* MW4 - FC409 \* x4C409 =e= 0;

2206 EQU1021..FmC408 - FC408 \* (x1C408/MW1 + x3C408/MW3 + x4C408/MW4 + x5C408/MW5 + x7C408/MW7)=e= 0;

2207 EQU1022..xx1C408 \* FmC408 \* MW1 - FC408 \* x1C408 =e= 0;

2208 EQU1023..xx3C408 \* FmC408 \* MW3 - FC408 \* x3C408 =e= 0;

2209 EQU1024..xx4C408 \* FmC408 \* MW4 - FC408 \* x4C408 =e= 0;

2210 EQU1025..xx5C408 \* FmC408 \* MW5 - FC408 \* x5C408 =e= 0;

2211 EQU1026..xx1C408 + xx3C408 + xx4C408 + xx5C408 + xx7C408 =e= 1;

2212 EQU1027..FmC405 - FC405 \* (x1C405/MW1 + x3C405/MW3 + x4C405/MW4 + x5C405/MW5 + x7C405/MW7)=e= 0;

2213 EQU1028..xx1C405 \* FmC405 \* MW1 - FC405 \* x1C405 =e= 0;

2214 EQU1029..xx3C405 \* FmC405 \* MW3 - FC405 \* x3C405 =e= 0;

2215 EQU1030..xx4C405 \* FmC405 \* MW4 - FC405 \* x4C405 =e= 0;

2216 EQU1031..xx5C405 \* FmC405 \* MW5 - FC405 \* x5C405 =e= 0;

2217 EQU1032..xx7C405 \* FmC405 \* MW7 - FC405 \* x7C405 =e= 0;

2218 EQU1033..FC427 - FC428 - FC411 =e= 0;

2219 EQU1034..hAC37\*(80.06\*xAC37 + 360\*(1- xAC37))/1E2 - FAC37 \* 4.184E3\* (-145.8407 \* x11AC37/1E2 + 9.739e-03 \* (TAC37-273)/1E2 + 8.024e-03 \* (TAC37-273) \* x11AC37 /1E2+ 83.615 \* x11AC37 \* x11AC37/1E2 + 65.3921/1E2) =e= 0;

2220 EQU1035..xAC37 \* (2\* x11AC37/98.08 + (1-x11AC37)/360) - x11AC37/98.08 =e= 0;

2221 EQU1036..hAC40\*(80.06\*xAC40 + 360\*(1- xAC40))/1E2 - FAC40 \* 4.184E3\* (-145.8407 \* x11AC40 /1E2+ 9.739e-03 \* (TAC40-273)/1E2 + 8.024e-03 \* (TAC40-273) \* x11AC40/1E2 + 83.615 \* x11AC40 \* x11AC40/1E2 + 65.3921/1E2) =e= 0;

2222 EQU1037..hacAC42\*(80.06\*xAC42 + 360\*(1- xAC42))/1E2 - FAC42 \* 4.184E3\* (-145.8407 \* x11AC42/1E2 + 9.739e-03 \* (TAC42-273)/1E2 + 8.024e-03 \* (TAC42-273) \* x11AC42/1E2 + 83.615 \* x11AC42 \* x11AC42/1E2 + 65.3921/1E2) =e= 0;

2223 EQU1038..xAC40 \* (2\* x11AC40/98.08 + (1-x11AC40)/360) - x11AC40/98.08 =e= 0;

2224 EQU1039..xAC42 \* (2\* x11AC42/98.08 + (1-x11AC42)/360) - x11AC42/98.08 =e= 0;

2225 EQU1040..hAC42 - FAC42 \* ((x1AC42/MW1)\*(SUM(Coeff,1/ORD(Coeff) \* Enth\_liq("1",Coeff) \*POWER(TAC42,ORD(Coeff))))

2226 +(x3AC42/MW3)\*(SUM(Coeff,1/ORD(Coeff) \* Enth\_liq("3",Coeff) \* POWER(TAC42,ORD(Coeff))))

2227 +(x4AC42/MW4)\*(SUM(Coeff,1/ORD(Coeff) \* Enth\_liq("4",Coeff) \*POWER(TAC42,ORD(Coeff))))

2228 +(x5AC42/MW5)\*(SUM(Coeff,1/ORD(Coeff) \* Enth\_liq("5",Coeff) \*POWER(TAC42,ORD(Coeff))))

2229 +(x7AC42/MW7)\*(SUM(Coeff,1/ORD(Coeff) \* Enth\_liq("7",Coeff) \*POWER(TAC42,ORD(Coeff))))

2230 +(x8AC42/MW8)\*(SUM(Coeff,1/ORD(Coeff) \* Enth\_liq("8",Coeff) \*POWER(TAC42,ORD(Coeff))))

2231 +(x9AC42/MW9)\*(SUM(Coeff,1/ORD(Coeff) \* Enth\_liq("9",Coeff) \*POWER(TAC42,ORD(Coeff))))

2232 + 3 \* (x10AC42/MW10)\*(SUM(Coeff,1/ORD(Coeff) \* Enth\_liq("10",Coeff) \*POWER(TAC42,ORD(Coeff)))) - hacAC42 =e= 0;

2233 EQU1041..x1HC28 -x1HC29 =e= 0;

2234 EQU1042..x2HC28 -x2HC29 =e= 0;

\_Economic Optimization Program 05/15/01 16:49:39 PAGE 52

2235 EQU1043..x3HC28 -x3HC29 =e= 0;

2236 EQU1044..x4HC28 -x4HC29 =e= 0;

2237 EQU1045..x5HC28 -x5HC29 =e= 0;

2238 EQU1046..x1HC28 -x1R1 =e= 0;

2239 EQU1047..x2HC28 -x2R1 =e= 0;

2240 EQU1048..x3HC28 -x3R1 =e= 0;

2241 EQU1049..x4HC28 -x4R1 =e= 0;

2242 EQU1050..x5HC28 -x5R1 =e= 0;

2243 EQU1051..y1HC28 -y1HC29 =e= 0;

2244 EQU1052..y2HC28 -y2HC29 =e= 0;

2245 EQU1053..y3HC28 -y3HC29 =e= 0;

2246 EQU1054..y4HC28 -y4HC29 =e= 0;

```

2247 EQU1055..y5HC28 -y5HC29 =e= 0;
2248 EQU1056..y1HC28 -y1R1 =e= 0;
2249 EQU1057..y2HC28 -y2R1 =e= 0;
2250 EQU1058..y3HC28 -y3R1 =e= 0;
2251 EQU1059..y4HC28 -y4R1 =e= 0;
2252 EQU1060..TC425 - TC410 =e= 0;
2253 EQU1061..TC425 - TC426 =e= 0;
2254 EQU1062..TC432 - TC431 =e= 0;
2255 EQU1063..TC431 - TC412 =e= 0;
2256 EQU1064..y5HC28 -y5R1 =e= 0;
2257 EQU1065..THC28 -TR1 =e= 0;
2258 EQU1066..THC28 -THC29 =e= 0;
2259 EQU1067..x1HC29 + x2HC29 + x3HC29 + x4HC29 + x5HC29 + x7HC29 =e= 1;
2260 EQU1068..y1HC29 + y2HC29 + y3HC29 + y4HC29 + y5HC29 + y7HC29 =e= 1;
2261 EQU1069..fvHC30 - FvHC30*((y1HC30/MW1)*(SUM(Coeff,1/ORD(Coeff)* Enth_liq("1",Coeff)*POWER(THC30,ORD(Coeff)))+ Enth_Vap("1",
"a1")*1000*((1-THC30/Enth_Vap("1","a2"))**Enth_Vap("1","a3"))))
2262 +(y3HC30/MW3)*(SUM(Coeff,1/ORD(Coeff)* Enth_liq("3",Coeff)* POWER(THC30,ORD(Coeff)))+ Enth_Vap("3","a1")*1000*
((1-THC30/Enth_Vap("3","a2"))**Enth_Vap("3","a3")))
2263 +(y4HC30/MW4)*(SUM(Coeff,1/ORD(Coeff)* Enth_liq("4",Coeff)*POWER(THC30,ORD(Coeff)))+ Enth_Vap("4","a1")*1000*
((1-THC30/Enth_Vap("4","a2"))**Enth_Vap("4","a3")))
2264 +(y5HC30/MW5)*(SUM(Coeff,1/ORD(Coeff)* Enth_liq("5",Coeff)*POWER(THC30,ORD(Coeff)))+ Enth_Vap("5","a1")*1000*
((1-THC30/Enth_Vap("5","a2"))**Enth_Vap("5","a3")))
2265 +(y7HC30/MW7)*(SUM(Coeff,1/ORD(Coeff)* Enth_liq("7",Coeff)*POWER(THC30,ORD(Coeff)))+ Enth_Vap("7","a1")*1000*
((1-THC30/Enth_Vap("7","a2"))**Enth_Vap("7","a3"))) =e= 0;
2266 EQU1070..hHC30 - hHC30 - hvHC30 =e= 0;
2267 EQU1071..FHC30 - FIHC30 - FvHC30 =e= 0;
2268 EQU1072..hHC30 - FIHC30*((x1HC30/MW1)*(SUM(Coeff,1/ORD(Coeff)* Enth_liq("1",Coeff)*POWER(THC30,ORD(Coeff)))+
2269 +(x3HC30/MW3)*(SUM(Coeff,1/ORD(Coeff)* Enth_liq("3",Coeff)* POWER(THC30,ORD(Coeff)))+
2270 +(x4HC30/MW4)*(SUM(Coeff,1/ORD(Coeff)* Enth_liq("4",Coeff)* POWER(THC30,ORD(Coeff)))+
2271 +(x5HC30/MW5)*(SUM(Coeff,1/ORD(Coeff)* Enth_liq("5",Coeff)*POWER(THC30,ORD(Coeff)))+
2272 +(x7HC30/MW7)*(SUM(Coeff,1/ORD(Coeff)* Enth_liq("7",Coeff)*POWER(THC30,ORD(Coeff))))) =e= 0;
2273 EQU1073..x1HC30 + x2HC30 + x3HC30 + x4HC30 + x5HC30 + x7HC30 =e= 1;
2274 EQU1074..y1HC30 + y2HC30 + y3HC30 + y4HC30 + y5HC30 + y7HC30 =e= 1;
2275 EQU1075..hvr29 - Fvr29*((y1R1/MW1)*(SUM(Coeff,1/ORD(Coeff)* Enth_liq("1",Coeff)*POWER(TR29,ORD(Coeff)))+ Enth_Vap("1","a1")
_Economic Optimization Program
05/15/01 16:49:39 PAGE 53
GAMS 2.50A Windows NT/95/98

*1000*((1-TR29/Enth_Vap("1","a2"))**Enth_Vap("1","a3"))
2276 +(y3R29/MW3)*(SUM(Coeff,1/ORD(Coeff)* Enth_liq("3",Coeff)* POWER(TR29,ORD(Coeff)))+ Enth_Vap("3","a1")*1000*((1-TR29/Enth_V
ap("3","a2"))**Enth_Vap("3","a3")))
2277 +(y4R29/MW4)*(SUM(Coeff,1/ORD(Coeff)* Enth_liq("4",Coeff)*POWER(TR29,ORD(Coeff)))+ Enth_Vap("4","a1")*1000*((1-TR29/Enth_Va
p("4","a2"))**Enth_Vap("4","a3")))
2278 +(y5R29/MW5)*(SUM(Coeff,1/ORD(Coeff)* Enth_liq("5",Coeff)*POWER(TR29,ORD(Coeff)))+ Enth_Vap("5","a1")*1000*((1-TR29/Enth_Va
p("5","a2"))**Enth_Vap("5","a3")))
2279 +(y7R29/MW7)*(SUM(Coeff,1/ORD(Coeff)* Enth_liq("7",Coeff)*POWER(TR29,ORD(Coeff)))+ Enth_Vap("7","a1")*1000*((1-TR29/Enth_Va
p("7","a2"))**Enth_Vap("7","a3"))) =e= 0;
2280 EQU1076..y1R29 + y2R29 + y3R29 + y4R29 + y5R29 + y7R29 =e= 1;
2281 EQU1077..hR29 - FIR29*((x1R29/MW1)*(SUM(Coeff,1/ORD(Coeff)* Enth_liq("1",Coeff)*POWER(TR29,ORD(Coeff)))+
2282 +(x3R29/MW3)*(SUM(Coeff,1/ORD(Coeff)* Enth_liq("3",Coeff)* POWER(TR29,ORD(Coeff)))+
2283 +(x4R29/MW4)*(SUM(Coeff,1/ORD(Coeff)* Enth_liq("4",Coeff)*POWER(TR29,ORD(Coeff)))+
2284 +(x5R29/MW5)*(SUM(Coeff,1/ORD(Coeff)* Enth_liq("5",Coeff)*POWER(TR29,ORD(Coeff)))+
2285 +(x7R29/MW7)*(SUM(Coeff,1/ORD(Coeff)* Enth_liq("7",Coeff)*POWER(TR29,ORD(Coeff))))) =e= 0;
2286 EQU1078..x1R29 + x2R29 + x3R29 + x4R29 + x5R29 + x7R29 =e= 1;
2287 EQU1079..hR29 - hR29 - hvR29 =e= 0;
2288 EQU1080..FR29 - FIR29 -Fvr29 =e= 0;
2289 EQU1081..hvHC31 - FvHC31*((y1HC31/MW1)*(SUM(Coeff,1/ORD(Coeff)* Enth_liq("1",Coeff)*POWER(THC31,ORD(Coeff)))+ Enth_Vap("1",
"a1")*1000*((1-THC31/Enth_Vap("1","a2"))**Enth_Vap("1","a3")))
2290 +(y3HC31/MW3)*(SUM(Coeff,1/ORD(Coeff)* Enth_liq("3",Coeff)* POWER(THC31,ORD(Coeff)))+ Enth_Vap("3","a1")*1000*
((1-THC31/Enth_Vap("3","a2"))**Enth_Vap("3","a3")))
2291 +(y4HC31/MW4)*(SUM(Coeff,1/ORD(Coeff)* Enth_liq("4",Coeff)*POWER(THC31,ORD(Coeff)))+ Enth_Vap("4","a1")*1000*
((1-THC31/Enth_Vap("4","a2"))**Enth_Vap("4","a3")))
2292 +(y5HC31/MW5)*(SUM(Coeff,1/ORD(Coeff)* Enth_liq("5",Coeff)*POWER(THC31,ORD(Coeff)))+ Enth_Vap("5","a1")*1000*
((1-THC31/Enth_Vap("5","a2"))**Enth_Vap("5","a3")))
2293 +(y7HC31/MW7)*(SUM(Coeff,1/ORD(Coeff)* Enth_liq("7",Coeff)*POWER(THC31,ORD(Coeff)))+ Enth_Vap("7","a1")*1000*
((1-THC31/Enth_Vap("7","a2"))**Enth_Vap("7","a3"))) =e= 0;
2294 EQU1082..hHC31 - hHC31 - hvHC31 =e= 0;
2295 EQU1083..FHC31 - FIHC31 - FvHC31 =e= 0;
2296 EQU1084..hHC31 - FIHC31*((x1HC31/MW1)*(SUM(Coeff,1/ORD(Coeff)* Enth_liq("1",Coeff)*POWER(THC31,ORD(Coeff)))+
2297 +(x3HC31/MW3)*(SUM(Coeff,1/ORD(Coeff)* Enth_liq("3",Coeff)* POWER(THC31,ORD(Coeff)))+
2298 +(x4HC31/MW4)*(SUM(Coeff,1/ORD(Coeff)* Enth_liq("4",Coeff)*POWER(THC31,ORD(Coeff)))+
2299 +(x5HC31/MW5)*(SUM(Coeff,1/ORD(Coeff)* Enth_liq("5",Coeff)*POWER(THC31,ORD(Coeff)))+
2300 +(x7HC31/MW7)*(SUM(Coeff,1/ORD(Coeff)* Enth_liq("7",Coeff)*POWER(THC31,ORD(Coeff))))) =e= 0;
2301 EQU1085..x1HC31 + x2HC31 + x3HC31 + x4HC31 + x5HC31 + x7HC31 =e= 1;
2302 EQU1086..y1HC31 + y2HC31 + y3HC31 + y4HC31 + y5HC31 + y7HC31 =e= 1;
2303 EQU1087..qFp4C606A*(FC404*x4C404 + FC432*x4C432 + FC322*x4C322) =e= FC432*x4C432;
2304 EQU1088..qFp5C606A*(FC404*x5C404 + FC432*x5C432 + FC322*x5C322) =e= FC432*x5C432;
2305 EQU1089..qFp7C606A*(FC404*x7C404 + FC432*x7C432 + FC322*x7C322) =e= FC432*x7C432;
2306 EQU1090..K1C430*PC606A =e= 0.1333*10**(21.4469-1.4627E3/TC430-5.261*LOG10(TC430)+3.282E-11*TC430+3.7349E-6*TC430**2);
2307 EQU1091..K3C430*PC606A =e= 0.1333*10**(31.2541-1.9532E3/TC430-8.806*LOG10(TC430)+8.9246E-11*TC430+5.7501E-6*TC430**2);
2308 EQU1092..K4C430*PC606A =e= 0.1333*10**(27.0441-1.9049E3/TC430-7.1805*LOG10(TC430)-6.6845E-11*TC430+4.219E-6*TC430**2);
2309 EQU1093..K5C430*PC606A =e= 0.1333*10**(29.2963-2.1762E3/TC430-7.883*LOG10(TC430)-4.6512E-11*TC430+3.8997E-6*TC430**2);
2310 EQU1094..K7C430*PC606A =e= 0.1333*10**(33.0162-2.583E3/TC430-9.042*LOG10(TC430)-1.371E-12*TC430+3.634E-6*TC430**2);
2311 EQU1095..K1C430**xx1C430+K3C430**xx3C430+K4C430**xx4C430+K5C430**xx5C430+K7C430**xx7C430 =e= 1;
_Economic Optimization Program
05/15/01 16:49:39 PAGE 54
GAMS 2.50A Windows NT/95/98

2312 EQU1096..xx1C430+xx3C430+xx4C430+xx5C430+xx7C430 =e= 1;
2313 EQU1097..xx1C430 * FmC430 * MW1 - FC430 * x1C430 =e= 0;
2314 EQU1098..xx5C430 * FmC430 * MW5 - FC430 * x5C430 =e= 0;
2315 EQU1099..xx1C414+xx3C414+xx4C414+xx5C414+xx7C414 =e= 1;

```

2316 EQU1100..K1C414\*PC606A =e= 0.1333\*10\*\*(21.4469-1.4627E3/TC414-5.261\*LOG10(TC414)+3.282E-11\*TC414+3.7349E-6\*TC414\*\*2);  
2317 EQU1101..K3C414\*PC606A =e= 0.1333\*10\*\*(31.2541-1.9532E3/TC414-8.806\*LOG10(TC414)+8.9246E-11\*TC414+5.7501E-6\*TC414\*\*2);  
2318 EQU1102..K4C414\*PC606A =e= 0.1333\*10\*\*(27.0441-1.9049E3/TC414-7.1805\*LOG10(TC414)-6.6845E-11\*TC414+4.219E-6\*TC414\*\*2);  
2319 EQU1103..K5C414\*PC606A =e= 0.1333\*10\*\*(29.2963-2.1762E3/TC414-7.883\*LOG10(TC414)-4.6512E-11\*TC414+3.8997E-6\*TC414\*\*2);  
2320 EQU1104..K7C414\*PC606A =e= 0.1333\*10\*\*(33.0162-2.583E3/TC414-9.042\*LOG10(TC414)-1.371E-12\*TC414+3.634E-6\*TC414\*\*2);  
2321 EQU1105..xx1C414/K1C414+xx3C414/K3C414+xx4C414/K4C414+xx5C414/K5C414+xx7C414/K7C414 =e= 1;  
2322 EQU1106..xx1C414 \* FmC414 \* MW1 - FC414 \* x1C414 =e= 0;  
2323 EQU1107..xx4C414 \* FmC414 \* MW4 - FC414 \* x4C414 =e= 0;  
2324 EQU1108..xx7C414 \* FmC414 \* MW7 - FC414 \* x7C414 =e= 0;  
2325 EQU1109..FC425 - FC430 =e=0;  
2326 EQU1110..x1C431 + x3C431 + x4C431 + x5C431 + x7C431 =e= 1;  
2327 EQU1111..FmC431 - FC431 \* (x1C431/MW1 + x3C431/MW3 + x4C431/MW4 + x5C431/MW5 + x7C431/MW7)=e= 0;  
2328 EQU1112..xx4C431 \* FmC431 \* MW4 - FC431 \* x4C431 =e= 0;  
2329 EQU1113..xx1C425\*K1C606C =e= xx1C431;  
2330 EQU1114..xx3C425\*K3C606C =e= xx3C431;  
2331 EQU1115..xx4C425\*K4C606C =e= xx4C431;  
2332 EQU1116..xx5C425\*K5C606C =e= xx5C431;  
2333 EQU1117..xx1C431 \* FmC431 \* MW1 - FC431 \* x1C431 =e= 0;  
2334 EQU1118..xx3C431 \* FmC431 \* MW3 - FC431 \* x3C431 =e= 0;  
2335 EQU1119..xx5C431 \* FmC431 \* MW5 - FC431 \* x5C431 =e= 0;  
2336 EQU1120..xx1C431+ xx3C431+ xx4C431+ xx5C431+ xx7C431 =e= 1;  
2337 EQU1121..xx1C425 \* FmC425 \* MW1 - FC425 \* x1C425 =e= 0;  
2338 EQU1122..xx3C425 \* FmC425 \* MW3 - FC425 \* x3C425 =e= 0;  
2339 EQU1123..xx5C425 \* FmC425 \* MW5 - FC425 \* x5C425 =e= 0;  
2340 EQU1124..xx1C425 + xx3C425 +xx4C425 +xx5C425 +xx7C425 =e=1 ;  
2341 EQU1125..K1C606C\*PC606C =e= 0.1333\*10\*\*(21.4469-1.4627E3/TC425-5.261\*LOG10(TC425)+3.282E-11\*TC425+3.7349E-6\*TC425\*\*2);  
2342 EQU1126..K3C606C\*PC606C =e= 0.1333\*10\*\*(31.2541-1.9532E3/TC425-8.806\*LOG10(TC425)+8.9246E-11\*TC425+5.7501E-6\*TC425\*\*2);  
2343 EQU1127..K4C606C\*PC606C =e= 0.1333\*10\*\*(27.0441-1.9049E3/TC425-7.1805\*LOG10(TC425)-6.6845E-11\*TC425+4.219E-6\*TC425\*\*2);  
2344 EQU1128..K5C606C\*PC606C =e= 0.1333\*10\*\*(29.2963-2.1762E3/TC425-7.883\*LOG10(TC425)-4.6512E-11\*TC425+3.8997E-6\*TC425\*\*2);  
2345 EQU1129..xM4C606D \* FC426\*\*2 \*(Sm4C606D-1)=e= FC405 \* x4C405 \* (FC428\*Kp4C606D\*(Sm4C606D\*\*(13-1)-1) + FC426\*(Sm4C606D-1));  
2346 EQU1130..xM5C606D \* FC426\*\*2 \*(Sm5C606D-1)=e= FC405 \* x5C405 \* (FC428\*Kp5C606D\*(Sm5C606D\*\*(13-1)-1) + FC426\*(Sm5C606D-1));  
2347 EQU1131..xM7C606D \* FC426\*\*2 \*(Sm7C606D-1)=e= FC405 \* x7C405 \* (FC428\*Kp7C606D\*(Sm7C606D\*\*(13-1)-1) + FC426\*(Sm7C606D-1));  
2348 EQU1132..xM1C606D + xM3C606D + xM4C606D + xM5C606D + xM7C606D =e=1;  
2349 EQU1133..xx3C428 \* FmC428 \* MW3 - FC428 \* x3C428 =e= 0;  
2350 EQU1134..xx1C428 \* FmC428 \* MW1 - FC428 \* x1C428 =e= 0;  
2351 EQU1135..xx5C428 \* FmC428 \* MW5 - FC428 \* x5C428 =e= 0;  
2352 EQU1136..xx1C428 + xx3C428 + xx4C428 + xx5C428 + xx7C428 =e=1;  
2353 EQU1137..K1C428\*PC606D =e= 0.1333\*10\*\*(21.4469-1.4627E3/TC428-5.261\*LOG10(TC428)+3.282E-11\*TC428+3.7349E-6\*TC428\*\*2);  
2354 EQU1138..K3C428\*PC606D =e= 0.1333\*10\*\*(31.2541-1.9532E3/TC428-8.806\*LOG10(TC428)+8.9246E-11\*TC428+5.7501E-6\*TC428\*\*2);  
2355 EQU1139..K4C428\*PC606D =e= 0.1333\*10\*\*(27.0441-1.9049E3/TC428-7.1805\*LOG10(TC428)-6.6845E-11\*TC428+4.219E-6\*TC428\*\*2);  
2356 EQU1140..K5C428\*PC606D =e= 0.1333\*10\*\*(29.2963-2.1762E3/TC428-7.883\*LOG10(TC428)-4.6512E-11\*TC428+3.8997E-6\*TC428\*\*2);  
2357 EQU1141..K7C428\*PC606D =e= 0.1333\*10\*\*(33.0162-2.583E3/TC428-9.042\*LOG10(TC428)-1.371E-12\*TC428+3.634E-6\*TC428\*\*2);  
\_Economic Optimization Program  
05/15/01 16:49:39 PAGE 55  
GAMS 2.50A Windows NT/95/98

2358 EQU1142..xM1C606D\*K1C428 =e= xx1C428;  
2359 EQU1143..xM3C606D\*K3C428 =e= xx3C428;  
2360 EQU1144..xM4C606D\*K4C428 =e= xx4C428;  
2361 EQU1145..xM5C606D\*K5C428 =e= xx5C428;  
2362 EQU1146..Kp1C606D\*PC606D =e= 0.1333\*10\*\*(21.4469-1.4627E3/TmC606D-5.261\*LOG10(TmC606D)+3.282E-11\*TmC606D+3.7349E-6\*TmC606D\*\*2);  
2363 EQU1147..Kp3C606D\*PC606D =e= 0.1333\*10\*\*(31.2541-1.9532E3/TmC606D-8.806\*LOG10(TmC606D)+8.9246E-11\*TmC606D+5.7501E-6\*TmC606D\*\*2);  
2364 EQU1148..Kp4C606D\*PC606D =e= 0.1333\*10\*\*(27.0441-1.9049E3/TmC606D-7.1805\*LOG10(TmC606D)-6.6845E-11\*TmC606D+4.219E-6\*TmC606D\*\*2);  
2365 EQU1149..Kp5C606D\*PC606D =e= 0.1333\*10\*\*(29.2963-2.1762E3/TmC606D-7.883\*LOG10(TmC606D)-4.6512E-11\*TmC606D+3.8997E-6\*TmC606D\*\*2);  
2366 EQU1150..Kp7C606D\*PC606D =e= 0.1333\*10\*\*(33.0162-2.583E3/TmC606D-9.042\*LOG10(TmC606D)-1.371E-12\*TmC606D+3.634E-6\*TmC606D\*\*2);  
2367 EQU1151..TmC606D \* 2 =e= TC428 + TC405;  
2368 EQU1152..Sm1C606D\*FC426 =e= K1C428 \* FC428;  
2369 EQU1153..Sm3C606D\*FC426 =e= K3C428 \* FC428;  
2370 EQU1154..Sm4C606D\*FC426 =e= K4C428 \* FC428;  
2371 EQU1155..Sm5C606D\*FC426 =e= K5C428 \* FC428;  
2372 EQU1156..Sm7C606D\*FC426 =e= K7C428 \* FC428;  
2373 EQU1157..K1C408\*PC606D =e= 0.1333\*10\*\*(21.4469-1.4627E3/TC408-5.261\*LOG10(TC408)+3.282E-11\*TC408+3.7349E-6\*TC408\*\*2);  
2374 EQU1158..K3C408\*PC606D =e= 0.1333\*10\*\*(31.2541-1.9532E3/TC408-8.806\*LOG10(TC408)+8.9246E-11\*TC408+5.7501E-6\*TC408\*\*2);  
2375 EQU1159..K4C408\*PC606D =e= 0.1333\*10\*\*(27.0441-1.9049E3/TC408-7.1805\*LOG10(TC408)-6.6845E-11\*TC408+4.219E-6\*TC408\*\*2);  
2376 EQU1160..K2E6XX\*PR29 =e=1.05\*PE633;  
2377 EQU1161..K3E6XX\*PR29 =e= 1.25\*PE633;  
2378 EQU1162..K4E6XX\*PR29 =e=0.82\*PE633;  
2379 EQU1163..K5E6XX\*PR29 =e=0.28\*PE633;  
2380 EQU1164..K7E6XX\*PR29 =e=0.068\*PE633;  
2381 EQU1165..hC623 =e= hAC09 - hAC07 - hHC07 - hHC34 ;  
2382 EQU1166..hC625 =e= hAC20 - hAC18 - hHC11 - hHC38;  
2383 EQU1167..hC627 =e= hAC31 - hAC29 - hHC14 - hHC41;  
2384 EQU1168..hC629 =e= hAC42 - hAC40 - hHC16 - hHC45;  
2385 EQU1169..FHC30 + FR29 =e= FHC31;  
2386 EQU1170..FvHC30 + FvR29 =e= FvHC31;  
2387 EQU1171..FvHC30\*y1HC30 + FvR29\*y1R29 =e= FvHC31\*y1HC31;  
2388 EQU1172..FvHC30\*y3HC30 + FvR29\*y3R29 =e= FvHC31\*y3HC31;  
2389 EQU1173..FvHC30\*y4HC30 + FvR29\*y4R29 =e= FvHC31\*y4HC31;  
2390 EQU1174..FvHC30\*y5HC30 + FvR29\*y5R29 =e= FvHC31\*y5HC31;  
2391 EQU1175..FvHC30\*y7HC30 + FvR29\*y7R29 =e= FvHC31\*y7HC31;  
2392 EQU1176..FIHC30\*x1HC30 + FIR29\*x1R29 =e= FIHC31\*x1HC31;  
2393 EQU1177..FIHC30\*x3HC30 + FIR29\*x3R29 =e= FIHC31\*x3HC31;  
2394 EQU1178..FIHC30\*x4HC30 + FIR29\*x4R29 =e= FIHC31\*x4HC31;  
2395 EQU1179..FIHC30\*x5HC30 + FIR29\*x5R29 =e= FIHC31\*x5HC31;  
2396 EQU1180..FIHC30\*x7HC30 + FIR29\*x7R29 =e= FIHC31\*x7HC31;  
2397 EQU1181..FC301 - FvHC31 =e= 0;  
2398 EQU1182..x1C301 - y1HC31 =e=0;  
2399 EQU1183..x7C301 - y7HC31 =e=0;

2400 EQU1184..x3C301 - y3HC31 =e=0;  
2401 EQU1185..x4C301 - y4HC31 =e=0;  
2402 EQU1186..x5C301 - y5HC31 =e=0;  
2403 EQU1187..FC401 - FIHC31 =e= 0;  
2404 EQU1188..x1C401 - x1HC31 =e=0;  
2405 EQU1189..x3C401 - x3HC31 =e=0;  
2406 EQU1190..x4C401 - x4HC31 =e=0;  
2407 EQU1191..x5C401 - x5HC31 =e=0;  
2408 EQU1192..x7C401 - x7HC31 =e=0;  
2409 EQU1193..THC32 - TC302 =e= 0;  
2410 EQU1194..K4C614B=e=0.13332\*EXP(15.6782-2154.90/(TC302-34.42))/PC302;  
2411 EQU1195..PC302 -PHC32 =e= 0;  
2412 EQU1196..K5C614B=e=0.13332\*EXP(15.5338-2348.67/(TC302-40.05))/PC302;  
2413 EQU1197..K7C614B=e=0.13332\*EXP(15.7588-2633.90/(TC302-46.30))/PC302;  
2414 EQU1198..hC311-hC302-hHC32=e=0;  
2415 EQU1199..K3C614B \* xx3HC32 - xx3C302 =e= 0;  
2416 EQU1200..K1C614B \* xx1HC32 - xx1C302 =e= 0;  
2417 EQU1201..K4C614B \* xx4HC32 - xx4C302 =e= 0;  
2418 EQU1202..K5C614B \* xx5HC32 - xx5C302 =e= 0;  
2419 EQU1203..x1C426 + x3C426 + x4C426 + x5C426 + x7C426 =e= 1;  
2420 EQU1204..K5C408\*PC606D =e= 0.1333\*10\*\*(29.2963-2.1762E3/TC408-7.883\*LOG10(TC408)-4.6512E-11\*TC408+3.8997E-6\*TC408\*\*2);  
2421 EQU1205..K7C408\*PC606D =e= 0.1333\*10\*\*(33.0162-2.583E3/TC408-9.042\*LOG10(TC408)-1.371E-12\*TC408+3.634E-6\*TC408\*\*2);  
2422 EQU1206..K1C408\*xx1C408+K3C408\*xx3C408+K4C408\*xx4C408+K5C408\*xx5C408+K7C408\*xx7C408 =e= 1;  
2423 EQU1207..dTE633\*2 =e= (THC05-THC30) + (THC04-THC29);  
2424 EQU1208..xx1HC29 + xx2HC29 + xx3HC29 + xx4HC29 + xx5HC29 + xx7HC29 =e= 1;  
2425 EQU1209..yy1HC29 + yy2HC29 + yy3HC29 + yy4HC29 + yy5HC29 + yy7HC29 =e= 1;  
2426 EQU1210..FmLHC29 - FIHC29 \* (x1HC29/MW1 + x2HC29/MW2 + x3HC29/MW3 + x4HC29/MW4 + x5HC29/MW5 + x7HC29/MW7)=e= 0;  
2427 EQU1211..FmVHC29 - FvHC29 \* (y1HC29/MW1 + y2HC29/MW2 + y3HC29/MW3 + y4HC29/MW4 + y5HC29/MW5 + y7HC29/MW7)=e= 0;  
2428 EQU1212..xx1HC29 \* MW1 \* FmLHC29 - FIHC29 \* x1HC29 =e= 0;  
2429 EQU1213..xx3HC29 \* MW3 \* FmLHC29 - FIHC29 \* x3HC29 =e= 0;  
2430 EQU1214..xx4HC29 \* MW4 \* FmLHC29 - FIHC29 \* x4HC29 =e= 0;  
2431 EQU1215..xx5HC29 \* MW5 \* FmLHC29 - FIHC29 \* x5HC29 =e= 0;  
2432 EQU1216..xx7HC29 \* MW7 \* FmLHC29 - FIHC29 \* x7HC29 =e= 0;  
2433 EQU1217..yy7HC29 \* MW7 \* FmVHC29 - FvHC29 \* y7HC29 =e= 0;  
2434 EQU1218..yy5HC29 \* MW5 \* FmVHC29 - FvHC29 \* y5HC29 =e= 0;  
2435 EQU1219..yy4HC29 \* MW4 \* FmVHC29 - FvHC29 \* y4HC29 =e= 0;  
2436 EQU1220..yy3HC29 \* MW3 \* FmVHC29 - FvHC29 \* y3HC29 =e= 0;  
2437 EQU1221..yy1HC29 \* MW1 \* FmVHC29 - FvHC29 \* y1HC29 =e= 0;  
2438 EQU1222..yy7R1 \* MW7 \* FmVr1 - FvR1 \* y7R1 =e= 0;  
2439 EQU1223..yy5R1 \* MW5 \* FmVr1 - FvR1 \* y5R1 =e= 0;  
2440 EQU1224..yy4R1 \* MW4 \* FmVr1 - FvR1 \* y4R1 =e= 0;  
2441 EQU1225..yy3R1 \* MW3 \* FmVr1 - FvR1 \* y3R1 =e= 0;  
2442 EQU1226..yy1R1 \* MW1 \* FmVr1 - FvR1 \* y1R1 =e= 0;  
2443 EQU1227..xx7R1 \* MW7 \* FmIr1 - FIR1 \* x7R1 =e= 0;  
2444 EQU1228..xx5R1 \* MW5 \* FmIr1 - FIR1 \* x5R1 =e= 0;  
2445 EQU1229..xx4R1 \* MW4 \* FmIr1 - FIR1 \* x4R1 =e= 0;

2446 EQU1230..xx3R1 \* MW3 \* FmIr1 - FIR1 \* x3R1 =e= 0;  
2447 EQU1231..xx1R1 \* MW1 \* FmIr1 - FIR1 \* x1R1 =e= 0;  
2448 EQU1232..FmVr1 - FvR1 \* (y1R1/MW1 + y2R1/MW2 + y3R1/MW3 + y4R1/MW4 + y5R1/MW5 + y7R1/MW7)=e= 0;  
2449 EQU1233..FmIr1 - FIR1 \* (x1R1/MW1 + x2R1/MW2 + x3R1/MW3 + x4R1/MW4 + x5R1/MW5 + x7R1/MW7)=e= 0;  
2450 EQU1234..xx1R1 + xx2R1 + xx3R1 + xx4R1 + xx5R1 + xx7R1 =e= 1;  
2451 EQU1235..yy1R1 + yy2R1 + yy3R1 + yy4R1 + yy5R1 + yy7R1 =e= 1;  
2452 EQU1236..K1E633\*PHC30 =e= 3.71\*PE633;  
2453 EQU1237..K2E633\*PHC30 =e= 1.05\*PE633;  
2454 EQU1238..K3E633\*PHC30 =e=1.25\*PE633;  
2455 EQU1239..K4E633\*PHC30 =e=0.82\*PE633;  
2456 EQU1240..K5E633\*PHC30 =e= 0.28\*PE633;  
2457 EQU1241..K7E633\*PHC30 =e= 0.068\*PE633;  
2458 EQU1242..yy1HC30 \* MW1 \* FmVHC30 - FvHC30 \* y1HC30 =e= 0;  
2459 EQU1243..yy3HC30 \* MW3 \* FmVHC30 - FvHC30 \* y3HC30 =e= 0;  
2460 EQU1244..yy4HC30 \* MW4 \* FmVHC30 - FvHC30 \* y4HC30 =e= 0;  
2461 EQU1245..yy5HC30 \* MW5 \* FmVHC30 - FvHC30 \* y5HC30 =e= 0;  
2462 EQU1246..yy7HC30 \* MW7 \* FmVHC30 - FvHC30 \* y7HC30 =e= 0;  
2463 EQU1247..xx1HC30 \* MW1 \* FmLHC30 - FIHC30 \* x1HC30 =e= 0;  
2464 EQU1248..xx3HC30 \* MW3 \* FmLHC30 - FIHC30 \* x3HC30 =e= 0;  
2465 EQU1249..xx4HC30 \* MW4 \* FmLHC30 - FIHC30 \* x4HC30 =e= 0;  
2466 EQU1250..xx5HC30 \* MW5 \* FmLHC30 - FIHC30 \* x5HC30 =e= 0;  
2467 EQU1251..xx7HC30 \* MW7 \* FmLHC30 - FIHC30 \* x7HC30 =e= 0;  
2468 EQU1252..FmLHC30 - FIHC30 \* (x1HC30/MW1 + x2HC30/MW2 + x3HC30/MW3 + x4HC30/MW4 + x5HC30/MW5 + x7HC30/MW7)=e= 0;  
2469 EQU1253..FmVHC30 - FvHC30 \* (y1HC30/MW1 + y2HC30/MW2 + y3HC30/MW3 + y4HC30/MW4 + y5HC30/MW5 + y7HC30/MW7)=e= 0;  
2470 EQU1254..xx1HC30 + xx2HC30 + xx3HC30 + xx4HC30 + xx5HC30 + xx7HC30 =e= 1;  
2471 EQU1255..yy1HC30 + yy2HC30 + yy3HC30 + yy4HC30 + yy5HC30 + yy7HC30 =e= 1;  
2472 EQU1256..hC404 - FC404 \* ((x1C404/MW1)\*(SUM(Coeff,1/ORD(Coeff)) \* Enth\_liq("1",Coeff) \*POWER(TC404,ORD(Coeff))))  
2473 + (x3C404/MW3)\*(SUM(Coeff,1/ORD(Coeff)) \* Enth\_liq("3",Coeff) \* POWER(TC404,ORD(Coeff))))  
2474 + (x4C404/MW4)\*(SUM(Coeff,1/ORD(Coeff)) \* Enth\_liq("4",Coeff) \* POWER(TC404,ORD(Coeff))))  
2475 + (x5C404/MW5)\*(SUM(Coeff,1/ORD(Coeff)) \* Enth\_liq("5",Coeff) \* POWER(TC404,ORD(Coeff))))  
2476 + (x7C404/MW7)\*(SUM(Coeff,1/ORD(Coeff)) \* Enth\_liq("7",Coeff) \* POWER(TC404,ORD(Coeff)))) =e= 0;  
2477 EQU1257..hC405 - FC405 \* ((x1C405/MW1)\*(SUM(Coeff,1/ORD(Coeff)) \* Enth\_liq("1",Coeff) \*POWER(TC405,ORD(Coeff))))  
2478 + (x3C405/MW3)\*(SUM(Coeff,1/ORD(Coeff)) \* Enth\_liq("3",Coeff) \* POWER(TC405,ORD(Coeff))))  
2479 + (x4C405/MW4)\*(SUM(Coeff,1/ORD(Coeff)) \* Enth\_liq("4",Coeff) \* POWER(TC405,ORD(Coeff))))  
2480 + (x5C405/MW5)\*(SUM(Coeff,1/ORD(Coeff)) \* Enth\_liq("5",Coeff) \* POWER(TC405,ORD(Coeff))))  
2481 + (x7C405/MW7)\*(SUM(Coeff,1/ORD(Coeff)) \* Enth\_liq("7",Coeff) \* POWER(TC405,ORD(Coeff)))) =e= 0;  
2482 EQU1258..hC406 - FC406 \* ((x1C406/MW1)\*(SUM(Coeff,1/ORD(Coeff)) \* Enth\_liq("1",Coeff) \*POWER(TC406,ORD(Coeff))))  
2483 + (x3C406/MW3)\*(SUM(Coeff,1/ORD(Coeff)) \* Enth\_liq("3",Coeff) \* POWER(TC406,ORD(Coeff))))

2484 +(x4C406/MW4)\*(SUM(Coeff,1/ORD(Coeff)\* Enth\_liq("4",Coeff) \*POWER(TC406,ORD(Coeff))))  
 2485 +(x5C406/MW5)\*(SUM(Coeff,1/ORD(Coeff)\* Enth\_liq("5",Coeff) \*POWER(TC406,ORD(Coeff))))  
 2486 +(x7C406/MW7)\*(SUM(Coeff,1/ORD(Coeff)\* Enth\_liq("7",Coeff) \*POWER(TC406,ORD(Coeff)))) =e= 0;  
 2487 EQU1259..hc407 - FC407 \* ((x1C407/MW1)\*(SUM(Coeff,1/ORD(Coeff)\* Enth\_liq("1",Coeff) \*POWER(TC407,ORD(Coeff))))  
 2488 +(x3C407/MW3)\*(SUM(Coeff,1/ORD(Coeff)\* Enth\_liq("3",Coeff) \* POWER(TC407,ORD(Coeff))))  
 2489 +(x4C407/MW4)\*(SUM(Coeff,1/ORD(Coeff)\* Enth\_liq("4",Coeff) \*POWER(TC407,ORD(Coeff))))  
 2490 +(x5C407/MW5)\*(SUM(Coeff,1/ORD(Coeff)\* Enth\_liq("5",Coeff) \*POWER(TC407,ORD(Coeff))))  
 2491 +(x7C407/MW7)\*(SUM(Coeff,1/ORD(Coeff)\* Enth\_liq("7",Coeff) \*POWER(TC407,ORD(Coeff)))) =e= 0;  
 \_Economic Optimization Program

2492 EQU1260..hc408 - FC408 \* ((x1C408/MW1)\*(SUM(Coeff,1/ORD(Coeff)\* Enth\_liq("1",Coeff) \*POWER(TC408,ORD(Coeff))))  
 2493 +(x3C408/MW3)\*(SUM(Coeff,1/ORD(Coeff)\* Enth\_liq("3",Coeff) \* POWER(TC408,ORD(Coeff))))  
 2494 +(x4C408/MW4)\*(SUM(Coeff,1/ORD(Coeff)\* Enth\_liq("4",Coeff) \*POWER(TC408,ORD(Coeff))))  
 2495 +(x5C408/MW5)\*(SUM(Coeff,1/ORD(Coeff)\* Enth\_liq("5",Coeff) \*POWER(TC408,ORD(Coeff))))  
 2496 +(x7C408/MW7)\*(SUM(Coeff,1/ORD(Coeff)\* Enth\_liq("7",Coeff) \*POWER(TC408,ORD(Coeff)))) =e= 0;  
 2497 EQU1261..hc410 - FC410 \* ((x1C410/MW1)\*(SUM(Coeff,1/ORD(Coeff)\* Enth\_liq("1",Coeff) \*POWER(TC410,ORD(Coeff))))  
 2498 +(x3C410/MW3)\*(SUM(Coeff,1/ORD(Coeff)\* Enth\_liq("3",Coeff) \* POWER(TC410,ORD(Coeff))))  
 2499 +(x4C410/MW4)\*(SUM(Coeff,1/ORD(Coeff)\* Enth\_liq("4",Coeff) \*POWER(TC410,ORD(Coeff))))  
 2500 +(x5C410/MW5)\*(SUM(Coeff,1/ORD(Coeff)\* Enth\_liq("5",Coeff) \*POWER(TC410,ORD(Coeff))))  
 2501 +(x7C410/MW7)\*(SUM(Coeff,1/ORD(Coeff)\* Enth\_liq("7",Coeff) \*POWER(TC410,ORD(Coeff)))) =e= 0;  
 2502 EQU1262..hc413 - FC413 \* ((x1C413/MW1)\*(SUM(Coeff,1/ORD(Coeff)\* Enth\_liq("1",Coeff) \*POWER(TC413,ORD(Coeff))))  
 2503 +(x3C413/MW3)\*(SUM(Coeff,1/ORD(Coeff)\* Enth\_liq("3",Coeff) \* POWER(TC413,ORD(Coeff))))  
 2504 +(x4C413/MW4)\*(SUM(Coeff,1/ORD(Coeff)\* Enth\_liq("4",Coeff) \*POWER(TC413,ORD(Coeff))))  
 2505 +(x5C413/MW5)\*(SUM(Coeff,1/ORD(Coeff)\* Enth\_liq("5",Coeff) \*POWER(TC413,ORD(Coeff))))  
 2506 +(x7C413/MW7)\*(SUM(Coeff,1/ORD(Coeff)\* Enth\_liq("7",Coeff) \*POWER(TC413,ORD(Coeff)))) =e= 0;

2507 EQU1263..hc414 - FC414 \*  
 2508 ((x1C414/MW1)\*(SUM(Coeff,1/ORD(Coeff)\* Enth\_liq("1",Coeff) \*POWER(TC414,ORD(Coeff))))+ Enth\_Vap("1","a1")\*1000 \*  
 ((1-TC414/Enth\_Vap("1","a2"))\*Enth\_Vap("1","a3"))  
 2509 +(x3C414/MW3)\*(SUM(Coeff,1/ORD(Coeff)\* Enth\_liq("3",Coeff) \* POWER(TC414,ORD(Coeff))))+ Enth\_Vap("3","a1")\*1000 \*  
 ((1-TC414/Enth\_Vap("3","a2"))\*Enth\_Vap("3","a3"))  
 2510 +(x4C414/MW4)\*(SUM(Coeff,1/ORD(Coeff)\* Enth\_liq("4",Coeff) \*POWER(TC414,ORD(Coeff))))+ Enth\_Vap("4","a1")\*1000 \*  
 ((1-TC414/Enth\_Vap("4","a2"))\*Enth\_Vap("4","a3"))  
 2511 +(x5C414/MW5)\*(SUM(Coeff,1/ORD(Coeff)\* Enth\_liq("5",Coeff) \*POWER(TC414,ORD(Coeff))))+ Enth\_Vap("5","a1")\*1000 \*  
 ((1-TC414/Enth\_Vap("5","a2"))\*Enth\_Vap("5","a3"))  
 2512 +(x7C414/MW7)\*(SUM(Coeff,1/ORD(Coeff)\* Enth\_liq("7",Coeff) \*POWER(TC414,ORD(Coeff))))+ Enth\_Vap("7","a1")\*1000 \*  
 ((1-TC414/Enth\_Vap("7","a2"))\*Enth\_Vap("7","a3")) =e= 0;

2513 EQU1264..hc415 - FC415 \* ((x1C415/MW1)\*(SUM(Coeff,1/ORD(Coeff)\* Enth\_liq("1",Coeff) \*POWER(TC415,ORD(Coeff))))  
 2514 +(x3C415/MW3)\*(SUM(Coeff,1/ORD(Coeff)\* Enth\_liq("3",Coeff) \* POWER(TC415,ORD(Coeff))))  
 2515 +(x4C415/MW4)\*(SUM(Coeff,1/ORD(Coeff)\* Enth\_liq("4",Coeff) \*POWER(TC415,ORD(Coeff))))  
 2516 +(x5C415/MW5)\*(SUM(Coeff,1/ORD(Coeff)\* Enth\_liq("5",Coeff) \*POWER(TC415,ORD(Coeff))))  
 2517 +(x7C415/MW7)\*(SUM(Coeff,1/ORD(Coeff)\* Enth\_liq("7",Coeff) \*POWER(TC415,ORD(Coeff)))) =e= 0;  
 2518 EQU1265..hc417 - FC417 \* ((x1C417/MW1)\*(SUM(Coeff,1/ORD(Coeff)\* Enth\_liq("1",Coeff) \*POWER(TC417,ORD(Coeff))))  
 2519 +(x3C417/MW3)\*(SUM(Coeff,1/ORD(Coeff)\* Enth\_liq("3",Coeff) \* POWER(TC417,ORD(Coeff))))  
 2520 +(x4C417/MW4)\*(SUM(Coeff,1/ORD(Coeff)\* Enth\_liq("4",Coeff) \*POWER(TC417,ORD(Coeff))))  
 2521 +(x5C417/MW5)\*(SUM(Coeff,1/ORD(Coeff)\* Enth\_liq("5",Coeff) \*POWER(TC417,ORD(Coeff))))  
 2522 +(x7C417/MW7)\*(SUM(Coeff,1/ORD(Coeff)\* Enth\_liq("7",Coeff) \*POWER(TC417,ORD(Coeff)))) =e= 0;  
 2523 EQU1266..hc418 - FC418 \* ((x1C418/MW1)\*(SUM(Coeff,1/ORD(Coeff)\* Enth\_liq("1",Coeff) \*POWER(TC418,ORD(Coeff))))  
 2524 +(x3C418/MW3)\*(SUM(Coeff,1/ORD(Coeff)\* Enth\_liq("3",Coeff) \* POWER(TC418,ORD(Coeff))))  
 2525 +(x4C418/MW4)\*(SUM(Coeff,1/ORD(Coeff)\* Enth\_liq("4",Coeff) \*POWER(TC418,ORD(Coeff))))  
 2526 +(x5C418/MW5)\*(SUM(Coeff,1/ORD(Coeff)\* Enth\_liq("5",Coeff) \*POWER(TC418,ORD(Coeff))))  
 2527 +(x7C418/MW7)\*(SUM(Coeff,1/ORD(Coeff)\* Enth\_liq("7",Coeff) \*POWER(TC418,ORD(Coeff)))) =e= 0;  
 2528 EQU1267..hc419 - FC419 \* ((x1C419/MW1)\*(SUM(Coeff,1/ORD(Coeff)\* Enth\_liq("1",Coeff) \*POWER(TC419,ORD(Coeff))))  
 2529 +(x3C419/MW3)\*(SUM(Coeff,1/ORD(Coeff)\* Enth\_liq("3",Coeff) \* POWER(TC419,ORD(Coeff))))  
 2530 +(x4C419/MW4)\*(SUM(Coeff,1/ORD(Coeff)\* Enth\_liq("4",Coeff) \*POWER(TC419,ORD(Coeff))))  
 2531 +(x5C419/MW5)\*(SUM(Coeff,1/ORD(Coeff)\* Enth\_liq("5",Coeff) \*POWER(TC419,ORD(Coeff))))  
 2532 +(x7C419/MW7)\*(SUM(Coeff,1/ORD(Coeff)\* Enth\_liq("7",Coeff) \*POWER(TC419,ORD(Coeff)))) =e= 0;  
 \_Economic Optimization Program

2533 EQU1268..hc425 - FC425 \* ((x1C425/MW1)\*(SUM(Coeff,1/ORD(Coeff)\* Enth\_liq("1",Coeff) \*POWER(TC425,ORD(Coeff))))  
 2534 +(x3C425/MW3)\*(SUM(Coeff,1/ORD(Coeff)\* Enth\_liq("3",Coeff) \* POWER(TC425,ORD(Coeff))))  
 2535 +(x4C425/MW4)\*(SUM(Coeff,1/ORD(Coeff)\* Enth\_liq("4",Coeff) \*POWER(TC425,ORD(Coeff))))  
 2536 +(x5C425/MW5)\*(SUM(Coeff,1/ORD(Coeff)\* Enth\_liq("5",Coeff) \*POWER(TC425,ORD(Coeff))))  
 2537 +(x7C425/MW7)\*(SUM(Coeff,1/ORD(Coeff)\* Enth\_liq("7",Coeff) \*POWER(TC425,ORD(Coeff)))) =e= 0;  
 2538 EQU1269..hc426 - FC426 \* ((x1C426/MW1)\*(SUM(Coeff,1/ORD(Coeff)\* Enth\_liq("1",Coeff) \*POWER(TC426,ORD(Coeff))))  
 2539 +(x3C426/MW3)\*(SUM(Coeff,1/ORD(Coeff)\* Enth\_liq("3",Coeff) \* POWER(TC426,ORD(Coeff))))  
 2540 +(x4C426/MW4)\*(SUM(Coeff,1/ORD(Coeff)\* Enth\_liq("4",Coeff) \*POWER(TC426,ORD(Coeff))))  
 2541 +(x5C426/MW5)\*(SUM(Coeff,1/ORD(Coeff)\* Enth\_liq("5",Coeff) \*POWER(TC426,ORD(Coeff))))  
 2542 +(x7C426/MW7)\*(SUM(Coeff,1/ORD(Coeff)\* Enth\_liq("7",Coeff) \*POWER(TC426,ORD(Coeff)))) =e= 0;

2543 EQU1270..yy7R29 \* MW7 \* FmvR29 - FvR29 \* y7R29 =e= 0;  
 2544 EQU1271..yy5R29 \* MW5 \* FmvR29 - FvR29 \* y5R29 =e= 0;  
 2545 EQU1272..yy4R29 \* MW4 \* FmvR29 - FvR29 \* y4R29 =e= 0;  
 2546 EQU1273..yy3R29 \* MW3 \* FmvR29 - FvR29 \* y3R29 =e= 0;  
 2547 EQU1274..yy1R29 \* MW1 \* FmvR29 - FvR29 \* y1R29 =e= 0;  
 2548 EQU1275..xx7R29 \* MW7 \* FmlR29 - FIR29 \* x7R29 =e= 0;  
 2549 EQU1276..xx5R29 \* MW5 \* FmlR29 - FIR29 \* x5R29 =e= 0;  
 2550 EQU1277..xx4R29 \* MW4 \* FmlR29 - FIR29 \* x4R29 =e= 0;  
 2551 EQU1278..xx3R29 \* MW3 \* FmlR29 - FIR29 \* x3R29 =e= 0;  
 2552 EQU1279..xx1R29 \* MW1 \* FmlR29 - FIR29 \* x1R29 =e= 0;  
 2553 EQU1280..yy1R29 + yy2R29 + yy3R29 + yy4R29 + yy5R29 + yy7R29 =e= 1;  
 2554 EQU1281..xx1R29 + xx2R29 + xx3R29 + xx4R29 + xx5R29 + xx7R29 =e= 1;  
 2555 EQU1282..FmlR29 - FIR29 \* (x1R29/MW1 + x2R29/MW2 + x3R29/MW3 + x4R29/MW4 + x5R29/MW5 + x7R29/MW7)=e= 0;  
 2556 EQU1283..FmvR29 - FvR29 \* (y1R29/MW1 + y2R29/MW2 + y3R29/MW3 + y4R29/MW4 + y5R29/MW5 + y7R29/MW7)=e= 0;  
 2557 EQU1284..yy1HC30 =e= K1E633\*xx1HC30;  
 2558 EQU1285..yy3HC30 =e= K3E633\*xx3HC30;  
 2559 EQU1286..yy4HC30 =e= K4E633\*xx4HC30;  
 2560 EQU1287..yy5HC30 =e= K5E633\*xx5HC30;  
 2561 EQU1288..yy7HC30 =e= K7E633\*xx7HC30;  
 2562 EQU1289..yy1R29 =e= K1E6XX\*xx1R29;

2563 EQU1290..yy3R29 =e= K3E6XX\*xx3R29;  
 2564 EQU1291..yy4R29 =e= K4E6XX\*xx4R29;  
 2565 EQU1292..yy5R29 =e= K5E6XX\*xx5R29;  
 2566 EQU1293..yy7R29 =e= K7E6XX\*xx7R29;  
 2567 EQU1294..TR1-TR29 =e= 0;  
 2568 EQU1295..(F1HC29\*x7HC29 + FvHC29\*y7HC29) - (F1HC30\*x7HC30 + FvHC30\*y7HC30) =e= 0;  
 2569 EQU1296..(hC623+hC625+hC627+hC629) - (hR29 - hR1) =e= 0;  
 2570 EQU1297..(F1R1\*x7R1 + FvR1\*y7R1) - (F1R29\*x7R29 + FvR29\*y7R29) =e= 0;  
 2571 EQU1298..(F1R1\*x5R1 + FvR1\*y5R1) - (F1R29\*x5R29 + FvR29\*y5R29) =e= 0;  
 2572 EQU1299..(F1R1\*x1R1 + FvR1\*y1R1) - (F1R29\*x1R29 + FvR29\*y1R29) =e= 0;  
 2573 EQU1300..(F1R1\*x3R1 + FvR1\*y3R1) - (F1R29\*x3R29 + FvR29\*y3R29) =e= 0;  
 2574 EQU1301..(F1R1\*x4R1 + FvR1\*y4R1) - (F1R29\*x4R29 + FvR29\*y4R29) =e= 0;  
 2575 EQU1302..(F1R1 + FvR1) - (F1R29 + FvR29) =e= 0;  
 2576 EQU1303..(hC623+hC625+hC627+hC629) - UE6XX\*AE6XX\*dTE6XX =e= 0;  
 2577 EQU1304..K1E6XX\*PR29 =e= 3.71\*PE633;  
 2578 EQU1305..FC418 \* x2C418 - FC417 \* x1C417 =e= 0;  
 \_Economic Optimization Program

05/15/01 16:49:39 PAGE 60  
GAMS 2.50A Windows NT/95/98

2579 EQU1306..FC302 =e= VFC614B\*FC311;  
 2580 EQU1307..FC311 - FC302 - FHC32 =e= 0;  
 2581 EQU1308..K1C614B\*PC302 =e= 0.1333\*10\*\*(21.4469-1.4627E3/TC302-5.261\*LOG10(TC302)+3.282E-11\*TC302+3.7349E-6\*TC302\*\*2);  
 2582 EQU1309..K3C614B\*PC302 =e= 0.1333\*10\*\*(31.2541-1.9532E3/TC302-8.806\*LOG10(TC302)+8.9246E-11\*TC302+5.7501E-6\*TC302\*\*2);  
 2583 EQU1310..FC311\*x1C311 - FC302\*x1C302 - FHC32\*x1HC32 =e= 0;  
 2584 EQU1311..FC311\*x3C311 - FC302\*x3C302 - FHC32\*x3HC32 =e= 0;  
 2585 EQU1312..FC311\*x4C311 - FC302\*x4C302 - FHC32\*x4HC32 =e= 0;  
 2586 EQU1313..FC311\*x7C311 - FC302\*x7C302 - FHC32\*x7HC32 =e= 0;  
 2587 EQU1314..hHC01 - FHC01 \* ((x1HC01/MW1)\*(SUM(Coeff,1/ORD(Coeff)\* Enth\_liq("1",Coeff)\*POWER(THC01,ORD(Coeff))))  
 2588 +(x2HC01/MW2)\*(SUM(Coeff,1/ORD(Coeff)\* Enth\_liq("2",Coeff)\* POWER(THC01,ORD(Coeff))))  
 2589 +(x3HC01/MW3)\*(SUM(Coeff,1/ORD(Coeff)\* Enth\_liq("3",Coeff)\* POWER(THC01,ORD(Coeff))))  
 2590 +(x4HC01/MW4)\*(SUM(Coeff,1/ORD(Coeff)\* Enth\_liq("4",Coeff)\* POWER(THC01,ORD(Coeff))))  
 2591 +(x5HC01/MW5)\*(SUM(Coeff,1/ORD(Coeff)\* Enth\_liq("5",Coeff)\* POWER(THC01,ORD(Coeff))))  
 2592 +(x7HC01/MW7)\*(SUM(Coeff,1/ORD(Coeff)\* Enth\_liq("7",Coeff)\* POWER(THC01,ORD(Coeff)))) =e= 0;  
 2593 EQU1315..x1HC01 + x2HC01 + x3HC01 + x4HC01 + x5HC01 + x7HC01 =e= 1;  
 2594 EQU1316..hC401 - FC401 \* ((x1C401/MW1)\*(SUM(Coeff,1/ORD(Coeff)\* Enth\_liq("1",Coeff)\*POWER(TC401,ORD(Coeff))))  
 2595 +(x3C401/MW3)\*(SUM(Coeff,1/ORD(Coeff)\* Enth\_liq("3",Coeff)\* POWER(TC401,ORD(Coeff))))  
 2596 +(x4C401/MW4)\*(SUM(Coeff,1/ORD(Coeff)\* Enth\_liq("4",Coeff)\* POWER(TC401,ORD(Coeff))))  
 2597 +(x5C401/MW5)\*(SUM(Coeff,1/ORD(Coeff)\* Enth\_liq("5",Coeff)\* POWER(TC401,ORD(Coeff))))  
 2598 +(x7C401/MW7)\*(SUM(Coeff,1/ORD(Coeff)\* Enth\_liq("7",Coeff)\* POWER(TC401,ORD(Coeff)))) =e= 0;  
 2599 EQU1317..x1C401 + x3C401 + x4C401 + x5C401 + x7C401 =e= 1;  
 2600 EQU1318..TAC09=e=TAC05;  
 2601 EQU1319..TAC09=e=TAC12;  
 2602 EQU1320..TAC09=e=THC27;  
 2603 EQU1321..hAC02 + hAC05 =e= hAC07;  
 2604 EQU1322..FHC27\*THC27 + FHC26\*THC26 =e= FHC28\*THC28;  
 2605 EQU1323..TAC20 - TAC15 =e= 0;  
 2606 EQU1324..TAC20 - TAC23 =e= 0;  
 2607 EQU1325..TAC20 - THC25 =e= 0;  
 2608 EQU1326..hAC12 + hAC15 - hAC18 =e= 0;  
 2609 EQU1327..FHC26\*THC26 - FHC25 \*THC25 - FHC24 \*THC24 =e= 0;  
 2610 EQU1328..hAC23 + hAC26 - hAC29 =e= 0;  
 2611 EQU1329..TAC31 - TAC26 =e= 0;  
 2612 EQU1330..TAC31 - TAC34 =e= 0;  
 2613 EQU1331..TAC31 - THC23 =e= 0;  
 2614 EQU1332..FHC24\*THC24 - FHC23 \*THC23 - FHC22 \*THC22 =e= 0;  
 2615 EQU1333..hAC34 + hAC37 - hAC40 =e= 0;  
 2616 EQU1334..TAC42 =e= TAC37;  
 2617 EQU1335..TAC42 =e= TAC45;  
 2618 EQU1336..TAC42 =e= THC22;  
 2619 EQU1337..hHC30 + hR29 =e= hHC31;  
 2620 EQU1338..(hC312 - hC312liq) - FcwE641A\*4.197\*(TcwotE641A - Tcwin) =e= 0;  
 2621 EQU1339..hC312liq - FC312\*  
 2622 ((x1C312/MW1)\*(SUM(Coeff,1/ORD(Coeff)\* Enth\_liq("1",Coeff)\*POWER(TC312,ORD(Coeff))))  
 2623 +(x3C312/MW3)\*(SUM(Coeff,1/ORD(Coeff)\* Enth\_liq("3",Coeff)\* POWER(TC312,ORD(Coeff))))  
 2624 +(x4C312/MW4)\*(SUM(Coeff,1/ORD(Coeff)\* Enth\_liq("4",Coeff)\* POWER(TC312,ORD(Coeff))))  
 \_Economic Optimization Program

05/15/01 16:49:39 PAGE 61  
GAMS 2.50A Windows NT/95/98

2625 +(x5C312/MW5)\*(SUM(Coeff,1/ORD(Coeff)\* Enth\_liq("5",Coeff)\*POWER(TC312,ORD(Coeff))))  
 2626 +(x7C312/MW7)\*(SUM(Coeff,1/ORD(Coeff)\* Enth\_liq("7",Coeff)\*POWER(TC312,ORD(Coeff)))) =e= 0;  
 2627 EQU1340..THC31 =e= TC401;  
 2628 EQU1341..THC31 - TC301 =e= 0;  
 2629 EQU1342..xx4C407 \* FmC407 \* MW4 - FC407 \* x4C407 =e= 0;  
 2630 EQU1343..FmC407 - FC407 \* (x1C407/MW1 + x3C407/MW3 + x4C407/MW4 + x5C407/MW5 + x7C407/MW7 ) =e= 0;  
 2631 EQU1344..xx5C407 \* FmC407 \* MW5 - FC407 \* x5C407 =e= 0;  
 2632 EQU1345..xx3C407 \* FmC407 \* MW3 - FC407 \* x3C407 =e= 0;  
 2633 EQU1346..FmC412 - FC412 \* (x1C412/MW1 + x3C412/MW3 + x4C412/MW4 + x5C412/MW5 + x7C412/MW7 ) =e= 0;  
 2634 EQU1347..xx4C412 \* FmC412 \* MW4 - FC412 \* x4C412 =e= 0;  
 2635 EQU1348..xx3C412 \* FmC412 \* MW3 - FC412 \* x3C412 =e= 0;  
 2636 EQU1349..xx5C412 \* FmC412 \* MW5 - FC412 \* x5C412 =e= 0;  
 2637 EQU1350..xx4C322 \* FmC322 \* MW4 - FC322 \* x4C322 =e= 0;  
 2638 EQU1351..xx1C322 \* FmC322 \* MW1 - FC322 \* x1C322 =e= 0;  
 2639 EQU1352..FmC317 - FC317 \* (x1C317/MW1 + x3C317/MW3 + x4C317/MW4 + x5C317/MW5 + x7C317/MW7 ) =e= 0;  
 2640 EQU1353..xx4C317 \* FmC317 \* MW4 - FC317 \* x4C317 =e= 0;  
 2641 EQU1354..xx3C317 \* FmC317 \* MW3 - FC317 \* x3C317 =e= 0;  
 2642 EQU1355..FmHC01 - FHC01 \* (x1HC01/MW1 + x2HC01/MW2 + x3HC01/MW3 + x4HC01/MW4 + x5HC01/MW5 + x7HC01/MW7) =e= 0;  
 2643 EQU1356..xx1HC01 \* MW1 \* FmHC01 - FHC01 \* x1HC01 =e= 0;  
 2644 EQU1357..xx2HC01 \* MW2 \* FmHC01 - FHC01 \* x2HC01 =e= 0;  
 2645 EQU1358..xx3HC01 \* MW3 \* FmHC01 - FHC01 \* x3HC01 =e= 0;  
 2646 EQU1359..xx4HC01 \* MW4 \* FmHC01 - FHC01 \* x4HC01 =e= 0;

2647 EQU1360..x2C418 - x2C419 =e= 0;  
 2648 EQU1361..FHC03 \* x2HC03 - FC419 \* x2C419 =e= 0;  
 2649 EQU1362..FC417 - FSC414 - FSC413 =e= 0;  
 2650 EQU1363..FC417 \* x1C417- FSC414\* x1SC414 - FSC413\* x1SC413 =e= 0;  
 2651 EQU1364..hC417 - hSC414 - hSC413 =e= 0;  
 2652 EQU1365..FC417 \* x2C417- FSC414\* x2SC414 - FSC413\* x2SC413 =e= 0;  
 2653 EQU1366..FC417 \* x3C417- FSC414\* x3SC414 - FSC413\* x3SC413 =e= 0;  
 2654 EQU1367..FC417 \* x4C417- FSC414\* x4SC414 - FSC413\* x4SC413 =e= 0;  
 2655 EQU1368..FC417 \* x5C417- FSC414\* x5SC414 - FSC413\* x5SC413 =e= 0;  
 2656 EQU1369..(hSC404 - hSC405) - UE603\*AE603\*FE603\*dTE603 =e= 0;  
 2657 EQU1370..x3SC409 - x3SC412 =e= 0;  
 2658 EQU1371..x6SC409 - x6SC412 =e= 0;  
 2659 EQU1372..x6SC409 - x6SC411 =e= 0;  
 2660 EQU1373..x2SC409 - x2SC411 =e= 0;  
 2661 EQU1374..x1SC409 - x1SC411 =e= 0;  
 2662 EQU1375..x3SC409 - x3SC411 =e= 0;  
 2663 EQU1376..x4SC409 - x4SC411 =e= 0;  
 2664 EQU1377..x2SC409 - x2SC412 =e= 0;  
 2665 EQU1378..x7SC409 - x7SC411 =e= 0;  
 2666 EQU1379..x1SC409 - x1SC412 =e= 0;  
 2667 EQU1380..x4SC409 - x4SC412 =e= 0;  
 2668 EQU1381..x5SC409 - x5SC412 =e= 0;  
 2669 EQU1382..FSC409 - FSC411 - FSC412 =e= 0;  
 2670 EQU1383..TSC409 - TSC412 =e= 0;  
 \_Economic Optimization Program

2671 EQU1384..TSC409 - TSC411 =e= 0;  
 2672 EQU1385..x7SC409 - x7SC412 =e= 0;  
 2673 EQU1386..x5SC409 - x5SC411 =e= 0;  
 2674 EQU1387..RC601\*FSC412 - FSC411 =e= 0;  
 2675 EQU1388..x3SC412 - x3SC413 =e= 0;  
 2676 EQU1389..dTE609A\*\*3 =e= ((TSC412-TcwotE609A)\*(TSC413-Tcwin)\*  
 2677 ((TSC412-TcwotE609A)+(TSC413-Tcwin))/2);  
 2678 EQU1390..x4SC412 - x4SC413 =e= 0;  
 2679 EQU1391..x1SC412 - x1SC413 =e= 0;  
 2680 EQU1392..x2SC412 - x2SC413 =e= 0;  
 2681 EQU1393..x6SC412 - x6SC413 =e= 0;  
 2682 EQU1394..FSC412 - FSC413 =e= 0;  
 2683 EQU1395..(hSC412 - hSC413) - UE609A\*AE609A\*FE609A\*dTE609A =e= 0;  
 2684 EQU1396..(hSC412 - hSC413) - FcwE609A\*4.197\*(TcwotE609A - Tcwin) =e= 0;  
 2685 EQU1397..x5SC412 - x5SC413 =e= 0;  
 2686 EQU1398..(hSC408 - hSC409) - FcwE605\*4.197\*(TcwoutE605 - Tcwin) =e= 0;  
 2687 EQU1399..x3SC408 - x3SC409 =e= 0;  
 2688 EQU1400..x7SC408 - x7SC409 =e= 0;  
 2689 EQU1401..FSC408 - FSC409 =e= 0;  
 2690 EQU1402..TSC408 - TSC409 =e= 0;  
 2691 EQU1403..(hSC408 - hSC409) - UE605\*AE605\*dTE605 =e= 0;  
 2692 EQU1404..dTE605\*2 =e=  
 2693 (TSC408-TcwoutE605) + (TSC409-Tcwin);  
 2694 EQU1405..x1SC408 - x1SC409 =e= 0;  
 2695 EQU1406..x5SC408 - x5SC409 =e= 0;  
 2696 EQU1407..x4SC408 - x4SC409 =e= 0;  
 2697 EQU1408..x2SC408 - x2SC409 =e= 0;  
 2698 EQU1409..x6SC408 - x6SC409 =e= 0;  
 2699 EQU1410..x5SC404 - x5SC405 =e= 0;  
 2700 EQU1411..x6SC404 - x6SC405 =e= 0;  
 2701 EQU1412..(hSC404 - hSC405) - FcwE603\*4.197\*(TcwoutE603 - Tcwin) =e= 0;  
 2702 EQU1413..x4SC404 - x4SC405 =e= 0;  
 2703 EQU1414..x3SC404 - x3SC405 =e= 0;  
 2704 EQU1415..x1SC404 - x1SC405 =e= 0;  
 2705 EQU1416..dTE603\*\*3 =e= ((TSC404-TcwoutE603)\*(TSC405-Tcwin)\*  
 2706 ((TSC404-TcwoutE603)+(TSC405-Tcwin))/2);  
 2707 EQU1417..FSC404 - FSC405 =e= 0;  
 2708 EQU1418..x2SC404 - x2SC405 =e= 0;  
 2709 EQU1419..TSC407 - TSC406 =e= 0;  
 2710 EQU1420..x3SC407 - x3SC406 =e= 0;  
 2711 EQU1421..x4SC407 - x4SC406 =e= 0;  
 2712 EQU1422..dTE602 =e= 414.6 - TSC406;  
 2713 EQU1423..x6SC407 - x6SC406 =e= 0;  
 2714 EQU1424..x1SC407 - x1SC406 =e= 0;  
 2715 EQU1425..(hSC407 - hSC406) - UE602\*AE602\*dTE602 =e= 0;  
 2716 EQU1426..(hSC407 - hSC406) - FstmE602 \* hstmE602 =e= 0;  
 \_Economic Optimization Program

2717 EQU1427..x2SC407 - x2SC406 =e= 0;  
 2718 EQU1428..FSC407 - FSC406 =e= 0;  
 2719 EQU1429..x5SC407 - x5SC406 =e= 0;  
 2720 EQU1430..x3SC401 - x3SC402 =e= 0;  
 2721 EQU1431..x4SC401 - x4SC402 =e= 0;  
 2722 EQU1432..x5SC403 - x5SC404 =e= 0;  
 2723 EQU1433..x3SC403 - x3SC404 =e= 0;  
 2724 EQU1434..x2SC403 - x2SC406 =e= 0;  
 2725 EQU1435..Sm4C601\*LpC601=e= Kp4C601\*VpC601;  
 2726 EQU1436..f4C601 \* x4SC402 \* FSC402 =e= x4SC403 \* FSC403;  
 2727 EQU1437..x1SC403 - x1SC406 =e= 0;  
 2728 EQU1438..K3C601\*PC601 =e= 0.1333\*10\*\*(31.2541-1.9532E3/TnC601-8.806\*LOG10(TnC601)+8.9246E-11\*TnC601+5.7501E-6\*TnC601\*\*2);  
 2729 EQU1439..K6C601\*PC601 =e= 0.1333\*10\*\*(33.3239-2.4227E3/TnC601-9.2354\*LOG10(TnC601)+9.0199E-11\*TnC601+4.1050E-6\*TnC601\*\*2);  
 2730 EQU1440..K1C601\*PC601 =e= 0.1333\*10\*\*(21.4469-1.4627E3/TnC601-5.261\*LOG10(TnC601)+3.282E-11\*TnC601+3.7349E-6\*TnC601\*\*2);

2731 EQU1441..K2C601\*PC601 =e= 0.1333\*10\*\*(33.9868-2.0916E3/TnC601-10.048\*LOG10(TnC601)+3.0198E-3\*TnC601+2.9122E-6\*TnC601\*\*2);

2732 EQU1442..x5SC403 - x5SC406 =e= 0;

2733 EQU1443..Kp3C601\*PC601 =e= 0.1333\*10\*\*(31.2541-1.9532E3/TmC601-8.806\*LOG10(TmC601)+8.9246E-11\*TmC601+5.7501E-6\*TmC601\*\*2);

2734 EQU1444..x3SC403 - x3SC406 =e= 0;

2735 EQU1445..Kp1C601\*PC601 =e= 0.1333\*10\*\*(21.4469-1.4627E3/TmC601-5.261\*LOG10(TmC601)+3.282E-11\*TmC601+3.7349E-6\*TmC601\*\*2);

2736 EQU1446..FSC402 \* x5SC402 + FSC411\*x5SC411 - FSC403 \* x5SC403 - FSC408\*x5SC408 =e= 0;

2737 EQU1447..Sn7C601 \*FSC411 =e= K7C601\*FSC408;

2738 EQU1448..FSC402 \* x4SC402 + FSC411\*x4SC411 - FSC403 \* x4SC403 - FSC408\*x4SC408 =e= 0;

2739 EQU1449..FSC402 \* x3SC402 + FSC411\*x3SC411 - FSC403 \* x3SC403 - FSC408\*x3SC408 =e= 0;

2740 EQU1450..FSC402 \* x1SC402 + FSC411\*x1SC411 - FSC403 \* x1SC403 - FSC408\*x1SC408 =e= 0;

2741 EQU1451..FSC402 + FSC411 - FSC403 - FSC408 =e= 0;

2742 EQU1452..x4SC403 - x4SC406 =e= 0;

2743 EQU1453..TSC403 - TSC406 =e= 0;

2744 EQU1454..Kp4C601\*PC601 =e= 0.1333\*10\*\*(27.0441-1.9049E3/TmC601-7.1805\*LOG10(TmC601)-6.6845E-11\*TmC601+4.219E-6\*TmC601\*\*2);

2745 EQU1455..K5C601\*PC601 =e= 0.1333\*10\*\*(29.2963-2.1762E3/TnC601-7.883\*LOG10(TnC601)-4.6512E-11\*TnC601+3.8997E-6\*TnC601\*\*2);

2746 EQU1456..Kp5C601\*PC601 =e= 0.1333\*10\*\*(29.2963-2.1762E3/TmC601-7.883\*LOG10(TmC601)-4.6512E-11\*TmC601+3.8997E-6\*TmC601\*\*2);

2747 EQU1457..K7C601\*PC601 =e= 0.1333\*10\*\*(33.0162-2.583E3/TnC601-9.042\*LOG10(TnC601)-1.371E-12\*TnC601+3.634E-6\*TnC601\*\*2);

2748 EQU1458..Kp2C601\*PC601 =e= 0.1333\*10\*\*(33.9868-2.0916E3/TmC601-10.048\*LOG10(TmC601)+3.0198E-3\*TmC601+2.9122E-6\*TmC601\*\*2);

2749 EQU1459..x6SC403 - x6SC406 =e= 0;

2750 EQU1460..x7SC403 - x7SC406 =e= 0;

2751 EQU1461..LpC601=e=FSC411 + qC601\*FSC402;

2752 EQU1462..Sn1C601 \*FSC411 =e= K1C601\*FSC408;

2753 EQU1463..K4C601\*PC601 =e= 0.1333\*10\*\*(27.0441-1.9049E3/TnC601-7.1805\*LOG10(TnC601)-6.6845E-11\*TnC601+4.219E-6\*TnC601\*\*2);

2754 EQU1464..Kp7C601\*PC601 =e= 0.1333\*10\*\*(33.0162-2.583E3/TmC601-9.042\*LOG10(TmC601)-1.371E-12\*TmC601+3.634E-6\*TmC601\*\*2);

2755 EQU1465..TmC601=e=(TSC403+TSC402)/2;

2756 EQU1466..TnC601=e=(TSC408+TSC402)/2;

2757 EQU1467..VpC601=e=LpC601 - FSC403;

2758 EQU1468..x1SC413 + x2SC413 + x3SC413 + x4SC413 + x5SC413 + x6SC413 + x7SC413=e= 1;

2759 EQU1469..hSC413 - FSC413 \* ((x1SC413/MW1)\*(SUM(Coeff,1/ORD(Coeff) \* Enth\_liq("1",Coeff) \*POWER(TSC413,ORD(Coeff))))

2760 +(x2SC413/MW2)\*(SUM(Coeff,1/ORD(Coeff) \* Enth\_liq("2",Coeff) \*POWER(TSC413,ORD(Coeff))))

2761 +(x3SC413/MW3)\*(SUM(Coeff,1/ORD(Coeff) \* Enth\_liq("3",Coeff) \* POWER(TSC413,ORD(Coeff))))

2762 +(x4SC413/MW4)\*(SUM(Coeff,1/ORD(Coeff) \* Enth\_liq("4",Coeff) \*POWER(TSC413,ORD(Coeff))))

\_Economic Optimization Program

2763 +(x5SC413/MW5)\*(SUM(Coeff,1/ORD(Coeff) \* Enth\_liq("5",Coeff) \*POWER(TSC413,ORD(Coeff))))

2764 +(x6SC413/MW6)\*(SUM(Coeff,1/ORD(Coeff) \* Enth\_liq("6",Coeff) \*POWER(TSC413,ORD(Coeff))))

2765 +(x7SC413/MW7)\*(SUM(Coeff,1/ORD(Coeff) \* Enth\_liq("7",Coeff) \*POWER(TSC413,ORD(Coeff)))) =e= 0;

2766 EQU1470..hSC414 - FSC414 \* ((x1SC414/MW1)\*(SUM(Coeff,1/ORD(Coeff) \* Enth\_liq("1",Coeff) \*POWER(TSC414,ORD(Coeff))))

2767 +(x2SC414/MW2)\*(SUM(Coeff,1/ORD(Coeff) \* Enth\_liq("2",Coeff) \*POWER(TSC414,ORD(Coeff))))

2768 +(x3SC414/MW3)\*(SUM(Coeff,1/ORD(Coeff) \* Enth\_liq("3",Coeff) \* POWER(TSC414,ORD(Coeff))))

2769 +(x4SC414/MW4)\*(SUM(Coeff,1/ORD(Coeff) \* Enth\_liq("4",Coeff) \*POWER(TSC414,ORD(Coeff))))

2770 +(x5SC414/MW5)\*(SUM(Coeff,1/ORD(Coeff) \* Enth\_liq("5",Coeff) \*POWER(TSC414,ORD(Coeff))))

2771 +(x6SC414/MW6)\*(SUM(Coeff,1/ORD(Coeff) \* Enth\_liq("6",Coeff) \*POWER(TSC414,ORD(Coeff))))

2772 +(x7SC414/MW7)\*(SUM(Coeff,1/ORD(Coeff) \* Enth\_liq("7",Coeff) \*POWER(TSC414,ORD(Coeff)))) =e= 0;

2773 EQU1471..x1SC414 + x2SC414 + x3SC414 + x4SC414 + x5SC414 + x6SC414 + x7SC414=e= 1;

2774 EQU1472..hSC412 - FSC412 \* ((x1SC412/MW1)\*(SUM(Coeff,1/ORD(Coeff) \* Enth\_liq("1",Coeff) \*POWER(TSC412,ORD(Coeff))))

2775 +(x2SC412/MW2)\*(SUM(Coeff,1/ORD(Coeff) \* Enth\_liq("2",Coeff) \*POWER(TSC412,ORD(Coeff))))

2776 +(x3SC412/MW3)\*(SUM(Coeff,1/ORD(Coeff) \* Enth\_liq("3",Coeff) \* POWER(TSC412,ORD(Coeff))))

2777 +(x4SC412/MW4)\*(SUM(Coeff,1/ORD(Coeff) \* Enth\_liq("4",Coeff) \*POWER(TSC412,ORD(Coeff))))

2778 +(x5SC412/MW5)\*(SUM(Coeff,1/ORD(Coeff) \* Enth\_liq("5",Coeff) \*POWER(TSC412,ORD(Coeff))))

2779 +(x6SC412/MW6)\*(SUM(Coeff,1/ORD(Coeff) \* Enth\_liq("6",Coeff) \*POWER(TSC412,ORD(Coeff))))

2780 +(x7SC412/MW7)\*(SUM(Coeff,1/ORD(Coeff) \* Enth\_liq("7",Coeff) \*POWER(TSC412,ORD(Coeff)))) =e= 0;

2781 EQU1473..x1SC412 + x2SC412 + x3SC412 + x4SC412 + x5SC412 + x6SC412 + x7SC412 =e= 1;

2782 EQU1474..hSC411 - FSC411 \* ((x1SC411/MW1)\*(SUM(Coeff,1/ORD(Coeff) \* Enth\_liq("1",Coeff) \*POWER(TSC411,ORD(Coeff))))

2783 +(x2SC411/MW2)\*(SUM(Coeff,1/ORD(Coeff) \* Enth\_liq("2",Coeff) \*POWER(TSC411,ORD(Coeff))))

2784 +(x3SC411/MW3)\*(SUM(Coeff,1/ORD(Coeff) \* Enth\_liq("3",Coeff) \* POWER(TSC411,ORD(Coeff))))

2785 +(x4SC411/MW4)\*(SUM(Coeff,1/ORD(Coeff) \* Enth\_liq("4",Coeff) \*POWER(TSC411,ORD(Coeff))))

2786 +(x5SC411/MW5)\*(SUM(Coeff,1/ORD(Coeff) \* Enth\_liq("5",Coeff) \*POWER(TSC411,ORD(Coeff))))

2787 +(x6SC411/MW6)\*(SUM(Coeff,1/ORD(Coeff) \* Enth\_liq("6",Coeff) \*POWER(TSC411,ORD(Coeff))))

2788 +(x7SC411/MW7)\*(SUM(Coeff,1/ORD(Coeff) \* Enth\_liq("7",Coeff) \*POWER(TSC411,ORD(Coeff)))) =e= 0;

2789 EQU1475..hSC409 - FSC409 \* ((x1SC409/MW1)\*(SUM(Coeff,1/ORD(Coeff) \* Enth\_liq("1",Coeff) \*POWER(TSC409,ORD(Coeff))))

2790 +(x2SC409/MW2)\*(SUM(Coeff,1/ORD(Coeff) \* Enth\_liq("2",Coeff) \*POWER(TSC409,ORD(Coeff))))

2791 +(x3SC409/MW3)\*(SUM(Coeff,1/ORD(Coeff) \* Enth\_liq("3",Coeff) \* POWER(TSC409,ORD(Coeff))))

2792 +(x4SC409/MW4)\*(SUM(Coeff,1/ORD(Coeff) \* Enth\_liq("4",Coeff) \*POWER(TSC409,ORD(Coeff))))

2793 +(x5SC409/MW5)\*(SUM(Coeff,1/ORD(Coeff) \* Enth\_liq("5",Coeff) \*POWER(TSC409,ORD(Coeff))))

2794 +(x6SC409/MW6)\*(SUM(Coeff,1/ORD(Coeff) \* Enth\_liq("6",Coeff) \*POWER(TSC409,ORD(Coeff))))

2795 +(x7SC409/MW7)\*(SUM(Coeff,1/ORD(Coeff) \* Enth\_liq("7",Coeff) \*POWER(TSC409,ORD(Coeff)))) =e= 0;

2796 EQU1476..x1SC409 + x2SC409 + x3SC409 + x4SC409 + x5SC409 + x6SC409 + x7SC409 =e= 1;

2797 EQU1477..xx1SC408 \* MW1 \* FmSC408 - FSC408 \* x1SC408 =e= 0;

2798 EQU1478..K6SC408\*PC601 =e= 0.1333\*10\*\*(33.3239-2.4227E3/TSC408-9.2354\*LOG10(TSC408)+9.0199E-11\*TSC408+4.1050E-6\*TSC408\*\*2);

2799 EQU1479..xx6SC408 \* MW6 \* FmSC408 - FSC408 \* x6SC408 =e= 0;

2800 EQU1480..xx2SC408 \* MW2 \* FmSC408 - FSC408 \* x2SC408 =e= 0;

2801 EQU1481..xx1SC408+xx2SC408+xx3SC408+xx4SC408+xx5SC408+xx6SC408+xx7SC408 =e= 1;

2802 EQU1482..xx5SC408 \* MW5 \* FmSC408 - FSC408 \* x5SC408 =e= 0;

2803 EQU1483..K2SC408\*PC601 =e= 0.1333\*10\*\*(33.9868-2.0916E3/TSC408-10.048\*LOG10(TSC408)+3.0198E-3\*TSC408+2.9122E-6\*TSC408\*\*2);

2804 EQU1484..xx3SC408 \* MW3 \* FmSC408 - FSC408 \* x3SC408 =e= 0;

2805 EQU1485..K3SC408\*PC601 =e= 0.1333\*10\*\*(31.2541-1.9532E3/TSC408-8.806\*LOG10(TSC408)+8.9246E-11\*TSC408+5.7501E-6\*TSC408\*\*2);

2806 EQU1486..FmSC408 - FSC408 \* (x1SC408/MW1 + x2SC408/MW2 + x3SC408/MW3 + x4SC408/MW4 + x5SC408/MW5 + x6SC408/MW6 + x7SC408/MW7)

=e= 0;

2807 EQU1487..xx1SC408/K1SC408+xx2SC408/K2SC408+xx3SC408/K3SC408+xx4SC408/K4SC408+xx5SC408/K5SC408+xx6SC408/K6SC408+xx7SC408/K7SC408

\_Economic Optimization Program

8 =e= 1;

2808 EQU1488..K7SC408\*PC601 =e= 0.1333\*10\*\*(33.0162-2.583E3/TSC408-9.042\*LOG10(TSC408)-1.371E-12\*TSC408+3.634E-6\*TSC408\*\*2);

2809 EQU1489..K5SC408\*PC601 =e= 0.1333\*10\*\*(29.2963-2.1762E3/TSC408-7.883\*LOG10(TSC408)-4.6512E-11\*TSC408+3.8997E-6\*TSC408\*\*2);

2810 EQU1490..K4SC408\*PC601 =e= 0.1333\*10\*\*(27.0441-1.9049E3/TSC408-7.1805\*LOG10(TSC408)-6.6845E-11\*TSC408+4.219E-6\*TSC408\*\*2);

2811 EQU1491..K1SC408\*PC601 =e= 0.1333\*10\*\*(21.4469-1.4627E3/TSC408-5.261\*LOG10(TSC408)+3.282E-11\*TSC408+3.7349E-6\*TSC408\*\*2);

2812 EQU1492..x1SC408 + x2SC408 + x3SC408 + x4SC408 + x5SC408 + x6SC408 + x7SC408 =e= 1;



2813 EQU1493..xx4SC408 \* MW4 \* FmSC408 - FSC408 \* x4SC408=e= 0;  
 2814 EQU1494..x1SC407 + x2SC407 + x3SC407 + x4SC407 + x5SC407 + x6SC407 + x7SC407 =e= 1;  
 2815 EQU1495..xx1SC406+xx2SC406+xx3SC406+xx4SC406+xx5SC406+xx6SC406+xx7SC406 =e= 1;  
 2816 EQU1496..K7SC406\*PC601 =e= 0.1333\*10\*\*(33.0162-2.583E3/TSC406-9.042\*LOG10(TSC406))-1.371E-12\*TSC406+3.634E-6\*TSC406\*\*2);  
 2817  
 EQU1497..K1SC406\*xx1SC406+K2SC406\*xx2SC406+K3SC406\*xx3SC406+K4SC406\*xx4SC406+K5SC406\*xx5SC406+K6SC406\*xx6SC406+K7SC406\*xx7SC406  
 6 =e= 1;  
 2818 EQU1498..FmSC406 - FSC406 \* (x1SC406/MW1 + x2SC406/MW2 + x3SC406/MW3 + x4SC406/MW4 + x5SC406/MW5 + x6SC406/MW6 + x7SC406/MW7)  
 =e= 0;  
 2819 EQU1499..xx2SC406 \* MW2 \* FmSC406 - FSC406 \* x2SC406=e= 0;  
 2820 EQU1500..xx6SC406 \* MW6 \* FmSC406 - FSC406 \* x6SC406=e= 0;  
 2821 EQU1501..K2SC406\*PC601 =e= 0.1333\*10\*\*(33.9868-2.0916E3/TSC406-10.048\*LOG10(TSC406)+3.0198E-3\*TSC406+2.9122E-6\*TSC406\*\*2);  
 2822 EQU1502..K6SC406\*PC601 =e= 0.1333\*10\*\*(33.3239-2.4227E3/TSC406-9.2354\*LOG10(TSC406)+9.0199E-11\*TSC406+4.1050E-6\*TSC406\*\*2);  
 2823 EQU1503..xx1SC406 \* MW1 \* FmSC406 - FSC406 \* x1SC406=e= 0;  
 2824 EQU1504..xx3SC406 \* MW3 \* FmSC406 - FSC406 \* x3SC406=e= 0;  
 2825 EQU1505..xx4SC406 \* MW4 \* FmSC406 - FSC406 \* x4SC406=e= 0;  
 2826 EQU1506..K5SC406\*PC601 =e= 0.1333\*10\*\*(29.2963-2.1762E3/TSC406-7.883\*LOG10(TSC406)-4.6512E-11\*TSC406+3.8997E-6\*TSC406\*\*2);  
 2827 EQU1507..xx5SC406 \* MW5 \* FmSC406 - FSC406 \* x5SC406=e= 0;  
 2828 EQU1508..x1SC406 + x2SC406 + x3SC406 + x4SC406 + x5SC406 + x6SC406 + x7SC406 =e= 1;  
 2829 EQU1509..K4SC406\*PC601 =e= 0.1333\*10\*\*(27.0441-1.9049E3/TSC406-7.1805\*LOG10(TSC406)-6.6845E-11\*TSC406+4.219E-6\*TSC406\*\*2);  
 2830 EQU1510..K3SC406\*PC601 =e= 0.1333\*10\*\*(31.2541-1.9532E3/TSC406-8.806\*LOG10(TSC406)+8.9246E-11\*TSC406+5.7501E-6\*TSC406\*\*2);  
 2831 EQU1511..K1SC406\*PC601 =e= 0.1333\*10\*\*(21.4469-1.4627E3/TSC406-5.261\*LOG10(TSC406)+3.282E-11\*TSC406+3.7349E-6\*TSC406\*\*2);  
 2832 EQU1512..hSC406 - FSC406 \* ((x1SC406/MW1)\*(SUM(Coeff,1/ORD(Coeff)) \* Enth\_liq("1",Coeff) \*POWER(TSC406,ORD(Coeff))))  
 2833 +(x2SC406/MW2)\*(SUM(Coeff,1/ORD(Coeff)) \* Enth\_liq("2",Coeff) \*POWER(TSC406,ORD(Coeff))))  
 2834 +(x3SC406/MW3)\*(SUM(Coeff,1/ORD(Coeff)) \* Enth\_liq("3",Coeff) \* POWER(TSC406,ORD(Coeff))))  
 2835 +(x4SC406/MW4)\*(SUM(Coeff,1/ORD(Coeff)) \* Enth\_liq("4",Coeff) \*POWER(TSC406,ORD(Coeff))))  
 2836 +(x5SC406/MW5)\*(SUM(Coeff,1/ORD(Coeff)) \* Enth\_liq("5",Coeff) \*POWER(TSC406,ORD(Coeff))))  
 2837 +(x6SC406/MW6)\*(SUM(Coeff,1/ORD(Coeff)) \* Enth\_liq("6",Coeff) \*POWER(TSC406,ORD(Coeff))))  
 2838 +(x7SC406/MW7)\*(SUM(Coeff,1/ORD(Coeff)) \* Enth\_liq("7",Coeff) \*POWER(TSC406,ORD(Coeff)))) =e= 0;  
 2839 EQU1513..x1SC405 + x2SC405 + x3SC405 + x4SC405 + x5SC405 + x6SC405 + x7SC405 =e= 1;  
 2840 EQU1514..hSC405 - FSC405 \* ((x1SC405/MW1)\*(SUM(Coeff,1/ORD(Coeff)) \* Enth\_liq("1",Coeff) \*POWER(TSC405,ORD(Coeff))))  
 2841 +(x2SC405/MW2)\*(SUM(Coeff,1/ORD(Coeff)) \* Enth\_liq("2",Coeff) \*POWER(TSC405,ORD(Coeff))))  
 2842 +(x3SC405/MW3)\*(SUM(Coeff,1/ORD(Coeff)) \* Enth\_liq("3",Coeff) \* POWER(TSC405,ORD(Coeff))))  
 2843 +(x4SC405/MW4)\*(SUM(Coeff,1/ORD(Coeff)) \* Enth\_liq("4",Coeff) \*POWER(TSC405,ORD(Coeff))))  
 2844 +(x5SC405/MW5)\*(SUM(Coeff,1/ORD(Coeff)) \* Enth\_liq("5",Coeff) \*POWER(TSC405,ORD(Coeff))))  
 2845 +(x6SC405/MW6)\*(SUM(Coeff,1/ORD(Coeff)) \* Enth\_liq("6",Coeff) \*POWER(TSC405,ORD(Coeff))))  
 2846 +(x7SC405/MW7)\*(SUM(Coeff,1/ORD(Coeff)) \* Enth\_liq("7",Coeff) \*POWER(TSC405,ORD(Coeff)))) =e= 0;  
 2847 EQU1515..x1SC404 + x2SC404 + x3SC404 + x4SC404 + x5SC404 + x6SC404 + x7SC404 =e= 1;  
 2848 EQU1516..hSC404 - FSC404 \* ((x1SC404/MW1)\*(SUM(Coeff,1/ORD(Coeff)) \* Enth\_liq("1",Coeff) \*POWER(TSC404,ORD(Coeff))))  
 2849 +(x2SC404/MW2)\*(SUM(Coeff,1/ORD(Coeff)) \* Enth\_liq("2",Coeff) \*POWER(TSC404,ORD(Coeff))))  
 2850 +(x3SC404/MW3)\*(SUM(Coeff,1/ORD(Coeff)) \* Enth\_liq("3",Coeff) \* POWER(TSC404,ORD(Coeff))))  
 \_Economic Optimization Program 05/15/01 16:49:39 PAGE 66  
 GAMS 2.50A Windows NT/95/98

2851 +(x4SC404/MW4)\*(SUM(Coeff,1/ORD(Coeff)) \* Enth\_liq("4",Coeff) \*POWER(TSC404,ORD(Coeff))))  
 2852 +(x5SC404/MW5)\*(SUM(Coeff,1/ORD(Coeff)) \* Enth\_liq("5",Coeff) \*POWER(TSC404,ORD(Coeff))))  
 2853 +(x6SC404/MW6)\*(SUM(Coeff,1/ORD(Coeff)) \* Enth\_liq("6",Coeff) \*POWER(TSC404,ORD(Coeff))))  
 2854 +(x7SC404/MW7)\*(SUM(Coeff,1/ORD(Coeff)) \* Enth\_liq("7",Coeff) \*POWER(TSC404,ORD(Coeff)))) =e= 0;  
 2855 EQU1517..x1SC403 + x2SC403 + x3SC403 + x4SC403 + x5SC403 + x6SC403 + x7SC403 =e= 1;  
 2856 EQU1518..FmSC403 - FSC403 \* (x1SC403/MW1 + x2SC403/MW2 + x3SC403/MW3 + x4SC403/MW4 + x5SC403/MW5 + x6SC403/MW6 + x7SC403/MW7)  
 =e= 0;  
 2857 EQU1519..hSC403 - FSC403 \* ((x1SC403/MW1)\*(SUM(Coeff,1/ORD(Coeff)) \* Enth\_liq("1",Coeff) \*POWER(TSC403,ORD(Coeff))))  
 2858 +(x2SC403/MW2)\*(SUM(Coeff,1/ORD(Coeff)) \* Enth\_liq("2",Coeff) \*POWER(TSC403,ORD(Coeff))))  
 2859 +(x3SC403/MW3)\*(SUM(Coeff,1/ORD(Coeff)) \* Enth\_liq("3",Coeff) \* POWER(TSC403,ORD(Coeff))))  
 2860 +(x4SC403/MW4)\*(SUM(Coeff,1/ORD(Coeff)) \* Enth\_liq("4",Coeff) \*POWER(TSC403,ORD(Coeff))))  
 2861 +(x5SC403/MW5)\*(SUM(Coeff,1/ORD(Coeff)) \* Enth\_liq("5",Coeff) \*POWER(TSC403,ORD(Coeff))))  
 2862 +(x6SC403/MW6)\*(SUM(Coeff,1/ORD(Coeff)) \* Enth\_liq("6",Coeff) \*POWER(TSC403,ORD(Coeff))))  
 2863 +(x7SC403/MW7)\*(SUM(Coeff,1/ORD(Coeff)) \* Enth\_liq("7",Coeff) \*POWER(TSC403,ORD(Coeff)))) =e= 0;  
 2864 EQU1520..x1SC402 + x2SC402 + x3SC402 + x4SC402 + x5SC402 + x6SC402 + x7SC402 =e= 1;  
 2865 EQU1521..hSC402 - FSC402 \* ((x1SC402/MW1)\*(SUM(Coeff,1/ORD(Coeff)) \* Enth\_liq("1",Coeff) \*POWER(TSC402,ORD(Coeff))))  
 2866 +(x2SC402/MW2)\*(SUM(Coeff,1/ORD(Coeff)) \* Enth\_liq("2",Coeff) \*POWER(TSC402,ORD(Coeff))))  
 2867 +(x3SC402/MW3)\*(SUM(Coeff,1/ORD(Coeff)) \* Enth\_liq("3",Coeff) \* POWER(TSC402,ORD(Coeff))))  
 2868 +(x4SC402/MW4)\*(SUM(Coeff,1/ORD(Coeff)) \* Enth\_liq("4",Coeff) \*POWER(TSC402,ORD(Coeff))))  
 2869 +(x5SC402/MW5)\*(SUM(Coeff,1/ORD(Coeff)) \* Enth\_liq("5",Coeff) \*POWER(TSC402,ORD(Coeff))))  
 2870 +(x6SC402/MW6)\*(SUM(Coeff,1/ORD(Coeff)) \* Enth\_liq("6",Coeff) \*POWER(TSC402,ORD(Coeff))))  
 2871 +(x7SC402/MW7)\*(SUM(Coeff,1/ORD(Coeff)) \* Enth\_liq("7",Coeff) \*POWER(TSC402,ORD(Coeff)))) =e= 0;  
 2872 EQU1522..x1SC401 + x2SC401 + x3SC401 + x4SC401 + x5SC401 + x6SC401 + x7SC401 =e= 1;  
 2873 EQU1523..hSC401 - FSC401 \* ((x1SC401/MW1)\*(SUM(Coeff,1/ORD(Coeff)) \* Enth\_liq("1",Coeff) \*POWER(TSC401,ORD(Coeff))))  
 2874 +(x2SC401/MW2)\*(SUM(Coeff,1/ORD(Coeff)) \* Enth\_liq("2",Coeff) \*POWER(TSC401,ORD(Coeff))))  
 2875 +(x3SC401/MW3)\*(SUM(Coeff,1/ORD(Coeff)) \* Enth\_liq("3",Coeff) \* POWER(TSC401,ORD(Coeff))))  
 2876 +(x4SC401/MW4)\*(SUM(Coeff,1/ORD(Coeff)) \* Enth\_liq("4",Coeff) \*POWER(TSC401,ORD(Coeff))))  
 2877 +(x5SC401/MW5)\*(SUM(Coeff,1/ORD(Coeff)) \* Enth\_liq("5",Coeff) \*POWER(TSC401,ORD(Coeff))))  
 2878 +(x6SC401/MW6)\*(SUM(Coeff,1/ORD(Coeff)) \* Enth\_liq("6",Coeff) \*POWER(TSC401,ORD(Coeff))))  
 2879 +(x7SC401/MW7)\*(SUM(Coeff,1/ORD(Coeff)) \* Enth\_liq("7",Coeff) \*POWER(TSC401,ORD(Coeff)))) =e= 0;  
 2880 EQU1524..VpC601=e=FSC406;  
 2881 EQU1525..VpC603=e=FC323;  
 2882 EQU1526..Cost =e= FHC01 \* 143.4402\*0.9071847 + FSC414 \* 160.4628\*0.9071847 + FAC02 \* 110\*0.9071847 + FSC401 \*25;  
 2883 EQU1527..Earnings =e= FC407 \* 214.1463\*0.9071847;  
 2884 EQU1528..Utilities =e= (FstmE612 +FstmE602+ (FstmE696A+FstmE696B)) \* 1.25\*0.9071847 + (FstmE695A+ FstmE695B) \* 1.8\*0.9071847 +  
 0.67e-3 \*22.35\* WK601;  
 2885 EQU1529..Profit =e= Earnings - Cost - Utilities;  
 2886 EQU1530..hSC408 - FSC408 \*  
 2887 ((x1SC408/MW1)\*(SUM(Coeff,1/ORD(Coeff)) \* Enth\_liq("1",Coeff) \*POWER(TSC408,ORD(Coeff)))) + Enth\_Vap("1","a1")\*1000 \*  
 ((1-TSC408/Enth\_Vap("1","a2"))\*\*Enth\_Vap("1","a3"))  
 2888 +(x3SC408/MW3)\*(SUM(Coeff,1/ORD(Coeff)) \* Enth\_liq("3",Coeff) \* POWER(TSC408,ORD(Coeff)))) + Enth\_Vap("3","a1")\*1000 \*  
 ((1-TSC408/Enth\_Vap("3","a2"))\*\*Enth\_Vap("3","a3"))  
 2889 +(x4SC408/MW4)\*(SUM(Coeff,1/ORD(Coeff)) \* Enth\_liq("4",Coeff) \*POWER(TSC408,ORD(Coeff)))) + Enth\_Vap("4","a1")\*1000 \*  
 ((1-TSC408/Enth\_Vap("4","a2"))\*\*Enth\_Vap("4","a3"))  
 2890 +(x5SC408/MW5)\*(SUM(Coeff,1/ORD(Coeff)) \* Enth\_liq("5",Coeff) \*POWER(TSC408,ORD(Coeff)))) + Enth\_Vap("5","a1")\*1000 \*  
 ((1-TSC408/Enth\_Vap("5","a2"))\*\*Enth\_Vap("5","a3"))  
 \_Economic Optimization Program 05/15/01 16:49:39 PAGE 67

```

2891 +(x7SC408/MW7)*(SUM(Coeff,1/ORD(Coeff)* Enth_liq("7",Coeff) *POWER(TSC408,ORD(Coeff)))+ Enth_Vap("7","a1")*1000 *
((1-TSC408/Enth_Vap("7","a2"))**Enth_Vap("7","a3")))) =e= 0;
2892 EQU1531..hC325 - FC325 *
2893 ((x1C325/MW1)*(SUM(Coeff,1/ORD(Coeff)* Enth_liq("1",Coeff) *POWER(TC325,ORD(Coeff)))+ Enth_Vap("1","a1")*1000 *
((1-TC325/Enth_Vap("1","a2"))**Enth_Vap("1","a3"))))
2894 +(x3C325/MW3)*(SUM(Coeff,1/ORD(Coeff)* Enth_liq("3",Coeff) * POWER(TC325,ORD(Coeff)))+ Enth_Vap("3","a1")*1000 *
((1-TC325/Enth_Vap("3","a2"))**Enth_Vap("3","a3"))))
2895 +(x4C325/MW4)*(SUM(Coeff,1/ORD(Coeff)* Enth_liq("4",Coeff) *POWER(TC325,ORD(Coeff)))+ Enth_Vap("4","a1")*1000 *
((1-TC325/Enth_Vap("4","a2"))**Enth_Vap("4","a3"))))
2896 +(x5C325/MW5)*(SUM(Coeff,1/ORD(Coeff)* Enth_liq("5",Coeff) *POWER(TC325,ORD(Coeff)))+ Enth_Vap("5","a1")*1000 *
((1-TC325/Enth_Vap("5","a2"))**Enth_Vap("5","a3"))))
2897 +(x7C325/MW7)*(SUM(Coeff,1/ORD(Coeff)* Enth_liq("7",Coeff) *POWER(TC325,ORD(Coeff)))+ Enth_Vap("7","a1")*1000 *
((1-TC325/Enth_Vap("7","a2"))**Enth_Vap("7","a3")))) =e= 0;
2898 EQU1532..hSC407 - FSC407 *
2899 ((x1SC407/MW1)*(SUM(Coeff,1/ORD(Coeff)* Enth_liq("1",Coeff) *POWER(TSC407,ORD(Coeff)))))
2900 +(x2SC407/MW2)*(SUM(Coeff,1/ORD(Coeff)* Enth_liq("2",Coeff) *POWER(TSC407,ORD(Coeff)))))
2901 +(x3SC407/MW3)*(SUM(Coeff,1/ORD(Coeff)* Enth_liq("3",Coeff) * POWER(TSC407,ORD(Coeff)))))
2902 +(x4SC407/MW4)*(SUM(Coeff,1/ORD(Coeff)* Enth_liq("4",Coeff) *POWER(TSC407,ORD(Coeff)))+ Enth_Vap("4","a1")*1000 *
((1-TSC407/Enth_Vap("4","a2"))**Enth_Vap("4","a3"))))
2903 +(x5SC407/MW5)*(SUM(Coeff,1/ORD(Coeff)* Enth_liq("5",Coeff) *POWER(TSC407,ORD(Coeff)))+ Enth_Vap("5","a1")*1000 *
((1-TSC407/Enth_Vap("5","a2"))**Enth_Vap("5","a3"))))
2904 +(x6SC407/MW6)*(SUM(Coeff,1/ORD(Coeff)* Enth_liq("6",Coeff) *POWER(TSC407,ORD(Coeff)))+ Enth_Vap("6","a1")*1000 *
((1-TSC407/Enth_Vap("6","a2"))**Enth_Vap("6","a3"))))
2905 +(x7SC407/MW7)*(SUM(Coeff,1/ORD(Coeff)* Enth_liq("7",Coeff) *POWER(TSC407,ORD(Coeff)))+ Enth_Vap("7","a1")*1000 *
((1-TSC407/Enth_Vap("7","a2"))**Enth_Vap("7","a3")))) =e= 0;
2906 EQU1533..hC324 - FC324 *
2907 ((x1C324/MW1)*(SUM(Coeff,1/ORD(Coeff)* Enth_liq("1",Coeff) *POWER(TC324,ORD(Coeff)))+ Enth_Vap("1","a1")*1000 *
((1-TC324/Enth_Vap("1","a2"))**Enth_Vap("1","a3"))))
2908 +(x3C324/MW3)*(SUM(Coeff,1/ORD(Coeff)* Enth_liq("3",Coeff) * POWER(TC324,ORD(Coeff)))+ Enth_Vap("3","a1")*1000 *
((1-TC324/Enth_Vap("3","a2"))**Enth_Vap("3","a3"))))
2909 +(x4C324/MW4)*(SUM(Coeff,1/ORD(Coeff)* Enth_liq("4",Coeff) *POWER(TC324,ORD(Coeff)))+ Enth_Vap("4","a1")*1000 *
((1-TC324/Enth_Vap("4","a2"))**Enth_Vap("4","a3"))))
2910 +(x5C324/MW5)*(SUM(Coeff,1/ORD(Coeff)* Enth_liq("5",Coeff) *POWER(TC324,ORD(Coeff)))+ Enth_Vap("5","a1")*1000 *
((1-TC324/Enth_Vap("5","a2"))**Enth_Vap("5","a3"))))
2911 +(x7C324/MW7)*(SUM(Coeff,1/ORD(Coeff)* Enth_liq("7",Coeff) *POWER(TC324,ORD(Coeff)))+ Enth_Vap("7","a1")*1000 *
((1-TC324/Enth_Vap("7","a2"))**Enth_Vap("7","a3")))) =e= 0;
2912 EQU1534..x1SC403 - x1SC404 =e= 0;
2913 EQU1535..FSC403 - FSC404 =e= 0;
2914 EQU1536..x1SC401 - x1SC402 =e= 0;
2915 EQU1537..FSC401 - FSC402 =e= 0;
2916 EQU1538..(hSC403 - hSC404) - (hSC402 - hSC401) =e= 0;
2917 EQU1539..(hSC403 - hSC404) - UE601*AE601*dTE601*FE601 =e= 0;
2918 EQU1540..dTE601**3 =e= ((TSC403-TSC402)*(TSC404-TSC401)*
2919 ((TSC403-TSC402)+(TSC404-TSC401))/2);
2920 EQU1541..x2SC401 - x2SC402 =e= 0;
2921 EQU1542..x6SC403 - x6SC404 =e= 0;
_Economic Optimization Program
05/15/01 16:49:39 PAGE 68
GAMS 2.50A Windows NT/95/98

2922 EQU1543..x2SC403 - x2SC404 =e= 0;
2923 EQU1544..x6SC401 - x6SC402 =e= 0;
2924 EQU1545..x4SC403 - x4SC404 =e= 0;
2925 EQU1546..x5SC401 - x5SC402 =e= 0;
2926 EQU1547..FSC402 * x2SC402 + FSC411*x2SC411 - FSC403 * x2SC403 - FSC408*x2SC408 =e= 0;
2927 EQU1548..h6C601*K6C601*LpC601*(1-Sm6C601) =e= Kp6C601*FSC411*(1-Sn6C601);
2928 EQU1549..h2C601*K2C601*LpC601*(1-Sm2C601) =e= Kp2C601*FSC411*(1-Sn2C601);
2929 EQU1550..f6C601 * x6SC402 * FSC402 =e= x6SC403 * FSC403;
2930 EQU1551..Sn4C601 *FSC411 =e= K4C601*FSC408;
2931 EQU1552..Sn2C601 *FSC411 =e= K2C601*FSC408;
2932 EQU1553..Sm1C601*LpC601=e= Kp1C601*VpC601;
2933 EQU1554..Sn3C601 *FSC411 =e= K3C601*FSC408;
2934 EQU1555..Sn6C601 *FSC411 =e= K6C601*FSC408;
2935 EQU1556..Sn5C601 *FSC411 =e= K5C601*FSC408;
2936 EQU1557..f2C601 * x2SC402 * FSC402 =e= x2SC403 * FSC403;
2937 EQU1558..f6C601*((1-Sn6C601** (60-37))+ RC601*(1-Sn6C601) + h6C601*Sn6C601** (60-37)*(1-Sm6C601** (37+1))) =e= (1-Sn6C601** (60-37))+ RC601*(1-Sn6C601);
2938 EQU1559..f2C601*((1-Sn2C601** (60-37))+ RC601*(1-Sn2C601) + h2C601*Sn2C601** (60-37)*(1-Sm2C601** (37+1))) =e= (1-Sn2C601** (60-37))+ RC601*(1-Sn2C601);
2939 EQU1560..Sm6C601*LpC601=e= Kp6C601*VpC601;
2940 EQU1561..Sm2C601*LpC601=e= Kp2C601*VpC601;
2941 EQU1562..Sm3C601*LpC601=e= Kp3C601*VpC601;
2942 EQU1563..f7C601 * x7SC402 * FSC402 =e= x7SC403 * FSC403;
2943 EQU1564..Sm7C601*LpC601=e= Kp7C601*VpC601;
2944 EQU1565..f3C601*((1-Sn3C601** (60-37))+ RC601*(1-Sn3C601) + h3C601*Sn3C601** (60-37)*(1-Sm3C601** (37+1))) =e= (1-Sn3C601** (60-37))+ RC601*(1-Sn3C601);
2945 EQU1566..f4C601*((1-Sn4C601** (60-37))+ RC601*(1-Sn4C601) + h4C601*Sn4C601** (60-37)*(1-Sm4C601** (37+1))) =e= (1-Sn4C601** (60-37))+ RC601*(1-Sn4C601);
2946 EQU1567..f5C601*((1-Sn5C601** (60-37))+ RC601*(1-Sn5C601) + h5C601*Sn5C601** (60-37)*(1-Sm5C601** (37+1))) =e= (1-Sn5C601** (60-37))+ RC601*(1-Sn5C601);
2947 EQU1568..f7C601*((1-Sn7C601** (60-37))+ RC601*(1-Sn7C601) + h7C601*Sn7C601** (60-37)*(1-Sm7C601** (37+1))) =e= (1-Sn7C601** (60-37))+ RC601*(1-Sn7C601);
2948 EQU1569..f1C601 * x1SC402 * FSC402 =e= x1SC403 * FSC403;
2949 EQU1570..f3C601 * x3SC402 * FSC402 =e= x3SC403 * FSC403;
2950 EQU1571..FSC402 * x6SC402 + FSC411*x6SC411 - FSC403 * x6SC403 - FSC408*x6SC408 =e= 0;
2951 EQU1572..f5C601 * x5SC402 * FSC402 =e= x5SC403 * FSC403;
2952 EQU1573..Kp6C601*PC601 =e= 0.1333*10**(33.3239-2.4227E3/TmC601-9.2354*LOG10(TmC601)+9.0199E-11*TmC601+4.1050E-6*TmC601**2);
2953 EQU1574..h1C601*K1C601*LpC601*(1-Sm1C601) =e= Kp1C601*FSC411*(1-Sn1C601);
2954 EQU1575..h3C601*K3C601*LpC601*(1-Sm3C601) =e= Kp3C601*FSC411*(1-Sn3C601);

```

2955 EQU1576..h4C601\*K4C601\*LpC601\*(1-Sm4C601) =e= Kp4C601\*FSC411\*(1-Sn4C601);  
 2956 EQU1577..h5C601\*K5C601\*LpC601\*(1-Sm5C601) =e= Kp5C601\*FSC411\*(1-Sn5C601);  
 2957 EQU1578..h7C601\*K7C601\*LpC601\*(1-Sm7C601) =e= Kp7C601\*FSC411\*(1-Sn7C601);  
 2958 EQU1579..Sm5C601\*LpC601=e= Kp5C601\*VpC601;  
 2959  
 2960 INEQU1..sf1S34 + sf2S34 =l= 1;  
 2961 INEQU2..TC306 - TcwoutE634 =g= 8;  
 \_Economic Optimization Program

2962 INEQU3..TC308 - TcwoutE640 =g= 10;  
 2963 INEQU4..TC317-TC316 =g=10;  
 2964 INEQU5..TC318-TC315 =g=10;  
 2965 INEQU6..TC319-Tcwin =g=10;  
 2966 INEQU7..TC318-TcwoutE611 =g=10;  
 2967 INEQU8..414.6-TC323 =g=10;  
 2968 INEQU9..414.6-TC324 =g=10;  
 2969 INEQU10..TC326-Tcwin =g=10;  
 2970 INEQU11..TC325-TcwoutE613 =g=10;  
 2971 INEQU12..TC405-TC404 =g=10;  
 2972 INEQU13..TC406-TC403 =g=10;  
 2973 INEQU14..TC407-Tcwin =g=10;  
 2974 INEQU15..TC406-TcwoutE617 =g=10;  
 2975 INEQU16..TC414-Tcwin =g=10;  
 2976 INEQU17..TC414-TcwotE621A =g=10;  
 2977 INEQU18..TC415-Tcwin =g=10;  
 2978 INEQU19..TC414-TcwotE621B =g=10;  
 2979 INEQU20..TC419-Tcwin =g=10;  
 2980 INEQU21..TC418-TcwoutE626 =g=10;  
 2981 INEQU22..THC01-TC402 =g=10;  
 2982 INEQU23..THC02-TC401 =g=10;  
 2983 INEQU24..TC412-Tcwin =g=8;  
 2984 INEQU25..TC412-TcwotE627A =g=8;  
 2985 INEQU26..TC413-TcwotE627B =g=8;  
 2986 INEQU27..THC04-TC402 =g=8;  
 2987 INEQU28..THC03-TC403 =g=8;  
 2988 INEQU29..THC05-THC29 =g=8;  
 2989 INEQU30..THC04-THC30 =g=8;  
 2990 INEQU31..TC307-Tcwin =g=8;  
 2991 INEQU32..TC308-TcwoutE640 =g=10;  
 2992 INEQU33..TC308-Tcwin =g=10;  
 2993 INEQU34..TC308-TcwotE641A =g=10;  
 2994 INEQU35..TC309-TcwotE641B =g=10;  
 2995 INEQU36..481-TC408 =g=10;  
 2996 INEQU37..481-TC409 =g=10;  
 2997 INEQU38..414.6-TC410 =g=10;  
 2998 INEQU39..414.6-TC411 =g=10;  
 2999 INEQU40..TSC404-TSC401 =g=10;  
 3000 INEQU41..TSC403-TSC402 =g=10;  
 3001 INEQU42..414.6-TSC407 =g=10;  
 3002 INEQU43..414.6-TSC406 =g=10;  
 3003 INEQU44..TSC404-TcwoutE603 =g=10;  
 3004 INEQU45..TSC405-Tcwin =g=10;  
 3005 INEQU46..TSC408-TcwoutE605 =g=10;  
 3006 INEQU47..TSC409-Tcwin =g=10;  
 3007 INEQU48..TSC412 - TcwotE609A =g= 10;  
 \_Economic Optimization Program

3008 INEQU49..TSC413 - Tcwin =g=10;  
 3009 INEQU50..f1C601=l=0.0001;  
 3010  
 3011 FAC02.L=0.155; FAC12.L=0.155; FAC23.L=0.155;  
 3012 FAC34.L=0.155; FAC45.L=0.155; FC308.L=3.196;  
 3013 FC316.L=1.7; FC320.L=0.043; FC322.L=1.5;  
 3014 FC328.L=0.047; FC329.L=0.665; FC403.L=2.302;  
 3015 FC407.L=0.911; FC412.L=0.042; FC417.L=0.139;  
 3016 FHC01.L=0.87; FHC32.L=1.943; FSC402.L=0.484;  
 3017 FSC405.L=0.344; FSC411.L=1.273; FSC413.L=0.139;  
 3018 FstmE612.L=0.142; PC302.L=101.847; PC310.L=261.214;  
 3019 PC601.L=625; PC603.L=1703.728; QHC07.L=1.739;  
 3020 QHC11.L=1.743; QHC14.L=1.739; QHC16.L=1.739;  
 3021 QHC34.L=1.079; QHC38.L=0.581; QHC41.L=0.857;  
 3022 QHC45.L=0.862; TAC09.L=280.004; TAC12.L=280.004;  
 3023 TAC23.L=280; TAC31.L=280.105; TAC34.L=280.105;  
 3024 TAC42.L=281.963; TAC45.L=281.963; TC303.L=280.411;  
 3025 TC306.L=349.007; TC307.L=328.661; TC308.L=328.661;  
 3026 TC315.L=308.238; TC316.L=345.659; TC317.L=359;  
 3027 TC321.L=301.113; TC324.L=359; TC325.L=322.937;  
 3028 TC404.L=305; TC405.L=410; TC407.L=302.95;  
 3029 TC408.L=405; TC410.L=363.414; TC414.L=336.829;  
 3030 TC418.L=305.918; TC419.L=303.525; THC32.L=259.254;  
 3031 TSC402.L=324.98; TSC403.L=336.03; TSC405.L=301.256;  
 3032 TSC408.L=318.852; TSC413.L=300; x11AC12.L=0.971;  
 3033 x11AC23.L=0.944; x11AC34.L=0.917; x11AC45.L=0.89;  
 3034 x1C316.L=0.119; x1C325.L=1; x1C417.L=0.02;  
 3035 x1HC32.L=0.023; x1SC402.L=0.006; x1SC403.L=0.0000081;  
 3036 x1SC408.L=0.02; x2SC402.L=0.009; x2SC403.L=0.012;  
 3037 x2SC408.L=0.00031; x3C316.L=0.79; x3C325.L=0.00000166;  
 3038 x3C417.L=0.967; x3HC32.L=0.774; x3SC402.L=0.293;

3039 x3SC403.L=0.021; x3SC408.L=0.967; x4C316.L=0.08;  
3040 x4C417.L=0.013; x4HC32.L=0.127; x4SC402.L=0.562;  
3041 x4SC403.L=0.784; x4SC408.L=0.013; x5C316.L=0.006;  
3042 x5C417.L=0; x5HC32.L=0.03; x5SC402.L=0.052;  
3043 x5SC403.L=0.073; x5SC408.L=0; x6SC402.L=0.071;  
3044 x6SC403.L=0.1; x6SC408.L=0; x7HC32.L=0.046;  
3045 x7SC402.L=0.007; x7SC403.L=0.01; x7SC408.L=0;  
3046 xx1C322.L=0.12; xx1C414.L=0.079; xx1HC01.L=0.09;  
3047 xx2HC01.L=0.13; xx3C317.L=0.792; xx3C322.L=0.792;  
3048 xx3C407.L=0.00000975; xx3C412.L=0.000875; xx3C414.L=0.818;  
3049 xx3HC01.L=0.013; xx4C317.L=0.08; xx4C322.L=0.08;  
3050 xx4C407.L=0.083; xx4C412.L=0.867; xx4C414.L=0.094;  
3051 xx4HC01.L=0.107; xx5C407.L=0.158; xx5C412.L=0.061;  
3052 xx5C414.L=0.001; xx7C414.L=0.008;  
3053 FAC02.LO=0.09; FAC12.LO=0.01; FAC23.LO=0.01;  
\_Economic Optimization Program

05/15/01 16:49:39 PAGE 71  
GAMS 2.50A Windows NT/95/98

3054 FAC34.LO=0.01; FAC45.LO=0.01; FC308.LO=1;  
3055 FC316.LO=0.1; FC320.LO=0.01; FC322.LO=0.1;  
3056 FC328.LO=0.01; FC329.LO=0.1; FC403.LO=0.1;  
3057 FC407.LO=0.75; FC412.LO=0.01; FC417.LO=0.1;  
3058 FHC01.LO=0.795; FHC32.LO=0.5; FSC402.LO=0.1;  
3059 FSC405.LO=0; FSC411.LO=0.1; FSC413.LO=0.1;  
3060 FstmE612.LO=0.05; PC302.LO=101; PC310.LO=230;  
3061 PC601.LO=600; PC603.LO=1600; QHC07.LO=0.1;  
3062 QHC11.LO=0.1; QHC14.LO=0.1; QHC16.LO=0.1;  
3063 QHC34.LO=0.1; QHC38.LO=0.1; QHC41.LO=0.1;  
3064 QHC45.LO=0.1; TAC09.LO=280; TAC12.LO=280;  
3065 TAC23.LO=280; TAC31.LO=280; TAC34.LO=280;  
3066 TAC42.LO=280; TAC45.LO=280; TC303.LO=260;  
3067 TC306.LO=320; TC307.LO=300; TC308.LO=270;  
3068 TC315.LO=300; TC316.LO=335; TC317.LO=300;  
3069 TC321.LO=250; TC324.LO=359; TC325.LO=300;  
3070 TC404.LO=305; TC405.LO=410; TC407.LO=298;  
3071 TC408.LO=405; TC410.LO=345; TC414.LO=300;  
3072 TC418.LO=301; TC419.LO=298; THC32.LO=250;  
3073 TSC402.LO=310; TSC403.LO=320; TSC405.LO=300;  
3074 TSC408.LO=300; TSC413.LO=295; x11AC12.LO=0.88;  
3075 x11AC23.LO=0.88; x11AC34.LO=0.88; x11AC45.LO=0.88;  
3076 x1C316.LO=0.01; x1C325.LO=0.5; x1C417.LO=0.02;  
3077 x1HC32.LO=0; x1SC402.LO=0; x1SC403.LO=0;  
3078 x1SC408.LO=0; x2SC402.LO=0; x2SC403.LO=0;  
3079 x2SC408.LO=0; x3C316.LO=0.5; x3C325.LO=0;  
3080 x3C417.LO=0.35; x3HC32.LO=0.1; x3SC402.LO=0.2;  
3081 x3SC403.LO=0; x3SC408.LO=0.5; x4C316.LO=0.001;  
3082 x4C417.LO=0.001; x4HC32.LO=0; x4SC402.LO=0.48;  
3083 x4SC403.LO=0.5; x4SC408.LO=0; x5C316.LO=0;  
3084 x5C417.LO=0; x5HC32.LO=0; x5SC402.LO=0;  
3085 x5SC403.LO=0; x5SC408.LO=0; x6SC402.LO=0;  
3086 x6SC403.LO=0; x6SC408.LO=0; x7HC32.LO=0;  
3087 x7SC402.LO=0; x7SC403.LO=0; x7SC408.LO=0;  
3088 xx1C322.LO=0; xx1C414.LO=0; xx1HC01.LO=0;  
3089 xx2HC01.LO=0.1; xx3C317.LO=0.5; xx3C322.LO=0.5;  
3090 xx3C407.LO=0; xx3C412.LO=0; xx3C414.LO=0.5;  
3091 xx3HC01.LO=0; xx4C317.LO=0; xx4C322.LO=0;  
3092 xx4C407.LO=0.01; xx4C412.LO=0.5; xx4C414.LO=0;  
3093 xx4HC01.LO=0; xx5C407.LO=0.01; xx5C412.LO=0;  
3094 xx5C414.LO=0; xx7C414.LO=0;  
3095 FAC02.UP=0.16; FAC12.UP=0.9; FAC23.UP=0.9;  
3096 FAC34.UP=0.9; FAC45.UP=0.9; FC308.UP=6;  
3097 FC316.UP=1.8; FC320.UP=1.5; FC322.UP=1.6;  
3098 FC328.UP=1; FC329.UP=3; FC403.UP=5;  
3099 FC407.UP=5; FC412.UP=1; FC417.UP=2;  
\_Economic Optimization Program

05/15/01 16:49:39 PAGE 72  
GAMS 2.50A Windows NT/95/98

3100 FHC01.UP=1.5; FHC32.UP=5; FSC402.UP=4;  
3101 FSC405.UP=3; FSC411.UP=3.2; FSC413.UP=0.5;  
3102 FstmE612.UP=1; PC302.UP=187; PC310.UP=360;  
3103 PC601.UP=625; PC603.UP=1800; QHC07.UP=5;  
3104 QHC11.UP=5; QHC14.UP=5; QHC16.UP=5;  
3105 QHC34.UP=5; QHC38.UP=5; QHC41.UP=5;  
3106 QHC45.UP=5; TAC09.UP=300; TAC12.UP=300;  
3107 TAC23.UP=300; TAC31.UP=300; TAC34.UP=300;  
3108 TAC42.UP=300; TAC45.UP=300; TC303.UP=300;  
3109 TC306.UP=368; TC307.UP=330; TC308.UP=350;  
3110 TC315.UP=320; TC316.UP=370; TC317.UP=420;  
3111 TC321.UP=350; TC324.UP=385; TC325.UP=360;  
3112 TC404.UP=325; TC405.UP=440; TC407.UP=350;  
3113 TC408.UP=440; TC410.UP=369; TC414.UP=368;  
3114 TC418.UP=350; TC419.UP=310; THC32.UP=310;  
3115 TSC402.UP=340; TSC403.UP=350; TSC405.UP=360;  
3116 TSC408.UP=330; TSC413.UP=350; x11AC12.UP=0.999;  
3117 x11AC23.UP=0.999; x11AC34.UP=0.999; x11AC45.UP=0.999;  
3118 x1C316.UP=0.5; x1C325.UP=1; x1C417.UP=0.2;  
3119 x1HC32.UP=0.1; x1SC402.UP=0.1; x1SC403.UP=0.1;  
3120 x1SC408.UP=0.1; x2SC402.UP=0.1; x2SC403.UP=0.1;  
3121 x2SC408.UP=0.1; x3C316.UP=1; x3C325.UP=0.1;  
3122 x3C417.UP=1; x3HC32.UP=1; x3SC402.UP=0.42;

3123 x3SC403.UP=0.1; x3SC408.UP=1; x4C316.UP=0.2;  
3124 x4C417.UP=0.4; x4HC32.UP=0.5; x4SC402.UP=0.7;  
3125 x4SC403.UP=1; x4SC408.UP=0.1; x5C316.UP=0.01;  
3126 x5C417.UP=0.15; x5HC32.UP=2.5; x5SC402.UP=0.1;  
3127 x5SC403.UP=0.1; x5SC408.UP=0.1; x6SC402.UP=0.1;  
3128 x6SC403.UP=0.12; x6SC408.UP=0.1; x7HC32.UP=2;  
3129 x7SC402.UP=0.1; x7SC403.UP=0.1; x7SC408.UP=0.1;  
3130 xx1C322.UP=0.12; xx1C414.UP=0.08; xx1HC01.UP=0.5;  
3131 xx2HC01.UP=0.6; xx3C317.UP=1; xx3C322.UP=1;  
3132 xx3C407.UP=0.1; xx3C412.UP=0.15; xx3C414.UP=1;  
3133 xx3HC01.UP=0.55; xx4C317.UP=0.2; xx4C322.UP=0.2;  
3134 xx4C407.UP=0.3; xx4C412.UP=1; xx4C414.UP=0.2;  
3135 xx4HC01.UP=0.3; xx5C407.UP=0.5; xx5C412.UP=0.1;  
3136 xx5C414.UP=0.1; xx7C414.UP=0.008;  
3137  
3138 C10pC623.L=0.0000338; C10pC625.L=0.0000735; C10pC627.L=0.000214;  
3139 C10pC629.L=0.000152; C2C623.L=0.015; C2C625.L=0.015;  
3140 C2C627.L=0.015; C2C629.L=0.015; C3C623.L=3.85;  
3141 C3C625.L=2.584; C3C627.L=1.5; C3C629.L=1.801;  
3142 C3pC623.L=1.173; C3pC625.L=1.198; C3pC627.L=1.215;  
3143 C3pC629.L=1.19; C4pC623.L=0.027; C4pC625.L=0.041;  
3144 C4pC627.L=0.071; C4pC629.L=0.058; C5pC623.L=0.000408;  
3145 C5pC625.L=0.00091; C5pC627.L=0.003; C5pC629.L=0.002;  
\_Economic Optimization Program

3146 C7pC623.L=0.0000378; C7pC625.L=0.000179; C7pC627.L=0.001;  
3147 C7pC629.L=0.000743; C8pC623.L=0.001; C8pC625.L=0.003;  
3148 C8pC627.L=0.01; C8pC629.L=0.007; C9pC623.L=0.419;  
3149 C9pC625.L=0.625; C9pC627.L=1.074; C9pC629.L=0.895;  
3150 CHXC623.L=13.606; CHXC625.L=14.201; CHXC627.L=14.702;  
3151 CHXC629.L=14.035; CiC10pC623.L=0; CiC10pC625.L=0;  
3152 CiC10pC627.L=0; CiC10pC629.L=0; CiC11pC623.L=0.0000132;  
3153 CiC11pC625.L=0.000042; CiC11pC627.L=0.000202; CiC11pC629.L=0.000121;  
3154 CiC4eC623.L=0.003; CiC4eC625.L=0.003; CiC4eC627.L=0.003;  
3155 CiC4eC629.L=0.003; CiC5eC623.L=0.000594; CiC5eC625.L=0.00085;  
3156 CiC5eC627.L=0.001; CiC5eC629.L=0.001; CiC8eC623.L=0.018;  
3157 CiC8eC625.L=0.026; CiC8eC627.L=0.044; CiC8eC629.L=0.037;  
3158 Cost.L=148.943; dTE601.L=10.516; dTE602.L=78.57;  
3159 dTE603.L=10.825; dTE605.L=22.741; dTE609A.L=10;  
3160 dTE610.L=13.533; dTE611.L=16.018; dTE612.L=55.6;  
3161 dTE613.L=25; dTE616.L=98.994; dTE617.L=33.53;  
3162 dTE621A.L=28.414; dTE621B.L=25.722; dTE626.L=11.674;  
3163 dTE627A.L=55; dTE627B.L=31.592; dTE628.L=10.806;  
3164 dTE629.L=16.246; dTE633.L=11.452; dTE634.L=19.324;  
3165 dTE640.L=25.062; dTE641.L=16.152; dTE695A.L=76;  
3166 dTE695B.L=48; dTE696A.L=51.186; dTE696B.L=30.593;  
3167 dTE6XX.L=1; Earnings.L=176.97; f1C601.L=0.001;  
3168 f1C603.L=0.765; f1C606A.L=0.001; f2C601.L=0.99;  
3169 f3C601.L=0.05; f3C603.L=1; f3C606A.L=0.000997;  
3170 f4C601.L=0.994; f4C603.L=1; f4C606A.L=0.898;  
3171 f5C601.L=1; f5C603.L=1; f5C606A.L=0.989;  
3172 f6C601.L=1; f7C601.L=1; f7C603.L=1;  
3173 f7C606A.L=0.999; FAC05.L=6.653; FAC07.L=6.808;  
3174 FAC09.L=8.428; FAC15.L=8.574; FAC18.L=8.729;  
3175 FAC20.L=10.065; FAC26.L=18.057; FAC29.L=18.212;  
3176 FAC31.L=19.705; FAC37.L=14.803; FAC40.L=14.958;  
3177 FAC42.L=16.454; FC301.L=3.643; FC302.L=0.428;  
3178 FC303.L=4.071; FC306.L=4.896; FC307.L=4.896;  
3179 FC309.L=3.196; FC310.L=0.825; FC311.L=2.371;  
3180 FC312.L=1.7; FC315.L=1.7; FC317.L=1.653;  
3181 FC318.L=1.653; FC319.L=1.653; FC321.L=0.11;  
3182 FC323.L=0.712; FC324.L=0.712; FC325.L=0.712;  
3183 FC326.L=0.712; FC401.L=2.302; FC402.L=2.302;  
3184 FC404.L=2.302; FC405.L=0.911; FC406.L=0.911;  
3185 FC408.L=3.271; FC409.L=3.271; FC410.L=0.833;  
3186 FC411.L=0.833; FC413.L=0.042; FC414.L=2.883;  
3187 FC415.L=2.883; FC418.L=3.023; FC419.L=3.023;  
3188 FC425.L=3.767; FC426.L=2.934; FC427.L=2.856;  
3189 FC428.L=2.023; FC430.L=3.767; FC431.L=2.856;  
3190 FC432.L=2.814; FcwE603.L=0.199; FcwE605.L=0.949;  
3191 FcwE609A.L=0.083; FcwE611.L=2.139; FcwE613.L=1.618;  
\_Economic Optimization Program

3192 FcwE617.L=1.551; FcwE621A.L=5.225; FcwE621B.L=6.898;  
3193 FcwE626.L=0.724; FcwE627A.L=0.55; FcwE627B.L=0.536;  
3194 FcwE634.L=7.241; FcwE640.L=0.4; FcwE641A.L=4.111;  
3195 FcwE641B.L=0.881; FHC02.L=0.87; FHC03.L=3.132;  
3196 FHC04.L=3.132; FHC05.L=3.132; FHC06.L=4.002;  
3197 FHC07.L=1; FHC08.L=3.002; FHC11.L=1.002;  
3198 FHC14.L=1; FHC15.L=2; FHC16.L=1;  
3199 FHC22.L=1.496; FHC23.L=1.493; FHC24.L=2.989;  
3200 FHC25.L=1.336; FHC26.L=4.325; FHC27.L=1.62;  
3201 FHC28.L=5.945; FHC29.L=0.679; FHC30.L=0.679;  
3202 FHC31.L=5.945; FHC33.L=0.954; FHC34.L=0.62;  
3203 FHC38.L=0.334; FHC40.L=0.989; FHC41.L=0.493;  
3204 FHC45.L=0.496; FIHC28.L=3.019; FIHC29.L=0.345;  
3205 FIHC30.L=0.198; FIHC31.L=2.302; FIR1.L=2.675;  
3206 FIR29.L=2.105; FmC302.L=0.007; FmC308.L=0.055;

3207 FmC310.L=0.015; FmC311.L=0.04; FmC312.L=0.03;  
3208 FmC317.L=0.029; FmC322.L=0.027; FmC323.L=0.013;  
3209 FmC325.L=0.016; FmC405.L=0.011; FmC407.L=0.011;  
3210 FmC408.L=0.04; FmC409.L=0.04; FmC412.L=0.000684;  
3211 FmC414.L=0.05; FmC425.L=0.056; FmC427.L=0.045;  
3212 FmC428.L=0.032; FmC430.L=0.058; FmC431.L=0.047;  
3213 FmC432.L=0.046; FmHC01.L=0.012; FmHC32.L=0.033;  
3214 FmIHC28.L=0.047; FmIHC29.L=0.005; FmIHC30.L=0.003;  
3215 FmIR1.L=0.042; FmIR29.L=0.032; FmSC403.L=0.006;  
3216 FmSC406.L=0.023; FmSC408.L=0.024; FmvHC28.L=0.051;  
3217 FmvHC29.L=0.006; FmvHC30.L=0.008; FmvR1.L=0.045;  
3218 FmvR29.L=0.055; FR1.L=5.266; FR29.L=5.266;  
3219 FSC401.L=0.484; FSC403.L=0.344; FSC404.L=0.344;  
3220 FSC406.L=1.412; FSC407.L=1.412; FSC408.L=1.412;  
3221 FSC409.L=1.412; FSC412.L=0.139; FSC414.L=0;  
3222 FstmE602.L=0.401; FstmE695A.L=0.409; FstmE695B.L=0.1;  
3223 FstmE696A.L=0.111; FstmE696B.L=0.019; FvHC28.L=2.926;  
3224 FvHC29.L=0.334; FvHC30.L=0.481; FvHC31.L=3.643;  
3225 FvR1.L=2.592; FvR29.L=3.162; h1C601.L=1.083;  
3226 h1C603.L=-0.308; h1C606A.L=0.988; h2C601.L=0.551;  
3227 h3C601.L=3.047; h3C603.L=0.237; h3C606A.L=-65;  
3228 h4C601.L=0.576; h4C603.L=0.303; h4C606A.L=0;  
3229 h5C601.L=0.893; h5C603.L=0.4; h5C606A.L=0.484;  
3230 h6C601.L=0.919; h7C601.L=0.963; h7C603.L=0.466;  
3231 h7C606A.L=0.548; hAC02.L=9.363; hAC05.L=345.67;  
3232 hAC07.L=355.032; hAC09.L=1238.893; hAC12.L=8.054;  
3233 hAC15.L=381.455; hAC18.L=389.509; hAC20.L=1095.317;  
3234 hAC23.L=6.896; hAC26.L=712.123; hAC29.L=719.019;  
3235 hAC31.L=1498.7; hAC34.L=6.108; hAC37.L=550.6;  
3236 hAC40.L=556.708; hAC42.L=1479.085; hacAC09.L=400.225;  
3237 hacAC20.L=404.239; hacAC31.L=725.831; hacAC42.L=698.262;  
\_Economic Optimization Program

05/15/01 16:49:39 PAGE 75  
GAMS 2.50A Windows NT/95/98

3238 hC301.L=3202.309; hC302.L=362.16; hC303.L=3564.469;  
3239 hC306.L=4694.871; hC307.L=3144.814; hC308.L=2047.223;  
3240 hC309.L=2011.834; hC310.L=732.158; hC311.L=1279.676;  
3241 hC312.L=1592.117; hC312liq.L=1097.591; hC315.L=1007.31;  
3242 hC316.L=1177.087; hC317.L=1206.034; hC318.L=1036.258;  
3243 hC319.L=948.614; hC321.L=63.005; hC322.L=861.064;  
3244 hC323.L=519.83; hC324.L=824.202; hC325.L=576.997;  
3245 hC326.L=469.229; hC329.L=437.948; hC401.L=1191.06;  
3246 hC402.L=1195.852; hC403.L=1256.207; hC404.L=1308.674;  
3247 hC405.L=732.132; hC406.L=679.665; hC407.L=494.768;  
3248 hC408.L=2583.757; hC408vap.L=3369.113; hC409.L=3561.113;  
3249 hC410.L=589.132; hC410vap.L=826.439; hC411.L=866.516;  
3250 hC412.L=41.665; hC412liq.L=30.115; hC413.L=23.373;  
3251 hC414.L=2726.349; hC414liq.L=1918.758; hC415.L=1687.138;  
3252 hC417.L=79.433; hC418.L=1766.572; hC419.L=1748.594;  
3253 hC425.L=2663.701; hC426.L=2074.569; hC427.L=2889.353;  
3254 hC428.L=2022.838; hC430.L=2637.618; hC431.L=2855.907;  
3255 hC432.L=2814.242; hC623.L=54.051; hC625.L=10;  
3256 hC627.L=10; hC629.L=151.308; hHC01.L=454.527;  
3257 hHC02.L=449.735; hHC03.L=1811.6; hHC04.L=1751.245;  
3258 hHC05.L=1699.117; hHC06.L=2148.851; hHC07.L=536.914;  
3259 hHC11.L=538.109; hHC14.L=536.914; hHC16.L=536.914;  
3260 hHC29.L=469.914; hHC30.L=522.042; hHC31.L=4393.369;  
3261 hHC32.L=917.516; hHC34.L=292.895; hHC38.L=157.699;  
3262 hHC41.L=232.767; hHC45.L=234.155; hIHC29.L=177.154;  
3263 hIHC30.L=100.685; hIHC31.L=1191.06; hIR1.L=1374.506;  
3264 hIR29.L=1077.84; hR1.L=3645.969; hR29.L=3871.327;  
3265 hSC401.L=298.275; hSC402.L=301.683; hSC403.L=223.217;  
3266 hSC404.L=219.81; hSC405.L=193.288; hSC406.L=915.321;  
3267 hSC407.L=1775.662; hSC408.L=921.092; hSC409.L=872.425;  
3268 hSC411.L=786.391; hSC412.L=86.033; hSC413.L=79.433;  
3269 hSC414.L=0; hvHC29.L=292.759; hvHC30.L=421.357;  
3270 hvHC31.L=3202.309; hvR1.L=2271.462; hvR29.L=2793.488;  
3271 K1C323.L=2.018; K1C325.L=1; K1C408.L=7.956;  
3272 K1C414.L=2.523; K1C428.L=4.259; K1C430.L=3.799;  
3273 K1C601.L=2.666; K1C603.L=1.267; K1C606A.L=1.812;  
3274 K1C606C.L=4.173; K1C614B.L=2.98; K1C615\_A.L=2.404;  
3275 K1C616\_A.L=2.852; K1E633.L=4.427; K1E6XX.L=3.982;  
3276 K1SC406.L=3.576; K1SC408.L=2.493; K2C601.L=0.784;  
3277 K2E633.L=1.253; K2E6XX.L=1.127; K2SC406.L=1.122;  
3278 K2SC408.L=0.723; K3C323.L=0.887; K3C325.L=0.401;  
3279 K3C408.L=3.836; K3C414.L=1.052; K3C428.L=1.897;  
3280 K3C430.L=1.668; K3C601.L=1.067; K3C603.L=0.525;  
3281 K3C606A.L=0.723; K3C606C.L=1.851; K3C614B.L=0.93;  
3282 K3C615\_A.L=0.981; K3C616\_A.L=1.021; K3E633.L=1.492;  
3283 K3E6XX.L=1.342; K3SC406.L=1.488; K3SC408.L=0.989;  
\_Economic Optimization Program

05/15/01 16:49:39 PAGE 76  
GAMS 2.50A Windows NT/95/98

3284 K4C323.L=0.673; K4C325.L=0.29; K4C408.L=3.023;  
3285 K4C414.L=0.776; K4C428.L=1.45; K4C430.L=1.266;  
3286 K4C601.L=0.769; K4C603.L=0.386; K4C606A.L=0.52;  
3287 K4C606C.L=1.413; K4C614B.L=0.58; K4C615\_A.L=0.708;  
3288 K4C616\_A.L=0.686; K4E633.L=0.978; K4E6XX.L=0.88;  
3289 K4SC406.L=1.096; K4SC408.L=0.709; K5C323.L=0.308;  
3290 K5C325.L=0.12; K5C408.L=1.509; K5C414.L=0.335;

3291 K5C428.L=0.673; K5C430.L=0.579; K5C601.L=0.317;  
 3292 K5C603.L=0.165; K5C606A.L=0.213; K5C606C.L=0.653;  
 3293 K5C614B.L=0.162; K5C615\_A.L=0.272; K5C616\_A.L=0.225;  
 3294 K5E633.L=0.334; K5E6XX.L=0.301; K5SC406.L=0.472;  
 3295 K5SC408.L=0.289; K6C601.L=0.247; K6SC406.L=0.375;  
 3296 K6SC408.L=0.224; K7C323.L=0.12; K7C325.L=0.04;  
 3297 K7C408.L=0.674; K7C414.L=0.12; K7C428.L=0.268;  
 3298 K7C430.L=0.226; K7C601.L=0.105; K7C603.L=0.058;  
 3299 K7C606A.L=0.071; K7C614B.L=0.039; K7C615\_A.L=0.103;  
 3300 K7C616\_A.L=0.068; K7E633.L=0.081; K7E6XX.L=0.073;  
 3301 K7SC406.L=0.168; K7SC408.L=0.095; Kp1C601.L=3.197;  
 3302 Kp1C603.L=1.79; Kp1C606A.L=2.282; Kp1C606D.L=6.131;  
 3303 Kp2C601.L=0.979; Kp3C601.L=1.311; Kp3C603.L=0.775;  
 3304 Kp3C606A.L=0.939; Kp3C606D.L=2.859; Kp4C601.L=0.958;  
 3305 Kp4C603.L=0.584; Kp4C606A.L=0.688; Kp4C606D.L=2.23;  
 3306 Kp5C601.L=0.406; Kp5C603.L=0.263; Kp5C606A.L=0.292;  
 3307 Kp5C606D.L=1.082; Kp6C601.L=0.32; Kp7C601.L=0.141;  
 3308 Kp7C603.L=0.1; Kp7C606A.L=0.102; Kp7C606D.L=0.462;  
 3309 kWad1.L=171.048; kWad2.L=288.952; LpC601.L=1.757;  
 3310 LpC603.L=2.365; LpC606A.L=2.651; PC303.L=101;  
 3311 PC306.L=870; PC307.L=800; PC308.L=800;  
 3312 PC309.L=780; PC311.L=261.214; PC312.L=800;  
 3313 PHC30.L=121.513; PHC32.L=101.847; PR29.L=135.084;  
 3314 Profit.L=20; Q2HC07.L=0.035; Q2HC11.L=0.035;  
 3315 Q2HC14.L=0.035; Q2HC16.L=0.035; qFp1C606A.L=0.007;  
 3316 qFp3C606A.L=0.00098; qFp4C606A.L=0.865; qFp5C606A.L=0.6;  
 3317 qFp7C606A.L=0.278; qS1C606A.L=0.796; qS3C606A.L=0.509;  
 3318 qS4C606A.L=0.046; qS5C606A.L=0.027; qS7C606A.L=0.008;  
 3319 r10C623.L=0; r10C625.L=0; r10C627.L=0.0000137;  
 3320 r10C629.L=0.00000117; r2C623.L=0.009; r2C625.L=0.009;  
 3321 r2C627.L=0.009; r2C629.L=0.009; r3C623.L=0.01;  
 3322 r3C625.L=0.01; r3C627.L=0.01; r3C629.L=0.01;  
 3323 r4C623.L=0.001; r4C625.L=0.001; r4C627.L=0.001;  
 3324 r4C629.L=0.001; r5C623.L=0.0000781; r5C625.L=0.0000117;  
 3325 r5C627.L=0.0000201; r5C629.L=0.0000167; r7C623.L=0;  
 3326 r7C625.L=0; r7C627.L=0; r7C629.L=0;  
 3327 r8C623.L=0.00000817; r8C625.L=0.0000121; r8C627.L=0.0000203;  
 3328 r8C629.L=0.000017; r9C623.L=0.009; r9C625.L=0.009;  
 3329 r9C627.L=0.009; r9C629.L=0.009; rho2HC07.L=650;  
 \_Economic Optimization Program

05/15/01 16:49:39 PAGE 77  
GAMS 2.50A Windows NT/95/98

3330 rho2HC11.L=650; rho2HC14.L=650; rho2HC16.L=650;  
 3331 rhoAC09.L=1700; rhoAC20.L=1700; rhoAC31.L=1700;  
 3332 rhoAC42.L=1700; riC10C623.L=0; riC10C625.L=0;  
 3333 riC10C627.L=0; riC10C629.L=0; riC11C623.L=0;  
 3334 riC11C625.L=0; riC11C627.L=0.00000114; riC11C629.L=0;  
 3335 sf1S34.L=0.026; sf2S34.L=0.066; sfS11.L=0.5;  
 3336 sfS19.L=0.491; sfS2.L=0.886; sfS23.L=0.65;  
 3337 sfS27.L=0.499; sfS41.L=0.985; sfS42.L=0.779;  
 3338 sfS5.L=0.25; sfS7.L=0.334; Sm1C601.L=2.57;  
 3339 Sm1C603.L=0.539; Sm1C606A.L=2.422; Sm1C606D.L=2.936;  
 3340 Sm2C601.L=0.787; Sm3C601.L=1.054; Sm3C603.L=0.233;  
 3341 Sm3C606A.L=0.997; Sm3C606D.L=1.308; Sm4C601.L=0.77;  
 3342 Sm4C603.L=0.176; Sm4C606A.L=0.73; Sm4C606D.L=1;  
 3343 Sm5C601.L=0.326; Sm5C603.L=0.079; Sm5C606A.L=0.31;  
 3344 Sm5C606D.L=0.464; Sm6C601.L=0.257; Sm7C601.L=0.113;  
 3345 Sm7C603.L=0.03; Sm7C606A.L=0.108; Sm7C606D.L=0.185;  
 3346 Sn1C601.L=2.958; Sn1C603.L=1.358; Sn1C606A.L=3.483;  
 3347 Sn2C601.L=0.87; Sn3C601.L=1.184; Sn3C603.L=0.562;  
 3348 Sn3C606A.L=1.39; Sn4C601.L=0.853; Sn4C603.L=0.413;  
 3349 Sn4C606A.L=1; Sn5C601.L=0.351; Sn5C603.L=0.177;  
 3350 Sn5C606A.L=0.41; Sn6C601.L=0.274; Sn7C601.L=0.117;  
 3351 Sn7C603.L=0.062; Sn7C606A.L=0.136; TAC02.L=276;  
 3352 TAC05.L=280.004; TAC07.L=279.99; TAC15.L=280;  
 3353 TAC18.L=280.063; TAC20.L=280; TAC26.L=280.105;  
 3354 TAC29.L=280.224; TAC37.L=281.963; TAC40.L=281.981;  
 3355 TC301.L=282.932; TC302.L=259.254; TC309.L=324.429;  
 3356 TC310.L=288.704; TC311.L=288.704; TC312.L=328.661;  
 3357 TC318.L=321.965; TC319.L=301.113; TC320.L=301.113;  
 3358 TC322.L=301.113; TC323.L=359; TC326.L=322.937;  
 3359 TC328.L=322.937; TC329.L=322.937; TC401.L=282.932;  
 3360 TC402.L=283.85; TC403.L=295.279; TC406.L=388.5;  
 3361 TC409.L=461; TC411.L=404.6; TC412.L=363.414;  
 3362 TC413.L=301; TC415.L=305.99; TC417.L=299.989;  
 3363 TC425.L=363.414; TC426.L=363.414; TC427.L=375.65;  
 3364 TC428.L=365.245; TC430.L=358.683; TC431.L=363.414;  
 3365 TC432.L=363.414; TcwotE609A.L=308.852; TcwotE621A.L=326.829;  
 3366 TcwotE621B.L=298; TcwotE627A.L=295; TcwotE627B.L=293;  
 3367 TcwotE641A.L=318.661; TcwotE641B.L=314.429; TcwoutE603.L=321.814;  
 3368 TcwoutE605.L=302.221; TcwoutE611.L=299.764; TcwoutE613.L=305.874;  
 3369 TcwoutE617.L=318.399; TcwoutE626.L=295.918; TcwoutE634.L=341.007;  
 3370 TcwoutE640.L=311.08; THC01.L=295.504; THC02.L=292.932;  
 3371 THC03.L=303.279; THC04.L=295.426; THC05.L=288.522;  
 3372 THC06.L=289.396; THC07.L=289.396; THC11.L=289.396;  
 3373 THC14.L=289.396; THC16.L=289.396; THC22.L=281.963;  
 3374 THC23.L=280.105; THC24.L=281.035; THC25.L=280;  
 3375 THC26.L=280.715; THC27.L=280.004; THC28.L=280.522;  
 \_Economic Optimization Program

05/15/01 16:49:39 PAGE 78  
GAMS 2.50A Windows NT/95/98

3376 THC29.L=280.522; THC30.L=280.522; THC31.L=282.932;  
 3377 THC34.L=259.254; THC38.L=259.254; THC41.L=259.254;  
 3378 THC45.L=259.254; TmC601.L=330.505; TmC603.L=352.33;  
 3379 TmC606A.L=331.841; TmC606D.L=387.623; TmK601.L=306.796;  
 3380 TnC601.L=321.916; TnC603.L=334.298; TnC606A.L=320.914;  
 3381 TR1.L=280.522; TR29.L=280.522; TSC401.L=322.219;  
 3382 TSC404.L=332.219; TSC406.L=336.03; TSC407.L=336.03;  
 3383 TSC409.L=318.852; TSC411.L=318.852; TSC412.L=318.852;  
 3384 TSC414.L=320; Utilities.L=8.027; VFC614B.L=0.181;  
 3385 VFC615.L=0.347; VFC616.L=0.258; VFM3.L=0.492;  
 3386 VpC601.L=1.412; VpC603.L=0.712; VpC606A.L=2.814;  
 3387 x10AC09.L=0; x10AC20.L=0; x10AC31.L=0;  
 3388 x10AC42.L=0; x11AC02.L=0.998; x11AC05.L=0.971;  
 3389 x11AC07.L=0.972; x11AC09.L=0.784; x11AC15.L=0.944;  
 3390 x11AC18.L=0.944; x11AC20.L=0.819; x11AC26.L=0.917;  
 3391 x11AC29.L=0.917; x11AC31.L=0.848; x11AC37.L=0.89;  
 3392 x11AC40.L=0.89; x11AC42.L=0.809; x12AC02.L=0.002;  
 3393 x12AC05.L=0.029; x12AC07.L=0.028; x12AC09.L=0.023;  
 3394 x12AC12.L=0.029; x12AC15.L=0.056; x12AC18.L=0.056;  
 3395 x12AC20.L=0.049; x12AC23.L=0.056; x12AC26.L=0.083;  
 3396 x12AC29.L=0.083; x12AC31.L=0.077; x12AC34.L=0.083;  
 3397 x12AC37.L=0.11; x12AC40.L=0.11; x12AC42.L=0.1;  
 3398 x12AC45.L=0.11; x1AC09.L=0.009; x1AC20.L=0.007;  
 3399 x1AC31.L=0.004; x1AC42.L=0.004; x1C301.L=0.068;  
 3400 x1C302.L=0.069; x1C303.L=0.068; x1C306.L=0.072;  
 3401 x1C307.L=0.072; x1C308.L=0.048; x1C309.L=0.048;  
 3402 x1C310.L=0.094; x1C311.L=0.031; x1C312.L=0.119;  
 3403 x1C315.L=0.119; x1C317.L=0.094; x1C318.L=0.094;  
 3404 x1C319.L=0.094; x1C320.L=0.094; x1C321.L=0.094;  
 3405 x1C322.L=0.094; x1C323.L=0.094; x1C324.L=0.094;  
 3406 x1C326.L=1; x1C328.L=1; x1C329.L=1;  
 3407 x1C401.L=0.015; x1C402.L=0.015; x1C403.L=0.015;  
 3408 x1C404.L=0.015; x1C405.L=0; x1C406.L=0;  
 3409 x1C407.L=0; x1C408.L=0; x1C409.L=0;  
 3410 x1C410.L=0.0001; x1C411.L=0.0001; x1C412.L=0.000463;  
 3411 x1C413.L=0.000463; x1C414.L=0.061; x1C415.L=0.061;  
 3412 x1C418.L=0.059; x1C419.L=0.059; x1C425.L=0.0001;  
 3413 x1C426.L=0.0001; x1C427.L=0.000132; x1C428.L=0.000145;  
 3414 x1C430.L=0.0000468; x1C431.L=0.000463; x1C432.L=0.000463;  
 3415 x1HC01.L=0.055; x1HC02.L=0.055; x1HC03.L=0.06;  
 3416 x1HC04.L=0.06; x1HC05.L=0.06; x1HC06.L=0.059;  
 3417 x1HC07.L=0.059; x1HC08.L=0.059; x1HC11.L=0.059;  
 3418 x1HC14.L=0.059; x1HC15.L=0.059; x1HC16.L=0.059;  
 3419 x1HC22.L=0.047; x1HC23.L=0.047; x1HC24.L=0.047;  
 3420 x1HC25.L=0.05; x1HC26.L=0.048; x1HC27.L=0.045;  
 3421 x1HC28.L=0.019; x1HC29.L=0.019; x1HC30.L=0.012;  
 \_Economic Optimization Program

3422 x1HC31.L=0.015; x1HC33.L=0.023; x1HC34.L=0.023;  
 3423 x1HC38.L=0.023; x1HC40.L=0.023; x1HC41.L=0.023;  
 3424 x1HC45.L=0.023; x1R1.L=0.019; x1R29.L=0.015;  
 3425 x1SC401.L=0.006; x1SC404.L=0.0000081; x1SC405.L=0.0000081;  
 3426 x1SC406.L=0.0000081; x1SC407.L=0.0000081; x1SC409.L=0.02;  
 3427 x1SC411.L=0.02; x1SC412.L=0.02; x1SC413.L=0.02;  
 3428 x1SC414.L=0.1; x2AC09.L=0; x2AC20.L=0;  
 3429 x2AC31.L=0; x2AC42.L=0; x2C301.L=0;  
 3430 x2C417.L=0.00031; x2C418.L=0.000922; x2C419.L=0.000922;  
 3431 x2HC01.L=0.1; x2HC02.L=0.1; x2HC03.L=0.000889;  
 3432 x2HC04.L=0.000889; x2HC05.L=0.000889; x2HC06.L=0.022;  
 3433 x2HC07.L=0.022; x2HC08.L=0.022; x2HC11.L=0.022;  
 3434 x2HC14.L=0.022; x2HC15.L=0.022; x2HC16.L=0.022;  
 3435 x2HC22.L=0; x2HC23.L=0; x2HC24.L=0;  
 3436 x2HC25.L=0; x2HC26.L=0; x2HC27.L=0;  
 3437 x2HC28.L=0; x2HC29.L=0; x2HC30.L=0;  
 3438 x2HC31.L=0; x2R1.L=0; x2R29.L=0;  
 3439 x2SC401.L=0.009; x2SC404.L=0.012; x2SC405.L=0.012;  
 3440 x2SC406.L=0.012; x2SC407.L=0.012; x2SC409.L=0.00031;  
 3441 x2SC411.L=0.00031; x2SC412.L=0.00031; x2SC413.L=0.00031;  
 3442 x2SC414.L=0.1; x3AC09.L=0.132; x3AC20.L=0.088;  
 3443 x3AC31.L=0.051; x3AC42.L=0.062; x3C301.L=0.781;  
 3444 x3C302.L=0.71; x3C303.L=0.774; x3C306.L=0.78;  
 3445 x3C307.L=0.78; x3C308.L=0.775; x3C309.L=0.775;  
 3446 x3C310.L=0.812; x3C311.L=0.762; x3C312.L=0.79;  
 3447 x3C315.L=0.79; x3C317.L=0.813; x3C318.L=0.813;  
 3448 x3C319.L=0.813; x3C320.L=0.813; x3C321.L=0.813;  
 3449 x3C322.L=0.813; x3C323.L=0.813; x3C324.L=0.813;  
 3450 x3C326.L=0.00000166; x3C328.L=0.00000166; x3C329.L=0.00000166;  
 3451 x3C401.L=0.51; x3C402.L=0.51; x3C403.L=0.51;  
 3452 x3C404.L=0.51; x3C405.L=0.00000694; x3C406.L=0.00000694;  
 3453 x3C407.L=0.00000694; x3C408.L=0.00000694; x3C409.L=0.00000694;  
 3454 x3C410.L=0.000406; x3C411.L=0.000406; x3C412.L=0.000834;  
 3455 x3C413.L=0.000834; x3C414.L=0.83; x3C415.L=0.83;  
 3456 x3C418.L=0.837; x3C419.L=0.837; x3C425.L=0.000406;  
 3457 x3C426.L=0.000406; x3C427.L=0.000533; x3C428.L=0.000586;  
 3458 x3C430.L=0.000634; x3C431.L=0.000834; x3C432.L=0.000834;  
 3459 x3HC01.L=0.01; x3HC02.L=0.01; x3HC03.L=0.836;  
 3460 x3HC04.L=0.836; x3HC05.L=0.836; x3HC06.L=0.656;  
 3461 x3HC07.L=0.656; x3HC08.L=0.656; x3HC11.L=0.656;  
 3462 x3HC14.L=0.656; x3HC15.L=0.656; x3HC16.L=0.656;



3463 x3HC22.L=0.677; x3HC23.L=0.677; x3HC24.L=0.677;  
3464 x3HC25.L=0.665; x3HC26.L=0.673; x3HC27.L=0.684;  
3465 x3HC28.L=0.568; x3HC29.L=0.568; x3HC30.L=0.446;  
3466 x3HC31.L=0.51; x3HC33.L=0.774; x3HC34.L=0.774;  
3467 x3HC38.L=0.774; x3HC40.L=0.774; x3HC41.L=0.774;  
\_Economic Optimization Program

05/15/01 16:49:39 PAGE 80  
GAMS 2.50A Windows NT/95/98

3468 x3HC45.L=0.774; x3R1.L=0.568; x3R29.L=0.516;  
3469 x3SC401.L=0.293; x3SC404.L=0.021; x3SC405.L=0.021;  
3470 x3SC406.L=0.021; x3SC407.L=0.021; x3SC409.L=0.967;  
3471 x3SC411.L=0.967; x3SC412.L=0.967; x3SC413.L=0.967;  
3472 x3SC414.L=0.5; x4AC09.L=0.02; x4AC20.L=0.014;  
3473 x4AC31.L=0.008; x4AC42.L=0.01; x4C301.L=0.105;  
3474 x4C302.L=0.073; x4C303.L=0.101; x4C306.L=0.099;  
3475 x4C307.L=0.099; x4C308.L=0.108; x4C309.L=0.108;  
3476 x4C310.L=0.084; x4C311.L=0.117; x4C312.L=0.08;  
3477 x4C315.L=0.08; x4C317.L=0.082; x4C318.L=0.082;  
3478 x4C319.L=0.082; x4C320.L=0.082; x4C321.L=0.082;  
3479 x4C322.L=0.082; x4C323.L=0.082; x4C324.L=0.082;  
3480 x4C325.L=0; x4C326.L=0; x4C328.L=0;  
3481 x4C329.L=0; x4C401.L=0.104; x4C402.L=0.104;  
3482 x4C403.L=0.104; x4C404.L=0.104; x4C405.L=0.059;  
3483 x4C406.L=0.059; x4C407.L=0.059; x4C408.L=0.059;  
3484 x4C409.L=0.059; x4C410.L=0.527; x4C411.L=0.527;  
3485 x4C412.L=0.826; x4C413.L=0.826; x4C414.L=0.095;  
3486 x4C415.L=0.095; x4C418.L=0.092; x4C419.L=0.092;  
3487 x4C425.L=0.527; x4C426.L=0.527; x4C427.L=0.676;  
3488 x4C428.L=0.738; x4C430.L=0.641; x4C431.L=0.826;  
3489 x4C432.L=0.826; x4HC01.L=0.085; x4HC02.L=0.085;  
3490 x4HC03.L=0.091; x4HC04.L=0.091; x4HC05.L=0.091;  
3491 x4HC06.L=0.09; x4HC07.L=0.09; x4HC08.L=0.09;  
3492 x4HC11.L=0.09; x4HC14.L=0.09; x4HC15.L=0.09;  
3493 x4HC16.L=0.09; x4HC22.L=0.105; x4HC23.L=0.105;  
3494 x4HC24.L=0.105; x4HC25.L=0.102; x4HC26.L=0.104;  
3495 x4HC27.L=0.106; x4HC28.L=0.109; x4HC29.L=0.109;  
3496 x4HC30.L=0.096; x4HC31.L=0.104; x4HC33.L=0.127;  
3497 x4HC34.L=0.127; x4HC38.L=0.127; x4HC40.L=0.127;  
3498 x4HC41.L=0.127; x4HC45.L=0.127; x4R1.L=0.109;  
3499 x4R29.L=0.105; x4SC401.L=0.562; x4SC404.L=0.784;  
3500 x4SC405.L=0.784; x4SC406.L=0.784; x4SC407.L=0.784;  
3501 x4SC409.L=0.013; x4SC411.L=0.013; x4SC412.L=0.013;  
3502 x4SC413.L=0.013; x4SC414.L=0.1; x5AC09.L=0.006;  
3503 x5AC20.L=0.004; x5AC31.L=0.002; x5AC42.L=0.003;  
3504 x5C301.L=0.019; x5C302.L=0.005; x5C303.L=0.017;  
3505 x5C306.L=0.015; x5C307.L=0.015; x5C308.L=0.021;  
3506 x5C309.L=0.021; x5C310.L=0.006; x5C311.L=0.026;  
3507 x5C312.L=0.006; x5C315.L=0.006; x5C317.L=0.006;  
3508 x5C318.L=0.006; x5C319.L=0.006; x5C320.L=0.006;  
3509 x5C321.L=0.006; x5C322.L=0.006; x5C323.L=0.006;  
3510 x5C324.L=0.006; x5C325.L=0; x5C326.L=0;  
3511 x5C328.L=0; x5C329.L=0; x5C401.L=0.054;  
3512 x5C402.L=0.054; x5C403.L=0.054; x5C404.L=0.054;  
3513 x5C405.L=0.14; x5C406.L=0.14; x5C407.L=0.14;  
\_Economic Optimization Program

05/15/01 16:49:39 PAGE 81  
GAMS 2.50A Windows NT/95/98

3514 x5C408.L=0.14; x5C409.L=0.14; x5C410.L=0.099;  
3515 x5C411.L=0.099; x5C412.L=0.072; x5C413.L=0.072;  
3516 x5C414.L=0.001; x5C415.L=0.001; x5C418.L=0.001;  
3517 x5C419.L=0.001; x5C425.L=0.099; x5C426.L=0.099;  
3518 x5C427.L=0.086; x5C428.L=0.08; x5C430.L=0.088;  
3519 x5C431.L=0.072; x5C432.L=0.072; x5HC01.L=0.15;  
3520 x5HC02.L=0.15; x5HC03.L=0.001; x5HC04.L=0.001;  
3521 x5HC05.L=0.001; x5HC06.L=0.034; x5HC07.L=0.034;  
3522 x5HC08.L=0.034; x5HC11.L=0.034; x5HC14.L=0.034;  
3523 x5HC15.L=0.034; x5HC16.L=0.034; x5HC22.L=0.033;  
3524 x5HC23.L=0.033; x5HC24.L=0.033; x5HC25.L=0.033;  
3525 x5HC26.L=0.033; x5HC27.L=0.032; x5HC28.L=0.049;  
3526 x5HC29.L=0.049; x5HC30.L=0.058; x5HC31.L=0.054;  
3527 x5HC33.L=0.03; x5HC34.L=0.03; x5HC38.L=0.03;  
3528 x5HC40.L=0.03; x5HC41.L=0.03; x5HC45.L=0.03;  
3529 x5R1.L=0.049; x5R29.L=0.054; x5SC401.L=0.052;  
3530 x5SC404.L=0.073; x5SC405.L=0.073; x5SC406.L=0.073;  
3531 x5SC407.L=0.073; x5SC409.L=0; x5SC411.L=0;  
3532 x5SC412.L=0; x5SC413.L=0; x5SC414.L=0;  
3533 x6SC401.L=0.071; x6SC404.L=0.1; x6SC405.L=0.1;  
3534 x6SC406.L=0.1; x6SC407.L=0.1; x6SC409.L=0;  
3535 x6SC411.L=0; x6SC412.L=0; x6SC413.L=0;  
3536 x6SC414.L=0.1; x7AC09.L=0.02; x7AC20.L=0.015;  
3537 x7AC31.L=0.008; x7AC42.L=0.01; x7C301.L=0.027;  
3538 x7C302.L=0.144; x7C303.L=0.039; x7C306.L=0.033;  
3539 x7C307.L=0.033; x7C308.L=0.048; x7C309.L=0.048;  
3540 x7C310.L=0.005; x7C311.L=0.064; x7C312.L=0.005;  
3541 x7C315.L=0.005; x7C316.L=0.005; x7C317.L=0.005;  
3542 x7C318.L=0.005; x7C319.L=0.005; x7C320.L=0.005;  
3543 x7C321.L=0.005; x7C322.L=0.005; x7C323.L=0.005;  
3544 x7C324.L=0.005; x7C325.L=0; x7C326.L=0;  
3545 x7C328.L=0; x7C329.L=0; x7C401.L=0.316;  
3546 x7C402.L=0.316; x7C403.L=0.316; x7C404.L=0.316;

3547 x7C405.L=0.801; x7C406.L=0.801; x7C407.L=0.801;  
3548 x7C408.L=0.801; x7C409.L=0.801; x7C410.L=0.374;  
3549 x7C411.L=0.374; x7C412.L=0.101; x7C413.L=0.101;  
3550 x7C414.L=0.012; x7C415.L=0.012; x7C417.L=0.00031;  
3551 x7C418.L=0.011; x7C419.L=0.011; x7C425.L=0.374;  
3552 x7C426.L=0.374; x7C427.L=0.238; x7C428.L=0.181;  
3553 x7C430.L=0.271; x7C431.L=0.101; x7C432.L=0.101;  
3554 x7HC01.L=0.6; x7HC02.L=0.6; x7HC03.L=0.01;  
3555 x7HC04.L=0.01; x7HC05.L=0.01; x7HC06.L=0.139;  
3556 x7HC07.L=0.139; x7HC08.L=0.139; x7HC11.L=0.139;  
3557 x7HC14.L=0.139; x7HC15.L=0.139; x7HC16.L=0.139;  
3558 x7HC22.L=0.138; x7HC23.L=0.139; x7HC24.L=0.139;  
3559 x7HC25.L=0.15; x7HC26.L=0.142; x7HC27.L=0.131;  
\_Economic Optimization Program

05/15/01 16:49:39 PAGE 82  
GAMS 2.50A Windows NT/95/98

3560 x7HC28.L=0.255; x7HC29.L=0.255; x7HC30.L=0.389;  
3561 x7HC31.L=0.316; x7HC33.L=0.046; x7HC34.L=0.046;  
3562 x7HC38.L=0.046; x7HC40.L=0.046; x7HC41.L=0.046;  
3563 x7HC45.L=0.046; x7R1.L=0.255; x7R29.L=0.31;  
3564 x7SC401.L=0.007; x7SC404.L=0.01; x7SC405.L=0.01;  
3565 x7SC406.L=0.01; x7SC407.L=0.01; x7SC409.L=0;  
3566 x7SC411.L=0; x7SC412.L=0; x7SC413.L=0;  
3567 x7SC414.L=0.1; x8AC09.L=0.00000448; x8AC20.L=0.00000554;  
3568 x8AC31.L=0.00000475; x8AC42.L=0.00000478; x9AC09.L=0.005;  
3569 x9AC20.L=0.005; x9AC31.L=0.002; x9AC42.L=0.003;  
3570 xAC02.L=0.5; xAC05.L=0.498; xAC07.L=0.498;  
3571 xAC09.L=0.482; xAC12.L=0.498; xAC15.L=0.496;  
3572 xAC18.L=0.496; xAC20.L=0.485; xAC23.L=0.496;  
3573 xAC26.L=0.494; xAC29.L=0.494; xAC31.L=0.488;  
3574 xAC34.L=0.494; xAC37.L=0.492; xAC40.L=0.492;  
3575 xAC42.L=0.484; xiC10AC09.L=0; xiC10AC20.L=0;  
3576 xiC10AC31.L=0; xiC10AC42.L=0; xiC11AC09.L=0;  
3577 xiC11AC20.L=0; xiC11AC31.L=0; xiC11AC42.L=0;  
3578 xM1C606D.L=0.0000485; xM3C606D.L=0.000334; xM4C606D.L=0.55;  
3579 xM5C606D.L=0.104; xM7C606D.L=0.346; xx1C302.L=0.093;  
3580 xx1C308.L=0.063; xx1C310.L=0.12; xx1C311.L=0.042;  
3581 xx1C312.L=0.151; xx1C323.L=0.12; xx1C325.L=1;  
3582 xx1C405.L=0; xx1C408.L=0; xx1C425.L=0.000153;  
3583 xx1C428.L=0.000207; xx1C430.L=0.0000689; xx1C431.L=0.00064;  
3584 xx1HC28.L=0.027; xx1HC29.L=0.027; xx1HC30.L=0.018;  
3585 xx1HC32.L=0.031; xx1R1.L=0.027; xx1R29.L=0.023;  
3586 xx1SC406.L=0.0000111; xx1SC408.L=0.026; xx2HC28.L=0;  
3587 xx2HC29.L=0; xx2HC30.L=0; xx2R1.L=0;  
3588 xx2R29.L=0; xx2SC406.L=0.013; xx2SC408.L=0.000319;  
3589 xx3C302.L=0.729; xx3C308.L=0.779; xx3C310.L=0.791;  
3590 xx3C311.L=0.774; xx3C312.L=0.764; xx3C323.L=0.792;  
3591 xx3C325.L=0.00000126; xx3C405.L=0.00000975; xx3C408.L=0.00000975;  
3592 xx3C425.L=0.000473; xx3C428.L=0.000633; xx3C430.L=0.000709;  
3593 xx3C431.L=0.000875; xx3C432.L=0.000875; xx3HC28.L=0.621;  
3594 xx3HC29.L=0.621; xx3HC30.L=0.515; xx3HC32.L=0.784;  
3595 xx3R1.L=0.621; xx3R29.L=0.578; xx3SC406.L=0.021;  
3596 xx3SC408.L=0.961; xx4C302.L=0.075; xx4C308.L=0.109;  
3597 xx4C310.L=0.082; xx4C311.L=0.119; xx4C312.L=0.077;  
3598 xx4C323.L=0.08; xx4C325.L=0; xx4C405.L=0.083;  
3599 xx4C408.L=0.083; xx4C409.L=0.083; xx4C425.L=0.613;  
3600 xx4C427.L=0.746; xx4C428.L=0.797; xx4C430.L=0.716;  
3601 xx4C431.L=0.867; xx4C432.L=0.867; xx4HC28.L=0.12;  
3602 xx4HC29.L=0.12; xx4HC30.L=0.11; xx4HC32.L=0.129;  
3603 xx4R1.L=0.12; xx4R29.L=0.117; xx4SC406.L=0.814;  
3604 xx4SC408.L=0.012; xx5C302.L=0.004; xx5C308.L=0.017;  
3605 xx5C310.L=0.005; xx5C311.L=0.021; xx5C312.L=0.005;  
\_Economic Optimization Program

05/15/01 16:49:39 PAGE 83  
GAMS 2.50A Windows NT/95/98

3606 xx5C323.L=0.005; xx5C325.L=0; xx5C405.L=0.158;  
3607 xx5C408.L=0.158; xx5C425.L=0.093; xx5C428.L=0.07;  
3608 xx5C430.L=0.079; xx5C431.L=0.061; xx5HC28.L=0.044;  
3609 xx5HC29.L=0.044; xx5HC30.L=0.054; xx5HC32.L=0.025;  
3610 xx5R1.L=0.044; xx5R29.L=0.049; xx5SC406.L=0.061;  
3611 xx5SC408.L=0; xx6SC406.L=0.084; xx6SC408.L=0;  
3612 xx7C302.L=0.1; xx7C308.L=0.033; xx7C310.L=0.003;  
3613 xx7C311.L=0.044; xx7C312.L=0.003; xx7C323.L=0.004;  
3614 xx7C325.L=0; xx7C405.L=0.759; xx7C408.L=0.759;  
3615 xx7C425.L=0.293; xx7C428.L=0.132; xx7C430.L=0.204;  
3616 xx7C431.L=0.071; xx7HC28.L=0.188; xx7HC29.L=0.188;  
3617 xx7HC30.L=0.303; xx7HC32.L=0.031; xx7R1.L=0.188;  
3618 xx7R29.L=0.234; xx7SC406.L=0.007; xx7SC408.L=0;  
3619 y1HC28.L=0.077; y1HC29.L=0.077; y1HC30.L=0.062;  
3620 y1HC31.L=0.068; y1R1.L=0.077; y1R29.L=0.069;  
3621 y2HC28.L=0; y2HC29.L=0; y2HC30.L=0;  
3622 y2HC31.L=0; y2R1.L=0; y2R29.L=0;  
3623 y3HC28.L=0.789; y3HC29.L=0.789; y3HC30.L=0.771;  
3624 y3HC31.L=0.781; y3R1.L=0.789; y3R29.L=0.783;  
3625 y4HC28.L=0.1; y4HC29.L=0.1; y4HC30.L=0.108;  
3626 y4HC31.L=0.105; y4R1.L=0.1; y4R29.L=0.104;  
3627 y5HC28.L=0.015; y5HC29.L=0.015; y5HC30.L=0.022;  
3628 y5HC31.L=0.019; y5R1.L=0.015; y5R29.L=0.018;  
3629 y7HC28.L=0.019; y7HC29.L=0.019; y7HC30.L=0.037;  
3630 y7HC31.L=0.027; y7R1.L=0.019; y7R29.L=0.026;

3631 yy1HC28.L=0.1; yy1HC29.L=0.1; yy1HC30.L=0.081;  
3632 yy1R1.L=0.1; yy1R29.L=0.09; yy2HC28.L=0;  
3633 yy2HC29.L=0; yy2HC30.L=0; yy2R1.L=0;  
3634 yy2R29.L=0; yy3HC28.L=0.777; yy3HC29.L=0.777;  
3635 yy3HC30.L=0.768; yy3R1.L=0.777; yy3R29.L=0.775;  
3636 yy4HC28.L=0.098; yy4HC29.L=0.098; yy4HC30.L=0.108;  
3637 yy4R1.L=0.098; yy4R29.L=0.103; yy5HC28.L=0.012;  
3638 yy5HC29.L=0.012; yy5HC30.L=0.018; yy5R1.L=0.012;  
3639 yy5R29.L=0.015; yy7HC28.L=0.013; yy7HC29.L=0.013;  
3640 yy7HC30.L=0.025; yy7R1.L=0.013; yy7R29.L=0.017;  
3641 C10pC623.LO=0; C10pC625.LO=0; C10pC627.LO=0;  
3642 C10pC629.LO=0; C2C623.LO=0; C2C625.LO=0;  
3643 C2C627.LO=0; C2C629.LO=0; C3C623.LO=0;  
3644 C3C625.LO=0; C3C627.LO=0; C3C629.LO=0;  
3645 C3pC623.LO=0; C3pC625.LO=0; C3pC627.LO=0;  
3646 C3pC629.LO=0; C4pC623.LO=0; C4pC625.LO=0;  
3647 C4pC627.LO=0; C4pC629.LO=0; C5pC623.LO=0;  
3648 C5pC625.LO=0; C5pC627.LO=0; C5pC629.LO=0;  
3649 C7pC623.LO=0; C7pC625.LO=0; C7pC627.LO=0;  
3650 C7pC629.LO=0; C8pC623.LO=0; C8pC625.LO=0;  
3651 C8pC627.LO=0; C8pC629.LO=0; C9pC623.LO=0;  
\_Economic Optimization Program

05/15/01 16:49:39 PAGE 84  
GAMS 2.50A Windows NT/95/98

3652 C9pC625.LO=0; C9pC627.LO=0; C9pC629.LO=0;  
3653 CHXC623.LO=2.5; CHXC625.LO=2.5; CHXC627.LO=2.5;  
3654 CHXC629.LO=2.5; CiC10pC623.LO=0; CiC10pC625.LO=0;  
3655 CiC10pC627.LO=0; CiC10pC629.LO=0; CiC11pC623.LO=0;  
3656 CiC11pC625.LO=0; CiC11pC627.LO=0; CiC11pC629.LO=0;  
3657 CiC4eC623.LO=0; CiC4eC625.LO=0; CiC4eC627.LO=0;  
3658 CiC4eC629.LO=0; CiC5eC623.LO=0; CiC5eC625.LO=0;  
3659 CiC5eC627.LO=0; CiC5eC629.LO=0; CiC8eC623.LO=0;  
3660 CiC8eC625.LO=0; CiC8eC627.LO=0; CiC8eC629.LO=0;  
3661 Cost.LO=-10000; dTE601.LO=5; dTE602.LO=5;  
3662 dTE603.LO=5; dTE605.LO=5; dTE609A.LO=5;  
3663 dTE610.LO=5; dTE611.LO=5; dTE612.LO=10;  
3664 dTE613.LO=4; dTE616.LO=10; dTE617.LO=5;  
3665 dTE621A.LO=5; dTE621B.LO=5; dTE626.LO=5;  
3666 dTE627A.LO=5; dTE627B.LO=5; dTE628.LO=5;  
3667 dTE629.LO=5; dTE633.LO=5; dTE634.LO=5;  
3668 dTE640.LO=5; dTE641.LO=5; dTE695A.LO=5;  
3669 dTE695B.LO=5; dTE696A.LO=10; dTE696B.LO=10;  
3670 dTE6XX.LO=1; Earnings.LO=-10000; f1C601.LO=0;  
3671 f1C603.LO=0; f1C606A.LO=0; f2C601.LO=0.5;  
3672 f3C601.LO=0.05; f3C603.LO=0; f3C606A.LO=0;  
3673 f4C601.LO=0.95; f4C603.LO=0; f4C606A.LO=0;  
3674 f5C601.LO=0.5; f5C603.LO=0.5; f5C606A.LO=0.5;  
3675 f6C601.LO=0.5; f7C601.LO=0.5; f7C603.LO=0.5;  
3676 f7C606A.LO=0.5; FAC05.LO=0.1; FAC07.LO=0.1;  
3677 FAC09.LO=0.01; FAC15.LO=0.1; FAC18.LO=0.1;  
3678 FAC20.LO=0.01; FAC26.LO=0.1; FAC29.LO=0.1;  
3679 FAC31.LO=0.01; FAC37.LO=0.1; FAC40.LO=0.1;  
3680 FAC42.LO=0.01; FC301.LO=1; FC302.LO=0.1;  
3681 FC303.LO=2; FC306.LO=0.1; FC307.LO=0.0001;  
3682 FC309.LO=0.0001; FC310.LO=0.0001; FC311.LO=0;  
3683 FC312.LO=0.0001; FC315.LO=0.0001; FC317.LO=0.1;  
3684 FC318.LO=0.0001; FC319.LO=0.0001; FC321.LO=0;  
3685 FC323.LO=0.5; FC324.LO=0.5; FC325.LO=0.5;  
3686 FC326.LO=0.01; FC401.LO=0.1; FC402.LO=0.1;  
3687 FC404.LO=0; FC405.LO=0.1; FC406.LO=0;  
3688 FC408.LO=0; FC409.LO=0; FC410.LO=0.1;  
3689 FC411.LO=0; FC413.LO=0; FC414.LO=0.1;  
3690 FC415.LO=0; FC418.LO=0.1; FC419.LO=0.0001;  
3691 FC425.LO=1; FC426.LO=0; FC427.LO=0;  
3692 FC428.LO=0; FC430.LO=1; FC431.LO=0;  
3693 FC432.LO=1; FcwE603.LO=0.1; FcwE605.LO=0.1;  
3694 FcwE609A.LO=0.01; FcwE611.LO=0.1; FcwE613.LO=0.1;  
3695 FcwE617.LO=1; FcwE621A.LO=0.1; FcwE621B.LO=0.1;  
3696 FcwE626.LO=0.1; FcwE627A.LO=0.1; FcwE627B.LO=0.1;  
3697 FcwE634.LO=4; FcwE640.LO=0.4; FcwE641A.LO=0.1;  
\_Economic Optimization Program

05/15/01 16:49:39 PAGE 85  
GAMS 2.50A Windows NT/95/98

3698 FcwE641B.LO=0.1; FHC02.LO=0.01; FHC03.LO=1;  
3699 FHC04.LO=1; FHC05.LO=1; FHC06.LO=1;  
3700 FHC07.LO=1; FHC08.LO=1; FHC11.LO=1;  
3701 FHC14.LO=1; FHC15.LO=1; FHC16.LO=1;  
3702 FHC22.LO=1; FHC23.LO=1; FHC24.LO=1;  
3703 FHC25.LO=1; FHC26.LO=1; FHC27.LO=1;  
3704 FHC28.LO=1; FHC29.LO=0; FHC30.LO=0;  
3705 FHC31.LO=0; FHC33.LO=0; FHC34.LO=0;  
3706 FHC38.LO=0; FHC40.LO=0; FHC41.LO=0;  
3707 FHC45.LO=0; FIHC28.LO=1; FIHC29.LO=0;  
3708 FIHC30.LO=0; FIHC31.LO=0; FIR1.LO=0;  
3709 FIR29.LO=0; FmC302.LO=0; FmC308.LO=0.0001;  
3710 FmC310.LO=0; FmC311.LO=0; FmC312.LO=0;  
3711 FmC317.LO=0.001; FmC322.LO=0; FmC323.LO=0;  
3712 FmC325.LO=0.01; FmC405.LO=0; FmC407.LO=0;  
3713 FmC408.LO=0; FmC409.LO=0; FmC412.LO=0;  
3714 FmC414.LO=0.0001; FmC425.LO=0; FmC427.LO=0;

3715 FmC428.LO=0; FmC430.LO=0; FmC431.LO=0;  
 3716 FmC432.LO=0; FmHC01.LO=0; FmHC32.LO=0;  
 3717 FmIHC28.LO=0.01; FmIHC29.LO=0; FmIHC30.LO=0;  
 3718 FmIR1.LO=0; FmIR29.LO=0; FmSC403.LO=0.001;  
 3719 FmSC406.LO=0; FmSC408.LO=0; FmvHC28.LO=0;  
 3720 FmvHC29.LO=0; FmvHC30.LO=0; FmvR1.LO=0;  
 3721 FmvR29.LO=0; FR1.LO=0; FR29.LO=0;  
 3722 FSC401.LO=0.1; FSC403.LO=0.1; FSC404.LO=0.1;  
 3723 FSC406.LO=0; FSC407.LO=0; FSC408.LO=0.05;  
 3724 FSC409.LO=0.05; FSC412.LO=0.102; FSC414.LO=0;  
 3725 FstmE602.LO=0.1; FstmE695A.LO=0; FstmE695B.LO=0.1;  
 3726 FstmE696A.LO=0.01; FstmE696B.LO=0.01; FvHC28.LO=0;  
 3727 FvHC29.LO=0; FvHC30.LO=0; FvHC31.LO=0;  
 3728 FvR1.LO=0; FvR29.LO=0; h1C601.LO=0.8;  
 3729 h1C603.LO=-3; h1C606A.LO=0; h2C601.LO=0.395;  
 3730 h3C601.LO=0.5; h3C603.LO=0; h3C606A.LO=-65;  
 3731 h4C601.LO=0.45; h4C603.LO=0; h4C606A.LO=-10;  
 3732 h5C601.LO=0.5; h5C603.LO=0; h5C606A.LO=-5;  
 3733 h6C601.LO=0.5; h7C601.LO=0.5; h7C603.LO=0;  
 3734 h7C606A.LO=0; hAC02.LO=0; hAC05.LO=10;  
 3735 hAC07.LO=10; hAC09.LO=10; hAC12.LO=0;  
 3736 hAC15.LO=10; hAC18.LO=10; hAC20.LO=10;  
 3737 hAC23.LO=0; hAC26.LO=10; hAC29.LO=10;  
 3738 hAC31.LO=10; hAC34.LO=0; hAC37.LO=10;  
 3739 hAC40.LO=10; hAC42.LO=10; hacAC09.LO=10;  
 3740 hacAC20.LO=10; hacAC31.LO=10; hacAC42.LO=10;  
 3741 hC301.LO=10; hC302.LO=0; hC303.LO=0.0001;  
 3742 hC306.LO=0.0001; hC307.LO=0.0001; hC308.LO=0.0001;  
 3743 hC309.LO=0.0001; hC310.LO=0.0001; hC311.LO=0.0001;  
 \_Economic Optimization Program

05/15/01 16:49:39 PAGE 86  
GAMS 2.50A Windows NT/95/98

3744 hC312.LO=0.0001; hC312liq.LO=0; hC315.LO=0.0001;  
 3745 hC316.LO=0.0001; hC317.LO=0.0001; hC318.LO=0.0001;  
 3746 hC319.LO=0.0001; hC321.LO=0; hC322.LO=0.0001;  
 3747 hC323.LO=0; hC324.LO=0.0001; hC325.LO=0.0001;  
 3748 hC326.LO=0.0001; hC329.LO=0.0001; hC401.LO=0;  
 3749 hC402.LO=10; hC403.LO=0.0001; hC404.LO=0.0001;  
 3750 hC405.LO=0.0001; hC406.LO=0.0001; hC407.LO=0.0001;  
 3751 hC408.LO=0.0001; hC408vap.LO=10; hC409.LO=0.0001;  
 3752 hC410.LO=0.0001; hC410vap.LO=10; hC411.LO=10;  
 3753 hC412.LO=0.0001; hC412liq.LO=1; hC413.LO=0.0001;  
 3754 hC414.LO=0.0001; hC414liq.LO=10; hC415.LO=0.0001;  
 3755 hC417.LO=0.0001; hC418.LO=0.0001; hC419.LO=0.0001;  
 3756 hC425.LO=10; hC426.LO=10; hC427.LO=0;  
 3757 hC428.LO=10; hC430.LO=10; hC431.LO=10;  
 3758 hC432.LO=10; hC623.LO=10; hC625.LO=10;  
 3759 hC627.LO=10; hC629.LO=10; hHC01.LO=0;  
 3760 hHC02.LO=0; hHC03.LO=1; hHC04.LO=10;  
 3761 hHC05.LO=10; hHC06.LO=10; hHC07.LO=10;  
 3762 hHC11.LO=10; hHC14.LO=10; hHC16.LO=10;  
 3763 hHC29.LO=20; hHC30.LO=20; hHC31.LO=100;  
 3764 hHC32.LO=0; hHC34.LO=0; hHC38.LO=0;  
 3765 hHC41.LO=0; hHC45.LO=0; hHC29.LO=0;  
 3766 hHC30.LO=0; hHC31.LO=20; hIR1.LO=0;  
 3767 hIR29.LO=10; hR1.LO=0; hR29.LO=20;  
 3768 hSC401.LO=10; hSC402.LO=10; hSC403.LO=10;  
 3769 hSC404.LO=10; hSC405.LO=10; hSC406.LO=0.1;  
 3770 hSC407.LO=10; hSC408.LO=10; hSC409.LO=10;  
 3771 hSC411.LO=10; hSC412.LO=10; hSC413.LO=10;  
 3772 hSC414.LO=0; hvHC29.LO=10; hvHC30.LO=10;  
 3773 hvHC31.LO=20; hvR1.LO=0; hvR29.LO=10;  
 3774 K1C323.LO=1; K1C325.LO=0.5; K1C408.LO=1;  
 3775 K1C414.LO=1; K1C428.LO=0; K1C430.LO=1;  
 3776 K1C601.LO=1.5; K1C603.LO=1; K1C606A.LO=1;  
 3777 K1C606C.LO=1; K1C614B.LO=2; K1C615\_A.LO=0.5;  
 3778 K1C616\_A.LO=0.5; K1E633.LO=1; K1E6XX.LO=1;  
 3779 K1SC406.LO=2; K1SC408.LO=1.5; K2C601.LO=0.5;  
 3780 K2E633.LO=0.2; K2E6XX.LO=0.2; K2SC406.LO=0.5;  
 3781 K2SC408.LO=0.5; K3C323.LO=0.5; K3C325.LO=0.01;  
 3782 K3C408.LO=1; K3C414.LO=0.5; K3C428.LO=0;  
 3783 K3C430.LO=1; K3C601.LO=0.5; K3C603.LO=0.5;  
 3784 K3C606A.LO=0.5; K3C606C.LO=1; K3C614B.LO=0.6;  
 3785 K3C615\_A.LO=0.1; K3C616\_A.LO=0.1; K3E633.LO=0.3;  
 3786 K3E6XX.LO=0.3; K3SC406.LO=1; K3SC408.LO=0.7;  
 3787 K4C323.LO=0.5; K4C325.LO=0.03; K4C408.LO=1;  
 3788 K4C414.LO=0.5; K4C428.LO=0; K4C430.LO=0.5;  
 3789 K4C601.LO=0.2; K4C603.LO=0.1; K4C606A.LO=0.1;  
 \_Economic Optimization Program

05/15/01 16:49:39 PAGE 87  
GAMS 2.50A Windows NT/95/98

3790 K4C606C.LO=1; K4C614B.LO=0.5; K4C615\_A.LO=0.05;  
 3791 K4C616\_A.LO=0.05; K4E633.LO=0.2; K4E6XX.LO=0.2;  
 3792 K4SC406.LO=0.8; K4SC408.LO=0.5; K5C323.LO=0.1;  
 3793 K5C325.LO=0.1; K5C408.LO=0.5; K5C414.LO=0.1;  
 3794 K5C428.LO=0; K5C430.LO=0.2; K5C601.LO=0.1;  
 3795 K5C603.LO=0.01; K5C606A.LO=0.1; K5C606C.LO=0.1;  
 3796 K5C614B.LO=0.05; K5C615\_A.LO=0.002; K5C616\_A.LO=0.002;  
 3797 K5E633.LO=0.05; K5E6XX.LO=0.05; K5SC406.LO=0.1;  
 3798 K5SC408.LO=0.2; K6C601.LO=0.1; K6SC406.LO=0;

3799 K6SC408.LO=0.1; K7C323.LO=0.1; K7C325.LO=0.001;  
 3800 K7C408.LO=0.1; K7C414.LO=0.05; K7C428.LO=0;  
 3801 K7C430.LO=0; K7C601.LO=0.01; K7C603.LO=0.01;  
 3802 K7C606A.LO=0.05; K7C614B.LO=0.001; K7C615\_A.LO=0.001;  
 3803 K7C616\_A.LO=0.011; K7E633.LO=0.01; K7E6XX.LO=0.01;  
 3804 K7SC406.LO=0.1; K7SC408.LO=0.05; Kp1C601.LO=1;  
 3805 Kp1C603.LO=1; Kp1C606A.LO=1; Kp1C606D.LO=1;  
 3806 Kp2C601.LO=0.5; Kp3C601.LO=1; Kp3C603.LO=0.5;  
 3807 Kp3C606A.LO=0.5; Kp3C606D.LO=1; Kp4C601.LO=0.5;  
 3808 Kp4C603.LO=0.2; Kp4C606A.LO=0.1; Kp4C606D.LO=1;  
 3809 Kp5C601.LO=0.1; Kp5C603.LO=0.1; Kp5C606A.LO=0.1;  
 3810 Kp5C606D.LO=1; Kp6C601.LO=0.1; Kp7C601.LO=0.01;  
 3811 Kp7C603.LO=0.01; Kp7C606A.LO=0.05; Kp7C606D.LO=0.1;  
 3812 kWad1.LO=50; kWad2.LO=105; LpC601.LO=1;  
 3813 LpC603.LO=1; LpC606A.LO=0.5; PC303.LO=101;  
 3814 PC306.LO=650; PC307.LO=600; PC308.LO=600;  
 3815 PC309.LO=580; PC311.LO=260; PC312.LO=600;  
 3816 PHC30.LO=101; PHC32.LO=101; PR29.LO=101;  
 3817 Profit.LO=10; Q2HC07.LO=0; Q2HC11.LO=0;  
 3818 Q2HC14.LO=0; Q2HC16.LO=0; qFp1C606A.LO=0;  
 3819 qFp3C606A.LO=0; qFp4C606A.LO=0; qFp5C606A.LO=0;  
 3820 qFp7C606A.LO=0; qS1C606A.LO=0; qS3C606A.LO=0;  
 3821 qS4C606A.LO=0; qS5C606A.LO=0; qS7C606A.LO=0;  
 3822 r10C623.LO=0; r10C625.LO=0; r10C627.LO=0;  
 3823 r10C629.LO=0; r2C623.LO=0; r2C625.LO=0;  
 3824 r2C627.LO=0; r2C629.LO=0; r3C623.LO=0;  
 3825 r3C625.LO=0; r3C627.LO=0; r3C629.LO=0;  
 3826 r4C623.LO=0; r4C625.LO=0; r4C627.LO=0;  
 3827 r4C629.LO=0; r5C623.LO=0; r5C625.LO=0;  
 3828 r5C627.LO=0; r5C629.LO=0; r7C623.LO=0;  
 3829 r7C625.LO=0; r7C627.LO=0; r7C629.LO=0;  
 3830 r8C623.LO=0; r8C625.LO=0; r8C627.LO=0;  
 3831 r8C629.LO=0; r9C623.LO=0; r9C625.LO=0;  
 3832 r9C627.LO=0; r9C629.LO=0; rho2HC07.LO=610;  
 3833 rho2HC11.LO=610; rho2HC14.LO=610; rho2HC16.LO=610;  
 3834 rhoAC09.LO=1500; rhoAC20.LO=1500; rhoAC31.LO=1500;  
 3835 rhoAC42.LO=1500; riC10C623.LO=0; riC10C625.LO=0;  
 \_Economic Optimization Program

05/15/01 16:49:39 PAGE 88  
GAMS 2.50A Windows NT/95/98

3836 riC10C627.LO=0; riC10C629.LO=0; riC11C623.LO=0;  
 3837 riC11C625.LO=0; riC11C627.LO=0; riC11C629.LO=0;  
 3838 sf1S34.LO=0.0001; sf2S34.LO=0; sfS11.LO=0.1;  
 3839 sfS19.LO=0.1; sfS2.LO=0.1; sfS23.LO=0.1;  
 3840 sfS27.LO=0.1; sfS41.LO=0.0001; sfS42.LO=0.0001;  
 3841 sfS5.LO=0.1; sfS7.LO=0.1; Sm1C601.LO=1;  
 3842 Sm1C603.LO=0.05; Sm1C606A.LO=0.1; Sm1C606D.LO=1;  
 3843 Sm2C601.LO=0.5; Sm3C601.LO=0.5; Sm3C603.LO=0.001;  
 3844 Sm3C606A.LO=0.1; Sm3C606D.LO=1; Sm4C601.LO=0.4;  
 3845 Sm4C603.LO=0.01; Sm4C606A.LO=0.1; Sm4C606D.LO=0.5;  
 3846 Sm5C601.LO=0.1; Sm5C603.LO=0.01; Sm5C606A.LO=0.05;  
 3847 Sm5C606D.LO=0.1; Sm6C601.LO=0.1; Sm7C601.LO=0.01;  
 3848 Sm7C603.LO=0.001; Sm7C606A.LO=0.001; Sm7C606D.LO=0.1;  
 3849 Sn1C601.LO=1; Sn1C603.LO=1; Sn1C606A.LO=1;  
 3850 Sn2C601.LO=0.5; Sn3C601.LO=0.5; Sn3C603.LO=0.5;  
 3851 Sn3C606A.LO=1; Sn4C601.LO=0.5; Sn4C603.LO=0.2;  
 3852 Sn4C606A.LO=0.8; Sn5C601.LO=0.1; Sn5C603.LO=0.1;  
 3853 Sn5C606A.LO=0.3; Sn6C601.LO=0.1; Sn7C601.LO=0.01;  
 3854 Sn7C603.LO=0.01; Sn7C606A.LO=0.1; TAC02.LO=276;  
 3855 TAC05.LO=273; TAC07.LO=273; TAC15.LO=273;  
 3856 TAC18.LO=273; TAC20.LO=280; TAC26.LO=273;  
 3857 TAC29.LO=273; TAC37.LO=273; TAC40.LO=273;  
 3858 TC301.LO=200; TC302.LO=250; TC309.LO=270;  
 3859 TC310.LO=200; TC311.LO=270; TC312.LO=300;  
 3860 TC318.LO=250; TC319.LO=250; TC320.LO=250;  
 3861 TC322.LO=250; TC323.LO=300; TC326.LO=300;  
 3862 TC328.LO=300; TC329.LO=300; TC401.LO=260;  
 3863 TC402.LO=270; TC403.LO=280; TC406.LO=298;  
 3864 TC409.LO=400; TC411.LO=300; TC412.LO=330;  
 3865 TC413.LO=250; TC415.LO=250; TC417.LO=275;  
 3866 TC425.LO=300; TC426.LO=300; TC427.LO=360;  
 3867 TC428.LO=300; TC430.LO=300; TC431.LO=300;  
 3868 TC432.LO=350; TcwotE609A.LO=298; TcwotE621A.LO=298;  
 3869 TcwotE621B.LO=298; TcwotE627A.LO=295; TcwotE627B.LO=293;  
 3870 TcwotE641A.LO=295; TcwotE641B.LO=295; TcwotE603.LO=296.836;  
 3871 TcwotE605.LO=298; TcwotE611.LO=295; TcwotE613.LO=298;  
 3872 TcwotE617.LO=295; TcwotE626.LO=295; TcwotE634.LO=295;  
 3873 TcwotE640.LO=295; THC01.LO=295; THC02.LO=275;  
 3874 THC03.LO=290; THC04.LO=280; THC05.LO=270;  
 3875 THC06.LO=273; THC07.LO=273; THC11.LO=273;  
 3876 THC14.LO=273; THC16.LO=273; THC22.LO=273;  
 3877 THC23.LO=273; THC24.LO=273; THC25.LO=273;  
 3878 THC26.LO=273; THC27.LO=273; THC28.LO=270;  
 3879 THC29.LO=270; THC30.LO=250; THC31.LO=260;  
 3880 THC34.LO=250; THC38.LO=250; THC41.LO=250;  
 3881 THC45.LO=250; TmC601.LO=315; TmC603.LO=350;  
 \_Economic Optimization Program

05/15/01 16:49:39 PAGE 89  
GAMS 2.50A Windows NT/95/98

3882 TmC606A.LO=327; TmC606D.LO=370; TmK601.LO=273;

3883 TnC601.LO=310; TnC603.LO=320; TnC606A.LO=310;  
3884 TR1.LO=270; TR29.LO=260; TSC401.LO=280;  
3885 TSC404.LO=310; TSC406.LO=320; TSC407.LO=320;  
3886 TSC409.LO=308; TSC411.LO=308; TSC412.LO=308;  
3887 TSC414.LO=275; Utilities.LO=-10000; VFC614B.LO=0.1;  
3888 VFC615.LO=0.001; VFC616.LO=0.05; VFM3.LO=0;  
3889 VpC601.LO=1; VpC603.LO=0.01; VpC606A.LO=0.1;  
3890 x10AC09.LO=0; x10AC20.LO=0; x10AC31.LO=0;  
3891 x10AC42.LO=0; x11AC02.LO=0.97; x11AC05.LO=0.89;  
3892 x11AC07.LO=0.89; x11AC09.LO=0; x11AC15.LO=0.89;  
3893 x11AC18.LO=0.89; x11AC20.LO=0; x11AC26.LO=0.89;  
3894 x11AC29.LO=0.89; x11AC31.LO=0; x11AC37.LO=0.89;  
3895 x11AC40.LO=0.89; x11AC42.LO=0; x12AC02.LO=0.002;  
3896 x12AC05.LO=0.001; x12AC07.LO=0.001; x12AC09.LO=0;  
3897 x12AC12.LO=0.001; x12AC15.LO=0.001; x12AC18.LO=0.001;  
3898 x12AC20.LO=0; x12AC23.LO=0.001; x12AC26.LO=0.001;  
3899 x12AC29.LO=0.001; x12AC31.LO=0; x12AC34.LO=0.001;  
3900 x12AC37.LO=0.001; x12AC40.LO=0.001; x12AC42.LO=0;  
3901 x12AC45.LO=0.001; x1AC09.LO=0; x1AC20.LO=0;  
3902 x1AC31.LO=0; x1AC42.LO=0; x1C301.LO=0;  
3903 x1C302.LO=0; x1C303.LO=0.05; x1C306.LO=0;  
3904 x1C307.LO=0; x1C308.LO=0; x1C309.LO=0;  
3905 x1C310.LO=0; x1C311.LO=0; x1C312.LO=0;  
3906 x1C315.LO=0.0001; x1C317.LO=0; x1C318.LO=0.0001;  
3907 x1C319.LO=0.0001; x1C320.LO=0; x1C321.LO=0.0001;  
3908 x1C322.LO=0; x1C323.LO=0; x1C324.LO=0;  
3909 x1C326.LO=0.4; x1C328.LO=0.4; x1C329.LO=0.4;  
3910 x1C401.LO=0; x1C402.LO=0; x1C403.LO=0;  
3911 x1C404.LO=0; x1C405.LO=0; x1C406.LO=0;  
3912 x1C407.LO=0; x1C408.LO=0; x1C409.LO=0;  
3913 x1C410.LO=0.0001; x1C411.LO=0; x1C412.LO=0;  
3914 x1C413.LO=0; x1C414.LO=0; x1C415.LO=0;  
3915 x1C418.LO=0; x1C419.LO=0.0001; x1C425.LO=0;  
3916 x1C426.LO=0; x1C427.LO=0; x1C428.LO=0;  
3917 x1C430.LO=0; x1C431.LO=0; x1C432.LO=0;  
3918 x1HC01.LO=0.001; x1HC02.LO=0; x1HC03.LO=0.0001;  
3919 x1HC04.LO=0; x1HC05.LO=0; x1HC06.LO=0;  
3920 x1HC07.LO=0; x1HC08.LO=0; x1HC11.LO=0;  
3921 x1HC14.LO=0; x1HC15.LO=0; x1HC16.LO=0;  
3922 x1HC22.LO=0; x1HC23.LO=0; x1HC24.LO=0;  
3923 x1HC25.LO=0; x1HC26.LO=0; x1HC27.LO=0;  
3924 x1HC28.LO=0; x1HC29.LO=0; x1HC30.LO=0;  
3925 x1HC31.LO=0; x1HC33.LO=0; x1HC34.LO=0;  
3926 x1HC38.LO=0; x1HC40.LO=0; x1HC41.LO=0;  
3927 x1HC45.LO=0; x1R1.LO=0; x1R29.LO=0;  
\_Economic Optimization Program

3928 x1SC401.LO=0; x1SC404.LO=0; x1SC405.LO=0;  
3929 x1SC406.LO=0; x1SC407.LO=0; x1SC409.LO=0;  
3930 x1SC411.LO=0; x1SC412.LO=0; x1SC413.LO=0;  
3931 x1SC414.LO=0; x2AC09.LO=0; x2AC20.LO=0;  
3932 x2AC31.LO=0; x2AC42.LO=0; x2C301.LO=0;  
3933 x2C417.LO=0; x2C418.LO=0; x2C419.LO=0;  
3934 x2HC01.LO=0.1; x2HC02.LO=0.1; x2HC03.LO=0;  
3935 x2HC04.LO=0; x2HC05.LO=0; x2HC06.LO=0;  
3936 x2HC07.LO=0; x2HC08.LO=0; x2HC11.LO=0;  
3937 x2HC14.LO=0; x2HC15.LO=0; x2HC16.LO=0;  
3938 x2HC22.LO=0; x2HC23.LO=0; x2HC24.LO=0;  
3939 x2HC25.LO=0; x2HC26.LO=0; x2HC27.LO=0;  
3940 x2HC28.LO=0; x2HC29.LO=0; x2HC30.LO=0;  
3941 x2HC31.LO=0; x2R1.LO=0; x2R29.LO=0;  
3942 x2SC401.LO=0; x2SC404.LO=0; x2SC405.LO=0;  
3943 x2SC406.LO=0; x2SC407.LO=0; x2SC409.LO=0;  
3944 x2SC411.LO=0; x2SC412.LO=0; x2SC413.LO=0;  
3945 x2SC414.LO=0; x3AC09.LO=0; x3AC20.LO=0;  
3946 x3AC31.LO=0; x3AC42.LO=0; x3C301.LO=0.5;  
3947 x3C302.LO=0.45; x3C303.LO=0.5; x3C306.LO=0;  
3948 x3C307.LO=0; x3C308.LO=0; x3C309.LO=0.2;  
3949 x3C310.LO=0; x3C311.LO=0; x3C312.LO=0;  
3950 x3C315.LO=0.0001; x3C317.LO=0.5; x3C318.LO=0.0001;  
3951 x3C319.LO=0.0001; x3C320.LO=0.0001; x3C321.LO=0.0001;  
3952 x3C322.LO=0; x3C323.LO=0.5; x3C324.LO=0.5;  
3953 x3C326.LO=0; x3C328.LO=0; x3C329.LO=0;  
3954 x3C401.LO=0; x3C402.LO=0; x3C403.LO=0.0001;  
3955 x3C404.LO=0.0001; x3C405.LO=0; x3C406.LO=0;  
3956 x3C407.LO=0; x3C408.LO=0; x3C409.LO=0;  
3957 x3C410.LO=0.0001; x3C411.LO=0.0001; x3C412.LO=0;  
3958 x3C413.LO=0; x3C414.LO=0.5; x3C415.LO=0;  
3959 x3C418.LO=0.0001; x3C419.LO=0.0001; x3C425.LO=0;  
3960 x3C426.LO=0.0001; x3C427.LO=0; x3C428.LO=0;  
3961 x3C430.LO=0; x3C431.LO=0; x3C432.LO=0;  
3962 x3HC01.LO=0.01; x3HC02.LO=0; x3HC03.LO=0.1;  
3963 x3HC04.LO=0.1; x3HC05.LO=0.1; x3HC06.LO=0.3;  
3964 x3HC07.LO=0.3; x3HC08.LO=0.3; x3HC11.LO=0.3;  
3965 x3HC14.LO=0.3; x3HC15.LO=0.3; x3HC16.LO=0.3;  
3966 x3HC22.LO=0.1; x3HC23.LO=0.1; x3HC24.LO=0.1;  
3967 x3HC25.LO=0.1; x3HC26.LO=0.1; x3HC27.LO=0.1;  
3968 x3HC28.LO=0.1; x3HC29.LO=0.1; x3HC30.LO=0.1;  
3969 x3HC31.LO=0.1; x3HC33.LO=0.1; x3HC34.LO=0.1;  
3970 x3HC38.LO=0.1; x3HC40.LO=0.1; x3HC41.LO=0.1;

3971 x3HC45.LO=0.1; x3R1.LO=0; x3R29.LO=0.1;  
3972 x3SC401.LO=0.2; x3SC404.LO=0; x3SC405.LO=0;  
3973 x3SC406.LO=0; x3SC407.LO=0; x3SC409.LO=0.5;  
\_Economic Optimization Program

3974 x3SC411.LO=0.5; x3SC412.LO=0.5; x3SC413.LO=0.5;  
3975 x3SC414.LO=0.5; x4AC09.LO=0; x4AC20.LO=0;  
3976 x4AC31.LO=0; x4AC42.LO=0; x4C301.LO=0;  
3977 x4C302.LO=0; x4C303.LO=0.05; x4C306.LO=0;  
3978 x4C307.LO=0; x4C308.LO=0; x4C309.LO=0;  
3979 x4C310.LO=0; x4C311.LO=0; x4C312.LO=0;  
3980 x4C315.LO=0.0001; x4C317.LO=0; x4C318.LO=0.0001;  
3981 x4C319.LO=0.0001; x4C320.LO=0.0001; x4C321.LO=0.0001;  
3982 x4C322.LO=0; x4C323.LO=0.01; x4C324.LO=0.01;  
3983 x4C325.LO=0; x4C326.LO=0; x4C328.LO=0;  
3984 x4C329.LO=0; x4C401.LO=0.001; x4C402.LO=0.001;  
3985 x4C403.LO=0.0001; x4C404.LO=0.0001; x4C405.LO=0.0001;  
3986 x4C406.LO=0; x4C407.LO=0.01; x4C408.LO=0;  
3987 x4C409.LO=0; x4C410.LO=0.0001; x4C411.LO=0;  
3988 x4C412.LO=0.5; x4C413.LO=0.0001; x4C414.LO=0.01;  
3989 x4C415.LO=0.0001; x4C418.LO=0.0001; x4C419.LO=0.0001;  
3990 x4C425.LO=0; x4C426.LO=0.0001; x4C427.LO=0;  
3991 x4C428.LO=0; x4C430.LO=0.5; x4C431.LO=0.0001;  
3992 x4C432.LO=0.5; x4HC01.LO=0; x4HC02.LO=0;  
3993 x4HC03.LO=0; x4HC04.LO=0; x4HC05.LO=0;  
3994 x4HC06.LO=0; x4HC07.LO=0; x4HC08.LO=0;  
3995 x4HC11.LO=0; x4HC14.LO=0; x4HC15.LO=0;  
3996 x4HC16.LO=0; x4HC22.LO=0; x4HC23.LO=0;  
3997 x4HC24.LO=0; x4HC25.LO=0; x4HC26.LO=0;  
3998 x4HC27.LO=0; x4HC28.LO=0; x4HC29.LO=0;  
3999 x4HC30.LO=0; x4HC31.LO=0; x4HC33.LO=0;  
4000 x4HC34.LO=0; x4HC38.LO=0; x4HC40.LO=0;  
4001 x4HC41.LO=0; x4HC45.LO=0; x4R1.LO=0;  
4002 x4R29.LO=0.01; x4SC401.LO=0.5; x4SC404.LO=0.48;  
4003 x4SC405.LO=0.48; x4SC406.LO=0.7; x4SC407.LO=0.7;  
4004 x4SC409.LO=0; x4SC411.LO=0; x4SC412.LO=0;  
4005 x4SC413.LO=0; x4SC414.LO=0; x5AC09.LO=0;  
4006 x5AC20.LO=0; x5AC31.LO=0; x5AC42.LO=0;  
4007 x5C301.LO=0; x5C302.LO=0; x5C303.LO=0;  
4008 x5C306.LO=0; x5C307.LO=0; x5C308.LO=0;  
4009 x5C309.LO=0; x5C310.LO=0; x5C311.LO=0;  
4010 x5C312.LO=0; x5C315.LO=0.0001; x5C317.LO=0;  
4011 x5C318.LO=0.0001; x5C319.LO=0.0001; x5C320.LO=0;  
4012 x5C321.LO=0.0001; x5C322.LO=0; x5C323.LO=0.002;  
4013 x5C324.LO=0.002; x5C325.LO=0; x5C326.LO=0;  
4014 x5C328.LO=0; x5C329.LO=0; x5C401.LO=0;  
4015 x5C402.LO=0; x5C403.LO=0.0001; x5C404.LO=0;  
4016 x5C405.LO=0; x5C406.LO=0; x5C407.LO=0;  
4017 x5C408.LO=0; x5C409.LO=0; x5C410.LO=0.0001;  
4018 x5C411.LO=0; x5C412.LO=0; x5C413.LO=0;  
4019 x5C414.LO=0; x5C415.LO=0; x5C418.LO=0;  
\_Economic Optimization Program

4020 x5C419.LO=0.0001; x5C425.LO=0; x5C426.LO=0.0001;  
4021 x5C427.LO=0; x5C428.LO=0; x5C430.LO=0;  
4022 x5C431.LO=0; x5C432.LO=0; x5HC01.LO=0;  
4023 x5HC02.LO=0; x5HC03.LO=0; x5HC04.LO=0;  
4024 x5HC05.LO=0; x5HC06.LO=0; x5HC07.LO=0;  
4025 x5HC08.LO=0; x5HC11.LO=0; x5HC14.LO=0;  
4026 x5HC15.LO=0; x5HC16.LO=0; x5HC22.LO=0;  
4027 x5HC23.LO=0; x5HC24.LO=0; x5HC25.LO=0;  
4028 x5HC26.LO=0; x5HC27.LO=0; x5HC28.LO=0;  
4029 x5HC29.LO=0.01; x5HC30.LO=0; x5HC31.LO=0;  
4030 x5HC33.LO=0; x5HC34.LO=0; x5HC38.LO=0;  
4031 x5HC40.LO=0; x5HC41.LO=0; x5HC45.LO=0;  
4032 x5R1.LO=0; x5R29.LO=0.01; x5SC401.LO=0.008;  
4033 x5SC404.LO=0; x5SC405.LO=0; x5SC406.LO=0.01;  
4034 x5SC407.LO=0.01; x5SC409.LO=0; x5SC411.LO=0;  
4035 x5SC412.LO=0; x5SC413.LO=0; x5SC414.LO=0;  
4036 x6SC401.LO=0; x6SC404.LO=0; x6SC405.LO=0;  
4037 x6SC406.LO=0; x6SC407.LO=0; x6SC409.LO=0;  
4038 x6SC411.LO=0; x6SC412.LO=0; x6SC413.LO=0;  
4039 x6SC414.LO=0; x7AC09.LO=0; x7AC20.LO=0;  
4040 x7AC31.LO=0; x7AC42.LO=0; x7C301.LO=0;  
4041 x7C302.LO=0; x7C303.LO=0; x7C306.LO=0;  
4042 x7C307.LO=0; x7C308.LO=0; x7C309.LO=0;  
4043 x7C310.LO=0; x7C311.LO=0; x7C312.LO=0;  
4044 x7C315.LO=0; x7C316.LO=0; x7C317.LO=0;  
4045 x7C318.LO=0; x7C319.LO=0; x7C320.LO=0;  
4046 x7C321.LO=0; x7C322.LO=0; x7C323.LO=0;  
4047 x7C324.LO=0; x7C325.LO=0; x7C326.LO=0;  
4048 x7C328.LO=0; x7C329.LO=0; x7C401.LO=0;  
4049 x7C402.LO=0; x7C403.LO=0.0001; x7C404.LO=0.0001;  
4050 x7C405.LO=0.0001; x7C406.LO=0.001; x7C407.LO=0.01;  
4051 x7C408.LO=0; x7C409.LO=0; x7C410.LO=0.0001;  
4052 x7C411.LO=0; x7C412.LO=0; x7C413.LO=0;  
4053 x7C414.LO=0; x7C415.LO=0; x7C417.LO=0.0001;  
4054 x7C418.LO=0.0001; x7C419.LO=0; x7C425.LO=0.2;

4055 x7C426.LO=0.0001; x7C427.LO=0; x7C428.LO=0;  
4056 x7C430.LO=0; x7C431.LO=0; x7C432.LO=0;  
4057 x7HC01.LO=0; x7HC02.LO=0; x7HC03.LO=0;  
4058 x7HC04.LO=0; x7HC05.LO=0; x7HC06.LO=0;  
4059 x7HC07.LO=0; x7HC08.LO=0; x7HC11.LO=0;  
4060 x7HC14.LO=0; x7HC15.LO=0; x7HC16.LO=0;  
4061 x7HC22.LO=0; x7HC23.LO=0; x7HC24.LO=0;  
4062 x7HC25.LO=0; x7HC26.LO=0; x7HC27.LO=0;  
4063 x7HC28.LO=0; x7HC29.LO=0.1; x7HC30.LO=0.1;  
4064 x7HC31.LO=0.1; x7HC33.LO=0; x7HC34.LO=0;  
4065 x7HC38.LO=0; x7HC40.LO=0; x7HC41.LO=0;  
\_Economic Optimization Program

05/15/01 16:49:39 PAGE 93  
GAMS 2.50A Windows NT/95/98

4066 x7HC45.LO=0; x7R1.LO=0; x7R29.LO=0.1;  
4067 x7SC401.LO=0; x7SC404.LO=0; x7SC405.LO=0;  
4068 x7SC406.LO=0; x7SC407.LO=0; x7SC409.LO=0;  
4069 x7SC411.LO=0; x7SC412.LO=0; x7SC413.LO=0;  
4070 x7SC414.LO=0; x8AC09.LO=0; x8AC20.LO=0;  
4071 x8AC31.LO=0; x8AC42.LO=0; x9AC09.LO=0;  
4072 x9AC20.LO=0; x9AC31.LO=0; x9AC42.LO=0;  
4073 xAC02.LO=0.4; xAC05.LO=0.4; xAC07.LO=0.4;  
4074 xAC09.LO=0.4; xAC12.LO=0.4; xAC15.LO=0.4;  
4075 xAC18.LO=0.4; xAC20.LO=0.4; xAC23.LO=0.4;  
4076 xAC26.LO=0.4; xAC29.LO=0.4; xAC31.LO=0.4;  
4077 xAC34.LO=0.4; xAC37.LO=0.4; xAC40.LO=0.4;  
4078 xAC42.LO=0.4; xiC10AC09.LO=0; xiC10AC20.LO=0;  
4079 xiC10AC31.LO=0; xiC10AC42.LO=0; xiC11AC09.LO=0;  
4080 xiC11AC20.LO=0; xiC11AC31.LO=0; xiC11AC42.LO=0;  
4081 xM1C606D.LO=0; xM3C606D.LO=0; xM4C606D.LO=0;  
4082 xM5C606D.LO=0; xM7C606D.LO=0; xx1C302.LO=0;  
4083 xx1C308.LO=0; xx1C310.LO=0; xx1C311.LO=0;  
4084 xx1C312.LO=0; xx1C323.LO=0; xx1C325.LO=0.4;  
4085 xx1C405.LO=0; xx1C408.LO=0; xx1C425.LO=0;  
4086 xx1C428.LO=0; xx1C430.LO=0; xx1C431.LO=0;  
4087 xx1HC28.LO=0.01; xx1HC29.LO=0; xx1HC30.LO=0.01;  
4088 xx1HC32.LO=0; xx1R1.LO=0; xx1R29.LO=0;  
4089 xx1SC406.LO=0; xx1SC408.LO=0; xx2HC28.LO=0;  
4090 xx2HC29.LO=0; xx2HC30.LO=0; xx2R1.LO=0;  
4091 xx2R29.LO=0; xx2SC406.LO=0; xx2SC408.LO=0;  
4092 xx3C302.LO=0.5; xx3C308.LO=0; xx3C310.LO=0;  
4093 xx3C311.LO=0; xx3C312.LO=0; xx3C323.LO=0.5;  
4094 xx3C325.LO=0; xx3C405.LO=0; xx3C408.LO=0;  
4095 xx3C425.LO=0; xx3C428.LO=0; xx3C430.LO=0;  
4096 xx3C431.LO=0; xx3C432.LO=0; xx3HC28.LO=0.2;  
4097 xx3HC29.LO=0.1; xx3HC30.LO=0.1; xx3HC32.LO=0.3;  
4098 xx3R1.LO=0.1; xx3R29.LO=0.1; xx3SC406.LO=0;  
4099 xx3SC408.LO=0.5; xx4C302.LO=0; xx4C308.LO=0;  
4100 xx4C310.LO=0; xx4C311.LO=0; xx4C312.LO=0;  
4101 xx4C323.LO=0.08; xx4C325.LO=0; xx4C405.LO=0.0001;  
4102 xx4C408.LO=0; xx4C409.LO=0.0001; xx4C425.LO=0;  
4103 xx4C427.LO=0; xx4C428.LO=0; xx4C430.LO=0.5;  
4104 xx4C431.LO=0.0001; xx4C432.LO=0.5; xx4HC28.LO=0.01;  
4105 xx4HC29.LO=0.01; xx4HC30.LO=0.01; xx4HC32.LO=0;  
4106 xx4R1.LO=0; xx4R29.LO=0.01; xx4SC406.LO=0.6;  
4107 xx4SC408.LO=0; xx5C302.LO=0; xx5C308.LO=0;  
4108 xx5C310.LO=0; xx5C311.LO=0; xx5C312.LO=0;  
4109 xx5C323.LO=0.001; xx5C325.LO=0; xx5C405.LO=0.0001;  
4110 xx5C408.LO=0; xx5C425.LO=0; xx5C428.LO=0;  
4111 xx5C430.LO=0; xx5C431.LO=0; xx5HC28.LO=0.01;  
\_Economic Optimization Program

05/15/01 16:49:39 PAGE 94  
GAMS 2.50A Windows NT/95/98

4112 xx5HC29.LO=0; xx5HC30.LO=0; xx5HC32.LO=0;  
4113 xx5R1.LO=0; xx5R29.LO=0; xx5SC406.LO=0;  
4114 xx5SC408.LO=0; xx6SC406.LO=0; xx6SC408.LO=0;  
4115 xx7C302.LO=0; xx7C308.LO=0; xx7C310.LO=0;  
4116 xx7C311.LO=0; xx7C312.LO=0; xx7C323.LO=0.002;  
4117 xx7C325.LO=0; xx7C405.LO=0.0001; xx7C408.LO=0;  
4118 xx7C425.LO=0; xx7C428.LO=0; xx7C430.LO=0;  
4119 xx7C431.LO=0; xx7HC28.LO=0.1; xx7HC29.LO=0;  
4120 xx7HC30.LO=0.1; xx7HC32.LO=0; xx7R1.LO=0.1;  
4121 xx7R29.LO=0.1; xx7SC406.LO=0; xx7SC408.LO=0;  
4122 y1HC28.LO=0.05; y1HC29.LO=0.05; y1HC30.LO=0.05;  
4123 y1HC31.LO=0.05; y1R1.LO=0; y1R29.LO=0.05;  
4124 y2HC28.LO=0; y2HC29.LO=0; y2HC30.LO=0;  
4125 y2HC31.LO=0; y2R1.LO=0; y2R29.LO=0;  
4126 y3HC28.LO=0.2; y3HC29.LO=0.1; y3HC30.LO=0.1;  
4127 y3HC31.LO=0.1; y3R1.LO=0.1; y3R29.LO=0.1;  
4128 y4HC28.LO=0; y4HC29.LO=0; y4HC30.LO=0.01;  
4129 y4HC31.LO=0; y4R1.LO=0; y4R29.LO=0;  
4130 y5HC28.LO=0; y5HC29.LO=0; y5HC30.LO=0;  
4131 y5HC31.LO=0; y5R1.LO=0; y5R29.LO=0;  
4132 y7HC28.LO=0.01; y7HC29.LO=0; y7HC30.LO=0;  
4133 y7HC31.LO=0; y7R1.LO=0; y7R29.LO=0;  
4134 yy1HC28.LO=0.1; yy1HC29.LO=0.1; yy1HC30.LO=0.05;  
4135 yy1R1.LO=0.1; yy1R29.LO=0.05; yy2HC28.LO=0;  
4136 yy2HC29.LO=0; yy2HC30.LO=0; yy2R1.LO=0;  
4137 yy2R29.LO=0; yy3HC28.LO=0.1; yy3HC29.LO=0.1;  
4138 yy3HC30.LO=0.1; yy3R1.LO=0.1; yy3R29.LO=0.1;



4139 yy4HC28.LO=0.01; yy4HC29.LO=0.01; yy4HC30.LO=0.01;  
4140 yy4R1.LO=0; yy4R29.LO=0.01; yy5HC28.LO=0.001;  
4141 yy5HC29.LO=0; yy5HC30.LO=0; yy5R1.LO=0;  
4142 yy5R29.LO=0; yy7HC28.LO=0; yy7HC29.LO=0;  
4143 yy7HC30.LO=0; yy7R1.LO=0; yy7R29.LO=0;  
4144 C10pC623.UP=0.5; C10pC625.UP=0.5; C10pC627.UP=0.5;  
4145 C10pC629.UP=0.5; C2C623.UP=0.1; C2C625.UP=0.1;  
4146 C2C627.UP=0.1; C2C629.UP=0.1; C3C623.UP=6;  
4147 C3C625.UP=6; C3C627.UP=6; C3C629.UP=6;  
4148 C3pC623.UP=10; C3pC625.UP=10; C3pC627.UP=10;  
4149 C3pC629.UP=10; C4pC623.UP=1; C4pC625.UP=1;  
4150 C4pC627.UP=1; C4pC629.UP=1; C5pC623.UP=0.1;  
4151 C5pC625.UP=0.1; C5pC627.UP=0.1; C5pC629.UP=0.1;  
4152 C7pC623.UP=0.1; C7pC625.UP=0.1; C7pC627.UP=0.1;  
4153 C7pC629.UP=0.1; C8pC623.UP=0.1; C8pC625.UP=0.1;  
4154 C8pC627.UP=0.1; C8pC629.UP=0.1; C9pC623.UP=10;  
4155 C9pC625.UP=10; C9pC627.UP=10; C9pC629.UP=10;  
4156 CHXC623.UP=15; CHXC625.UP=15; CHXC627.UP=15;  
4157 CHXC629.UP=15; CiC10pC623.UP=1; CiC10pC625.UP=1;  
\_Economic Optimization Program

05/15/01 16:49:39 PAGE 95  
GAMS 2.50A Windows NT/95/98

4158 CiC10pC627.UP=1; CiC10pC629.UP=1; CiC11pC623.UP=0.1;  
4159 CiC11pC625.UP=0.1; CiC11pC627.UP=0.1; CiC11pC629.UP=0.1;  
4160 CiC4eC623.UP=0.1; CiC4eC625.UP=0.1; CiC4eC627.UP=0.1;  
4161 CiC4eC629.UP=0.1; CiC5eC623.UP=0.1; CiC5eC625.UP=0.1;  
4162 CiC5eC627.UP=0.1; CiC5eC629.UP=0.1; CiC8eC623.UP=0.3;  
4163 CiC8eC625.UP=0.3; CiC8eC627.UP=0.3; CiC8eC629.UP=0.3;  
4164 Cost.UP=10000; dTE601.UP=50; dTE602.UP=90;  
4165 dTE603.UP=50; dTE605.UP=50; dTE609A.UP=20;  
4166 dTE610.UP=50; dTE611.UP=50; dTE612.UP=90;  
4167 dTE613.UP=30; dTE616.UP=120; dTE617.UP=50;  
4168 dTE621A.UP=50; dTE621B.UP=40; dTE626.UP=50;  
4169 dTE627A.UP=55; dTE627B.UP=50; dTE628.UP=60;  
4170 dTE629.UP=80; dTE633.UP=50; dTE634.UP=20;  
4171 dTE640.UP=50; dTE641.UP=50; dTE695A.UP=90;  
4172 dTE695B.UP=60; dTE696A.UP=90; dTE696B.UP=90;  
4173 dTE6XX.UP=50; Earnings.UP=10000; f1C601.UP=0.1;  
4174 f1C603.UP=1; f1C606A.UP=1; f2C601.UP=1;  
4175 f3C601.UP=1; f3C603.UP=1; f3C606A.UP=1;  
4176 f4C601.UP=1; f4C603.UP=1; f4C606A.UP=1;  
4177 f5C601.UP=1; f5C603.UP=1; f5C606A.UP=1;  
4178 f6C601.UP=1; f7C601.UP=1; f7C603.UP=1;  
4179 f7C606A.UP=1; FAC05.UP=20; FAC07.UP=20;  
4180 FAC09.UP=20; FAC15.UP=20; FAC18.UP=20;  
4181 FAC20.UP=20; FAC26.UP=20; FAC29.UP=20;  
4182 FAC31.UP=20; FAC37.UP=20; FAC40.UP=20;  
4183 FAC42.UP=20; FC301.UP=6; FC302.UP=5;  
4184 FC303.UP=6; FC306.UP=15; FC307.UP=15;  
4185 FC309.UP=10; FC310.UP=3; FC311.UP=8;  
4186 FC312.UP=5; FC315.UP=5; FC317.UP=3;  
4187 FC318.UP=3; FC319.UP=3; FC321.UP=5;  
4188 FC323.UP=3; FC324.UP=3; FC325.UP=3;  
4189 FC326.UP=3; FC401.UP=5; FC402.UP=5;  
4190 FC404.UP=5; FC405.UP=2; FC406.UP=5;  
4191 FC408.UP=10; FC409.UP=10; FC410.UP=10;  
4192 FC411.UP=10; FC413.UP=1; FC414.UP=5;  
4193 FC415.UP=10; FC418.UP=5; FC419.UP=10;  
4194 FC425.UP=10; FC426.UP=5; FC427.UP=10;  
4195 FC428.UP=5; FC430.UP=10; FC431.UP=10;  
4196 FC432.UP=5; FcwE603.UP=20; FcwE605.UP=15;  
4197 FcwE609A.UP=1; FcwE611.UP=20; FcwE613.UP=15;  
4198 FcwE617.UP=25; FcwE621A.UP=10; FcwE621B.UP=20;  
4199 FcwE626.UP=20; FcwE627A.UP=10; FcwE627B.UP=30;  
4200 FcwE634.UP=60; FcwE640.UP=50; FcwE641A.UP=30;  
4201 FcwE641B.UP=10; FHC02.UP=5; FHC03.UP=10;  
4202 FHC04.UP=10; FHC05.UP=10; FHC06.UP=12;  
4203 FHC07.UP=5; FHC08.UP=5; FHC11.UP=5;  
\_Economic Optimization Program

05/15/01 16:49:39 PAGE 96  
GAMS 2.50A Windows NT/95/98

4204 FHC14.UP=5; FHC15.UP=5; FHC16.UP=5;  
4205 FHC22.UP=6; FHC23.UP=6; FHC24.UP=6;  
4206 FHC25.UP=6; FHC26.UP=6; FHC27.UP=10;  
4207 FHC28.UP=12; FHC29.UP=12; FHC30.UP=12;  
4208 FHC31.UP=12; FHC33.UP=1; FHC34.UP=1;  
4209 FHC38.UP=1; FHC40.UP=1; FHC41.UP=1;  
4210 FHC45.UP=1; FIHC28.UP=10; FIHC29.UP=12;  
4211 FIHC30.UP=12; FIHC31.UP=12; FIR1.UP=10;  
4212 FIR29.UP=12; FmC302.UP=0.1; FmC308.UP=0.5;  
4213 FmC310.UP=0.8; FmC311.UP=0.5; FmC312.UP=0.1;  
4214 FmC317.UP=0.1; FmC322.UP=1; FmC323.UP=0.4;  
4215 FmC325.UP=1; FmC405.UP=0.1; FmC407.UP=0.1;  
4216 FmC408.UP=2; FmC409.UP=0.2; FmC412.UP=0.1;  
4217 FmC414.UP=0.1; FmC425.UP=2; FmC427.UP=0.2;  
4218 FmC428.UP=0.1; FmC430.UP=0.2; FmC431.UP=1;  
4219 FmC432.UP=0.1; FmHC01.UP=0.1; FmHC32.UP=0.1;  
4220 FmIHC28.UP=0.2; FmIHC29.UP=0.1; FmIHC30.UP=0.1;  
4221 FmIR1.UP=0.2; FmIR29.UP=0.1; FmSC403.UP=0.1;  
4222 FmSC406.UP=0.1; FmSC408.UP=1; FmVHC28.UP=0.2;

4223 FmvHC29.UP=0.1; FmvHC30.UP=0.1; FmvR1.UP=0.2;  
4224 FmvR29.UP=0.1; FR1.UP=12; FR29.UP=12;  
4225 FSC401.UP=5; FSC403.UP=3; FSC404.UP=3;  
4226 FSC406.UP=3; FSC407.UP=3; FSC408.UP=3.2;  
4227 FSC409.UP=3.2; FSC412.UP=1; FSC414.UP=0.5;  
4228 FstmE602.UP=1; FstmE695A.UP=10; FstmE695B.UP=10;  
4229 FstmE696A.UP=10; FstmE696B.UP=10; FvHC28.UP=8;  
4230 FvHC29.UP=12; FvHC30.UP=12; FvHC31.UP=12;  
4231 FvR1.UP=12; FvR29.UP=12; h1C601.UP=2;  
4232 h1C603.UP=1; h1C606A.UP=10; h2C601.UP=5;  
4233 h3C601.UP=6; h3C603.UP=1; h3C606A.UP=-35;  
4234 h4C601.UP=2; h4C603.UP=1; h4C606A.UP=1;  
4235 h5C601.UP=1.5; h5C603.UP=1.5; h5C606A.UP=2;  
4236 h6C601.UP=3; h7C601.UP=1.5; h7C603.UP=1.5;  
4237 h7C606A.UP=1; hAC02.UP=10000; hAC05.UP=10000;  
4238 hAC07.UP=10000; hAC09.UP=10000; hAC12.UP=10000;  
4239 hAC15.UP=10000; hAC18.UP=10000; hAC20.UP=10000;  
4240 hAC23.UP=10000; hAC26.UP=10000; hAC29.UP=10000;  
4241 hAC31.UP=10000; hAC34.UP=10000; hAC37.UP=10000;  
4242 hAC40.UP=10000; hAC42.UP=10000; hacAC09.UP=10000;  
4243 hacAC20.UP=10000; hacAC31.UP=10000; hacAC42.UP=10000;  
4244 hc301.UP=10000; hc302.UP=5000; hc303.UP=10000;  
4245 hc306.UP=10000; hc307.UP=10000; hc308.UP=10000;  
4246 hc309.UP=10000; hc310.UP=5000; hc311.UP=10000;  
4247 hc312.UP=10000; hc312liq.UP=10000; hc315.UP=10000;  
4248 hc316.UP=10000; hc317.UP=10000; hc318.UP=10000;  
4249 hc319.UP=10000; hc321.UP=5000; hc322.UP=5000;  
\_Economic Optimization Program

05/15/01 16:49:39 PAGE 97  
GAMS 2.50A Windows NT/95/98

4250 hc323.UP=10000; hc324.UP=10000; hc325.UP=10000;  
4251 hc326.UP=5000; hc329.UP=5000; hc401.UP=5000;  
4252 hc402.UP=10000; hc403.UP=10000; hc404.UP=10000;  
4253 hc405.UP=5000; hc406.UP=5000; hc407.UP=5000;  
4254 hc408.UP=10000; hc408vap.UP=10000; hc409.UP=10000;  
4255 hc410.UP=10000; hc410vap.UP=10000; hc411.UP=10000;  
4256 hc412.UP=5000; hc412liq.UP=1000; hc413.UP=5000;  
4257 hc414.UP=10000; hc414liq.UP=10000; hc415.UP=5000;  
4258 hc417.UP=5000; hc418.UP=10000; hc419.UP=10000;  
4259 hc425.UP=10000; hc426.UP=5000; hc427.UP=10000;  
4260 hc428.UP=10000; hc430.UP=10000; hc431.UP=10000;  
4261 hc432.UP=10000; hc623.UP=5000; hc625.UP=5000;  
4262 hc627.UP=5000; hc629.UP=5000; hHC01.UP=5000;  
4263 hHC02.UP=5000; hHC03.UP=10000; hHC04.UP=10000;  
4264 hHC05.UP=10000; hHC06.UP=10000; hHC07.UP=5000;  
4265 hHC11.UP=5000; hHC14.UP=5000; hHC16.UP=5000;  
4266 hHC29.UP=10000; hHC30.UP=10000; hHC31.UP=10000;  
4267 hHC32.UP=5000; hHC34.UP=5000; hHC38.UP=5000;  
4268 hHC41.UP=5000; hHC45.UP=5000; hHC29.UP=10000;  
4269 hHC30.UP=10000; hHC31.UP=10000; hR1.UP=10000;  
4270 hR29.UP=10000; hR1.UP=10000; hR29.UP=10000;  
4271 hSC401.UP=10000; hSC402.UP=10000; hSC403.UP=10000;  
4272 hSC404.UP=10000; hSC405.UP=10000; hSC406.UP=10000;  
4273 hSC407.UP=10000; hSC408.UP=10000; hSC409.UP=5000;  
4274 hSC411.UP=5000; hSC412.UP=10000; hSC413.UP=10000;  
4275 hSC414.UP=500; hvHC29.UP=10000; hvHC30.UP=10000;  
4276 hvHC31.UP=10000; hvR1.UP=10000; hvR29.UP=10000;  
4277 K1C323.UP=3; K1C325.UP=2; K1C408.UP=15;  
4278 K1C414.UP=4; K1C428.UP=10; K1C430.UP=6;  
4279 K1C601.UP=3; K1C603.UP=3; K1C606A.UP=3;  
4280 K1C606C.UP=7; K1C614B.UP=3.5; K1C615\_A.UP=4;  
4281 K1C616\_A.UP=5; K1E633.UP=5.5; K1E6XX.UP=5.5;  
4282 K1SC406.UP=5; K1SC408.UP=3.5; K2C601.UP=1;  
4283 K2E633.UP=1.5; K2E6XX.UP=1.5; K2SC406.UP=1.2;  
4284 K2SC408.UP=1; K3C323.UP=1.5; K3C325.UP=1.5;  
4285 K3C408.UP=6; K3C414.UP=3; K3C428.UP=5;  
4286 K3C430.UP=5; K3C601.UP=2; K3C603.UP=1;  
4287 K3C606A.UP=3; K3C606C.UP=5; K3C614B.UP=1.5;  
4288 K3C615\_A.UP=2; K3C616\_A.UP=2; K3E633.UP=2;  
4289 K3E6XX.UP=3; K3SC406.UP=2; K3SC408.UP=1.5;  
4290 K4C323.UP=1; K4C325.UP=1; K4C408.UP=5;  
4291 K4C414.UP=2; K4C428.UP=5; K4C430.UP=3;  
4292 K4C601.UP=1; K4C603.UP=1; K4C606A.UP=3;  
4293 K4C606C.UP=4; K4C614B.UP=1; K4C615\_A.UP=1.5;  
4294 K4C616\_A.UP=1.5; K4E633.UP=1.5; K4E6XX.UP=1.5;  
4295 K4SC406.UP=1.5; K4SC408.UP=1; K5C323.UP=0.6;  
\_Economic Optimization Program

05/15/01 16:49:39 PAGE 98  
GAMS 2.50A Windows NT/95/98

4296 K5C325.UP=0.6; K5C408.UP=3; K5C414.UP=2;  
4297 K5C428.UP=2; K5C430.UP=1.5; K5C601.UP=0.5;  
4298 K5C603.UP=0.5; K5C606A.UP=1; K5C606C.UP=1.2;  
4299 K5C614B.UP=0.8; K5C615\_A.UP=1; K5C616\_A.UP=1;  
4300 K5E633.UP=1; K5E6XX.UP=1; K5SC406.UP=0.6;  
4301 K5SC408.UP=0.6; K6C601.UP=1; K6SC406.UP=0.5;  
4302 K6SC408.UP=0.5; K7C323.UP=0.3; K7C325.UP=0.2;  
4303 K7C408.UP=1; K7C414.UP=1; K7C428.UP=2;  
4304 K7C430.UP=1; K7C601.UP=0.5; K7C603.UP=0.5;  
4305 K7C606A.UP=0.5; K7C614B.UP=0.1; K7C615\_A.UP=1;  
4306 K7C616\_A.UP=1; K7E633.UP=0.1; K7E6XX.UP=0.1;

4307 K7SC406.UP=0.3; K7SC408.UP=0.2; Kp1C601.UP=5;  
4308 Kp1C603.UP=3; Kp1C606A.UP=5; Kp1C606D.UP=12;  
4309 Kp2C601.UP=1.5; Kp3C601.UP=2; Kp3C603.UP=1.5;  
4310 Kp3C606A.UP=3; Kp3C606D.UP=5; Kp4C601.UP=1.5;  
4311 Kp4C603.UP=1; Kp4C606A.UP=3; Kp4C606D.UP=5;  
4312 Kp5C601.UP=1; Kp5C603.UP=0.5; Kp5C606A.UP=1;  
4313 Kp5C606D.UP=5; Kp6C601.UP=1; Kp7C601.UP=1;  
4314 Kp7C603.UP=0.3; Kp7C606A.UP=0.5; Kp7C606D.UP=5;  
4315 kWad1.UP=300; kWad2.UP=355; LpC601.UP=5;  
4316 LpC603.UP=10; LpC606A.UP=5; PC303.UP=140;  
4317 PC306.UP=900; PC307.UP=850; PC308.UP=800;  
4318 PC309.UP=780; PC311.UP=400; PC312.UP=850;  
4319 PHC30.UP=140; PHC32.UP=200; PR29.UP=140;  
4320 Profit.UP=10000; Q2HC07.UP=1; Q2HC11.UP=1;  
4321 Q2HC14.UP=1; Q2HC16.UP=1; qFp1C606A.UP=1;  
4322 qFp3C606A.UP=0.1; qFp4C606A.UP=1; qFp5C606A.UP=1;  
4323 qFp7C606A.UP=1; qS1C606A.UP=1; qS3C606A.UP=1;  
4324 qS4C606A.UP=0.5; qS5C606A.UP=0.55; qS7C606A.UP=0.16;  
4325 r10C623.UP=0.1; r10C625.UP=0.1; r10C627.UP=0.1;  
4326 r10C629.UP=0.1; r2C623.UP=0.832; r2C625.UP=0.832;  
4327 r2C627.UP=0.832; r2C629.UP=0.832; r3C623.UP=0.15;  
4328 r3C625.UP=0.15; r3C627.UP=0.15; r3C629.UP=0.15;  
4329 r4C623.UP=0.03; r4C625.UP=0.03; r4C627.UP=0.03;  
4330 r4C629.UP=0.03; r5C623.UP=0.3; r5C625.UP=0.3;  
4331 r5C627.UP=0.3; r5C629.UP=0.3; r7C623.UP=0.05;  
4332 r7C625.UP=0.05; r7C627.UP=0.05; r7C629.UP=0.05;  
4333 r8C623.UP=0.1; r8C625.UP=0.1; r8C627.UP=0.1;  
4334 r8C629.UP=0.1; r9C623.UP=0.1; r9C625.UP=0.1;  
4335 r9C627.UP=0.1; r9C629.UP=0.1; rho2HC07.UP=650;  
4336 rho2HC11.UP=650; rho2HC14.UP=650; rho2HC16.UP=650;  
4337 rhoAC09.UP=1700; rhoAC20.UP=1700; rhoAC31.UP=1700;  
4338 rhoAC42.UP=1700; riC10C623.UP=0.3; riC10C625.UP=0.3;  
4339 riC10C627.UP=0.3; riC10C629.UP=0.3; riC11C623.UP=0.1;  
4340 riC11C625.UP=0.1; riC11C627.UP=0.1; riC11C629.UP=0.1;  
4341 sf1S34.UP=1; sf2S34.UP=1; sfS11.UP=0.8;  
\_Economic Optimization Program

05/15/01 16:49:39 PAGE 99  
GAMS 2.50A Windows NT/95/98

4342 sfS19.UP=0.8; sfS2.UP=1; sfS23.UP=0.8;  
4343 sfS27.UP=0.8; sfS41.UP=1; sfS42.UP=1;  
4344 sfS5.UP=0.5; sfS7.UP=0.8; Sm1C601.UP=5;  
4345 Sm1C603.UP=1; Sm1C606A.UP=5; Sm1C606D.UP=5;  
4346 Sm2C601.UP=1; Sm3C601.UP=2; Sm3C603.UP=0.5;  
4347 Sm3C606A.UP=5; Sm3C606D.UP=10; Sm4C601.UP=1.5;  
4348 Sm4C603.UP=0.5; Sm4C606A.UP=5; Sm4C606D.UP=5;  
4349 Sm5C601.UP=0.6; Sm5C603.UP=0.5; Sm5C606A.UP=5;  
4350 Sm5C606D.UP=5; Sm6C601.UP=1; Sm7C601.UP=0.2;  
4351 Sm7C603.UP=0.2; Sm7C606A.UP=5; Sm7C606D.UP=5;  
4352 Sn1C601.UP=5; Sn1C603.UP=3; Sn1C606A.UP=20;  
4353 Sn2C601.UP=1.5; Sn3C601.UP=1.5; Sn3C603.UP=1.5;  
4354 Sn3C606A.UP=15; Sn4C601.UP=1; Sn4C603.UP=1;  
4355 Sn4C606A.UP=10; Sn5C601.UP=0.8; Sn5C603.UP=0.4;  
4356 Sn5C606A.UP=10; Sn6C601.UP=1; Sn7C601.UP=0.5;  
4357 Sn7C603.UP=0.5; Sn7C606A.UP=5; TAC02.UP=290;  
4358 TAC05.UP=300; TAC07.UP=300; TAC15.UP=300;  
4359 TAC18.UP=300; TAC20.UP=300; TAC26.UP=300;  
4360 TAC29.UP=300; TAC37.UP=300; TAC40.UP=300;  
4361 TC301.UP=300; TC302.UP=290; TC309.UP=350;  
4362 TC310.UP=310; TC311.UP=310; TC312.UP=369;  
4363 TC318.UP=365; TC319.UP=400; TC320.UP=400;  
4364 TC322.UP=400; TC323.UP=420; TC326.UP=360;  
4365 TC328.UP=360; TC329.UP=375; TC401.UP=300;  
4366 TC402.UP=305; TC403.UP=320; TC406.UP=400;  
4367 TC409.UP=461; TC411.UP=418; TC412.UP=405;  
4368 TC413.UP=350; TC415.UP=400; TC417.UP=350;  
4369 TC425.UP=410; TC426.UP=410; TC427.UP=405;  
4370 TC428.UP=405; TC430.UP=400; TC431.UP=405;  
4371 TC432.UP=400; TcwotE609A.UP=320; TcwotE621A.UP=355;  
4372 TcwotE621B.UP=325; TcwotE627A.UP=360; TcwotE627B.UP=310;  
4373 TcwotE641A.UP=360; TcwotE641B.UP=325; TcwotE603.UP=350;  
4374 TcwotE605.UP=320; TcwotE611.UP=350; TcwotE613.UP=320;  
4375 TcwotE617.UP=350; TcwotE626.UP=310; TcwotE634.UP=360;  
4376 TcwotE640.UP=330; THC01.UP=370; THC02.UP=302;  
4377 THC03.UP=360; THC04.UP=310; THC05.UP=300;  
4378 THC06.UP=300; THC07.UP=300; THC11.UP=300;  
4379 THC14.UP=300; THC16.UP=300; THC22.UP=290;  
4380 THC23.UP=290; THC24.UP=290; THC25.UP=290;  
4381 THC26.UP=290; THC27.UP=290; THC28.UP=290;  
4382 THC29.UP=290; THC30.UP=300; THC31.UP=310;  
4383 THC34.UP=310; THC38.UP=310; THC41.UP=310;  
4384 THC45.UP=310; TmC601.UP=360; TmC603.UP=375;  
4385 TmC606A.UP=370; TmC606D.UP=400; TmK601.UP=333;  
4386 TnC601.UP=340; TnC603.UP=375; TnC606A.UP=370;  
4387 TR1.UP=290; TR29.UP=300; TSC401.UP=350;  
\_Economic Optimization Program

05/15/01 16:49:39 PAGE 100  
GAMS 2.50A Windows NT/95/98

4388 TSC404.UP=365; TSC406.UP=360; TSC407.UP=400;  
4389 TSC409.UP=360; TSC411.UP=375; TSC412.UP=360;  
4390 TSC414.UP=320; Utilities.UP=10000; VFC614B.UP=0.8;

4391 VFC615.UP=0.6; VFC616.UP=1; VFM3.UP=0.55;  
 4392 VpC601.UP=5; VpC603.UP=3; VpC606A.UP=10;  
 4393 x10AC09.UP=0.1; x10AC20.UP=0.1; x10AC31.UP=0.1;  
 4394 x10AC42.UP=0.1; x11AC02.UP=0.998; x11AC05.UP=0.999;  
 4395 x11AC07.UP=0.999; x11AC09.UP=1; x11AC15.UP=0.999;  
 4396 x11AC18.UP=0.999; x11AC20.UP=1; x11AC26.UP=0.999;  
 4397 x11AC29.UP=0.999; x11AC31.UP=1; x11AC37.UP=0.999;  
 4398 x11AC40.UP=0.999; x11AC42.UP=1; x12AC02.UP=0.03;  
 4399 x12AC05.UP=0.11; x12AC07.UP=0.11; x12AC09.UP=0.1;  
 4400 x12AC12.UP=0.12; x12AC15.UP=0.11; x12AC18.UP=0.11;  
 4401 x12AC20.UP=0.1; x12AC23.UP=0.12; x12AC26.UP=0.11;  
 4402 x12AC29.UP=0.11; x12AC31.UP=0.1; x12AC34.UP=0.12;  
 4403 x12AC37.UP=0.11; x12AC40.UP=0.11; x12AC42.UP=0.1;  
 4404 x12AC45.UP=0.12; x1AC09.UP=0.1; x1AC20.UP=0.1;  
 4405 x1AC31.UP=0.1; x1AC42.UP=0.1; x1C301.UP=0.2;  
 4406 x1C302.UP=0.2; x1C303.UP=0.22; x1C306.UP=0.5;  
 4407 x1C307.UP=0.5; x1C308.UP=0.4; x1C309.UP=0.5;  
 4408 x1C310.UP=0.5; x1C311.UP=0.2; x1C312.UP=1;  
 4409 x1C315.UP=1; x1C317.UP=0.3; x1C318.UP=0.3;  
 4410 x1C319.UP=0.1; x1C320.UP=0.1; x1C321.UP=0.1;  
 4411 x1C322.UP=0.15; x1C323.UP=0.2; x1C324.UP=0.3;  
 4412 x1C326.UP=1; x1C328.UP=1; x1C329.UP=1;  
 4413 x1C401.UP=0.2; x1C402.UP=0.2; x1C403.UP=0.2;  
 4414 x1C404.UP=0.2; x1C405.UP=0.01; x1C406.UP=0.01;  
 4415 x1C407.UP=0.01; x1C408.UP=1; x1C409.UP=0.01;  
 4416 x1C410.UP=1; x1C411.UP=0.1; x1C412.UP=0.05;  
 4417 x1C413.UP=0.1; x1C414.UP=0.25; x1C415.UP=0.2;  
 4418 x1C418.UP=0.3; x1C419.UP=0.2; x1C425.UP=0.1;  
 4419 x1C426.UP=0.1; x1C427.UP=1; x1C428.UP=0.1;  
 4420 x1C430.UP=0.1; x1C431.UP=0.1; x1C432.UP=0.1;  
 4421 x1HC01.UP=0.3; x1HC02.UP=0.3; x1HC03.UP=0.2;  
 4422 x1HC04.UP=0.2; x1HC05.UP=0.2; x1HC06.UP=0.2;  
 4423 x1HC07.UP=0.2; x1HC08.UP=0.2; x1HC11.UP=0.2;  
 4424 x1HC14.UP=0.2; x1HC15.UP=0.2; x1HC16.UP=0.2;  
 4425 x1HC22.UP=0.5; x1HC23.UP=0.5; x1HC24.UP=0.5;  
 4426 x1HC25.UP=0.5; x1HC26.UP=0.5; x1HC27.UP=0.5;  
 4427 x1HC28.UP=0.2; x1HC29.UP=0.2; x1HC30.UP=0.2;  
 4428 x1HC31.UP=0.1; x1HC33.UP=0.1; x1HC34.UP=0.1;  
 4429 x1HC38.UP=0.1; x1HC40.UP=0.1; x1HC41.UP=0.1;  
 4430 x1HC45.UP=0.1; x1R1.UP=0.1; x1R29.UP=0.2;  
 4431 x1SC401.UP=0.1; x1SC404.UP=0.1; x1SC405.UP=0.1;  
 4432 x1SC406.UP=0.1; x1SC407.UP=0.1; x1SC409.UP=0.1;  
 4433 x1SC411.UP=0.1; x1SC412.UP=0.1; x1SC413.UP=0.1;  
 \_Economic Optimization Program

4434 x1SC414.UP=0.1; x2AC09.UP=1; x2AC20.UP=1;  
 4435 x2AC31.UP=1; x2AC42.UP=1; x2C301.UP=0.01;  
 4436 x2C417.UP=0.1; x2C418.UP=0.1; x2C419.UP=0.1;  
 4437 x2HC01.UP=0.7; x2HC02.UP=1; x2HC03.UP=0.1;  
 4438 x2HC04.UP=0.1; x2HC05.UP=0.1; x2HC06.UP=0.15;  
 4439 x2HC07.UP=0.15; x2HC08.UP=0.15; x2HC11.UP=0.15;  
 4440 x2HC14.UP=0.15; x2HC15.UP=0.15; x2HC16.UP=0.15;  
 4441 x2HC22.UP=0.1; x2HC23.UP=0.1; x2HC24.UP=0.1;  
 4442 x2HC25.UP=0.1; x2HC26.UP=0.1; x2HC27.UP=0.1;  
 4443 x2HC28.UP=0.1; x2HC29.UP=0.1; x2HC30.UP=0.1;  
 4444 x2HC31.UP=0.1; x2R1.UP=0.1; x2R29.UP=0.1;  
 4445 x2SC401.UP=0.1; x2SC404.UP=0.1; x2SC405.UP=0.1;  
 4446 x2SC406.UP=0.1; x2SC407.UP=0.1; x2SC409.UP=0.1;  
 4447 x2SC411.UP=0.1; x2SC412.UP=0.1; x2SC413.UP=0.1;  
 4448 x2SC414.UP=0.1; x3AC09.UP=0.7; x3AC20.UP=0.7;  
 4449 x3AC31.UP=0.7; x3AC42.UP=0.7; x3C301.UP=1;  
 4450 x3C302.UP=1; x3C303.UP=0.8; x3C306.UP=1;  
 4451 x3C307.UP=1; x3C308.UP=1; x3C309.UP=0.8;  
 4452 x3C310.UP=1; x3C311.UP=1; x3C312.UP=1;  
 4453 x3C315.UP=1; x3C317.UP=1; x3C318.UP=1;  
 4454 x3C319.UP=1; x3C320.UP=1; x3C321.UP=1;  
 4455 x3C322.UP=1; x3C323.UP=0.95; x3C324.UP=0.95;  
 4456 x3C326.UP=0.5; x3C328.UP=0.5; x3C329.UP=0.5;  
 4457 x3C401.UP=1; x3C402.UP=0.8; x3C403.UP=1;  
 4458 x3C404.UP=1; x3C405.UP=0.1; x3C406.UP=0.01;  
 4459 x3C407.UP=0.01; x3C408.UP=1; x3C409.UP=0.01;  
 4460 x3C410.UP=0.1; x3C411.UP=0.2; x3C412.UP=0.1;  
 4461 x3C413.UP=0.1; x3C414.UP=1; x3C415.UP=1;  
 4462 x3C418.UP=1; x3C419.UP=1; x3C425.UP=0.1;  
 4463 x3C426.UP=0.1; x3C427.UP=1; x3C428.UP=0.3;  
 4464 x3C430.UP=0.1; x3C431.UP=0.1; x3C432.UP=0.1;  
 4465 x3HC01.UP=0.6; x3HC02.UP=0.5; x3HC03.UP=1;  
 4466 x3HC04.UP=1; x3HC05.UP=1; x3HC06.UP=1;  
 4467 x3HC07.UP=1; x3HC08.UP=1; x3HC11.UP=1;  
 4468 x3HC14.UP=1; x3HC15.UP=1; x3HC16.UP=1;  
 4469 x3HC22.UP=0.9; x3HC23.UP=0.9; x3HC24.UP=0.9;  
 4470 x3HC25.UP=0.9; x3HC26.UP=0.9; x3HC27.UP=0.9;  
 4471 x3HC28.UP=0.6; x3HC29.UP=0.6; x3HC30.UP=0.6;  
 4472 x3HC31.UP=0.6; x3HC33.UP=1; x3HC34.UP=1;  
 4473 x3HC38.UP=1; x3HC40.UP=1; x3HC41.UP=1;  
 4474 x3HC45.UP=1; x3R1.UP=0.6; x3R29.UP=0.6;  
 4475 x3SC401.UP=0.4; x3SC404.UP=0.1; x3SC405.UP=0.1;  
 4476 x3SC406.UP=0.1; x3SC407.UP=0.1; x3SC409.UP=1;  
 4477 x3SC411.UP=1; x3SC412.UP=1; x3SC413.UP=1;  
 4478 x3SC414.UP=1; x4AC09.UP=0.2; x4AC20.UP=0.2;

4479 x4AC31.UP=0.2; x4AC42.UP=0.2; x4C301.UP=0.5;  
\_Economic Optimization Program

05/15/01 16:49:39 PAGE 102  
GAMS 2.50A Windows NT/95/98

4480 x4C302.UP=0.5; x4C303.UP=0.2; x4C306.UP=0.8;  
4481 x4C307.UP=0.8; x4C308.UP=0.5; x4C309.UP=0.4;  
4482 x4C310.UP=0.3; x4C311.UP=0.5; x4C312.UP=1;  
4483 x4C315.UP=0.3; x4C317.UP=0.2; x4C318.UP=0.3;  
4484 x4C319.UP=0.3; x4C320.UP=0.3; x4C321.UP=0.3;  
4485 x4C322.UP=0.4; x4C323.UP=0.25; x4C324.UP=0.25;  
4486 x4C325.UP=0.1; x4C326.UP=0.1; x4C328.UP=0.1;  
4487 x4C329.UP=0.1; x4C401.UP=0.5; x4C402.UP=0.5;  
4488 x4C403.UP=0.3; x4C404.UP=0.3; x4C405.UP=0.2;  
4489 x4C406.UP=0.2; x4C407.UP=0.3; x4C408.UP=0.2;  
4490 x4C409.UP=0.3; x4C410.UP=1; x4C411.UP=1;  
4491 x4C412.UP=1; x4C413.UP=1; x4C414.UP=0.25;  
4492 x4C415.UP=0.3; x4C418.UP=0.3; x4C419.UP=0.3;  
4493 x4C425.UP=1; x4C426.UP=1; x4C427.UP=1;  
4494 x4C428.UP=1; x4C430.UP=1; x4C431.UP=1;  
4495 x4C432.UP=1; x4HC01.UP=0.25; x4HC02.UP=0.25;  
4496 x4HC03.UP=0.3; x4HC04.UP=0.5; x4HC05.UP=0.5;  
4497 x4HC06.UP=0.4; x4HC07.UP=0.4; x4HC08.UP=0.4;  
4498 x4HC11.UP=0.4; x4HC14.UP=0.4; x4HC15.UP=0.4;  
4499 x4HC16.UP=0.4; x4HC22.UP=0.5; x4HC23.UP=0.5;  
4500 x4HC24.UP=0.5; x4HC25.UP=0.5; x4HC26.UP=0.5;  
4501 x4HC27.UP=0.5; x4HC28.UP=0.5; x4HC29.UP=0.3;  
4502 x4HC30.UP=0.3; x4HC31.UP=0.3; x4HC33.UP=0.5;  
4503 x4HC34.UP=0.5; x4HC38.UP=0.5; x4HC40.UP=0.5;  
4504 x4HC41.UP=0.5; x4HC45.UP=0.5; x4R1.UP=0.3;  
4505 x4R29.UP=0.3; x4SC401.UP=0.7; x4SC404.UP=1;  
4506 x4SC405.UP=1; x4SC406.UP=1; x4SC407.UP=1;  
4507 x4SC409.UP=0.1; x4SC411.UP=0.1; x4SC412.UP=0.1;  
4508 x4SC413.UP=0.1; x4SC414.UP=0.1; x5AC09.UP=0.1;  
4509 x5AC20.UP=0.1; x5AC31.UP=0.1; x5AC42.UP=0.1;  
4510 x5C301.UP=0.2; x5C302.UP=0.1; x5C303.UP=0.1;  
4511 x5C306.UP=0.6; x5C307.UP=0.6; x5C308.UP=0.2;  
4512 x5C309.UP=0.2; x5C310.UP=0.1; x5C311.UP=0.2;  
4513 x5C312.UP=0.4; x5C315.UP=0.1; x5C317.UP=0.1;  
4514 x5C318.UP=0.1; x5C319.UP=0.1; x5C320.UP=0.1;  
4515 x5C321.UP=0.1; x5C322.UP=0.1; x5C323.UP=0.1;  
4516 x5C324.UP=0.1; x5C325.UP=0.01; x5C326.UP=0.01;  
4517 x5C328.UP=0.01; x5C329.UP=0.01; x5C401.UP=0.5;  
4518 x5C402.UP=0.5; x5C403.UP=0.2; x5C404.UP=0.2;  
4519 x5C405.UP=0.2; x5C406.UP=0.2; x5C407.UP=0.2;  
4520 x5C408.UP=0.2; x5C409.UP=0.3; x5C410.UP=1;  
4521 x5C411.UP=1; x5C412.UP=0.1; x5C413.UP=0.3;  
4522 x5C414.UP=0.1; x5C415.UP=0.1; x5C418.UP=0.1;  
4523 x5C419.UP=0.1; x5C425.UP=1; x5C426.UP=1;  
4524 x5C427.UP=1; x5C428.UP=0.4; x5C430.UP=0.1;  
4525 x5C431.UP=0.2; x5C432.UP=0.1; x5HC01.UP=0.15;  
\_Economic Optimization Program

05/15/01 16:49:39 PAGE 103  
GAMS 2.50A Windows NT/95/98

4526 x5HC02.UP=0.15; x5HC03.UP=0.1; x5HC04.UP=0.3;  
4527 x5HC05.UP=0.3; x5HC06.UP=0.3; x5HC07.UP=0.3;  
4528 x5HC08.UP=0.3; x5HC11.UP=0.3; x5HC14.UP=0.3;  
4529 x5HC15.UP=0.3; x5HC16.UP=0.3; x5HC22.UP=0.5;  
4530 x5HC23.UP=0.5; x5HC24.UP=0.5; x5HC25.UP=0.5;  
4531 x5HC26.UP=0.5; x5HC27.UP=0.5; x5HC28.UP=0.5;  
4532 x5HC29.UP=0.3; x5HC30.UP=0.3; x5HC31.UP=0.3;  
4533 x5HC33.UP=2.5; x5HC34.UP=2.5; x5HC38.UP=2.5;  
4534 x5HC40.UP=2.5; x5HC41.UP=2.5; x5HC45.UP=2.5;  
4535 x5R1.UP=0.3; x5R29.UP=0.4; x5SC401.UP=0.1;  
4536 x5SC404.UP=0.1; x5SC405.UP=0.1; x5SC406.UP=0.1;  
4537 x5SC407.UP=0.1; x5SC409.UP=0.1; x5SC411.UP=0.1;  
4538 x5SC412.UP=0.1; x5SC413.UP=0.1; x5SC414.UP=0.1;  
4539 x6SC401.UP=0.1; x6SC404.UP=0.12; x6SC405.UP=0.1;  
4540 x6SC406.UP=0.1; x6SC407.UP=0.1; x6SC409.UP=0.1;  
4541 x6SC411.UP=0.1; x6SC412.UP=0.1; x6SC413.UP=0.1;  
4542 x6SC414.UP=0.1; x7AC09.UP=0.1; x7AC20.UP=0.1;  
4543 x7AC31.UP=0.1; x7AC42.UP=0.1; x7C301.UP=0.1;  
4544 x7C302.UP=0.3; x7C303.UP=0.1; x7C306.UP=0.8;  
4545 x7C307.UP=0.8; x7C308.UP=0.3; x7C309.UP=0.3;  
4546 x7C310.UP=0.2; x7C311.UP=1; x7C312.UP=0.5;  
4547 x7C315.UP=0.01; x7C316.UP=0.01; x7C317.UP=0.1;  
4548 x7C318.UP=0.15; x7C319.UP=0.15; x7C320.UP=0.1;  
4549 x7C321.UP=0.1; x7C322.UP=0.1; x7C323.UP=0.02;  
4550 x7C324.UP=0.1; x7C325.UP=0.2; x7C326.UP=0.2;  
4551 x7C328.UP=0.2; x7C329.UP=0.1; x7C401.UP=1;  
4552 x7C402.UP=0.6; x7C403.UP=1; x7C404.UP=1;  
4553 x7C405.UP=1; x7C406.UP=1; x7C407.UP=1;  
4554 x7C408.UP=1; x7C409.UP=1; x7C410.UP=1;  
4555 x7C411.UP=1; x7C412.UP=0.2; x7C413.UP=0.3;  
4556 x7C414.UP=0.1; x7C415.UP=0.1; x7C417.UP=0.08;  
4557 x7C418.UP=0.1; x7C419.UP=0.1; x7C425.UP=1;  
4558 x7C426.UP=1; x7C427.UP=1; x7C428.UP=0.5;  
4559 x7C430.UP=0.35; x7C431.UP=0.3; x7C432.UP=0.3;  
4560 x7HC01.UP=0.6; x7HC02.UP=0.6; x7HC03.UP=0.1;  
4561 x7HC04.UP=0.25; x7HC05.UP=0.25; x7HC06.UP=0.3;  
4562 x7HC07.UP=0.3; x7HC08.UP=0.3; x7HC11.UP=0.3;

4563 x7HC14.UP=0.3; x7HC15.UP=0.3; x7HC16.UP=0.3;  
4564 x7HC22.UP=0.5; x7HC23.UP=0.5; x7HC24.UP=0.5;  
4565 x7HC25.UP=0.5; x7HC26.UP=0.5; x7HC27.UP=0.5;  
4566 x7HC28.UP=0.5; x7HC29.UP=0.5; x7HC30.UP=0.5;  
4567 x7HC31.UP=0.6; x7HC33.UP=2; x7HC34.UP=2;  
4568 x7HC38.UP=2; x7HC40.UP=2; x7HC41.UP=2;  
4569 x7HC45.UP=2; x7R1.UP=0.5; x7R29.UP=0.6;  
4570 x7SC401.UP=0.1; x7SC404.UP=0.12; x7SC405.UP=0.12;  
4571 x7SC406.UP=0.01; x7SC407.UP=0.1; x7SC409.UP=0.1;  
\_Economic Optimization Program

05/15/01 16:49:39 PAGE 104  
GAMS 2.50A Windows NT/95/98

4572 x7SC411.UP=0.1; x7SC412.UP=0.1; x7SC413.UP=0.1;  
4573 x7SC414.UP=0.1; x8AC09.UP=0.1; x8AC20.UP=0.1;  
4574 x8AC31.UP=0.1; x8AC42.UP=0.1; x9AC09.UP=0.3;  
4575 x9AC20.UP=0.3; x9AC31.UP=0.3; x9AC42.UP=0.3;  
4576 xAC02.UP=1; xAC05.UP=1; xAC07.UP=1;  
4577 xAC09.UP=1; xAC12.UP=1; xAC15.UP=1;  
4578 xAC18.UP=1; xAC20.UP=1; xAC23.UP=1;  
4579 xAC26.UP=1; xAC29.UP=1; xAC31.UP=1;  
4580 xAC34.UP=1; xAC37.UP=1; xAC40.UP=1;  
4581 xAC42.UP=1; xiC10AC09.UP=1; xiC10AC20.UP=1;  
4582 xiC10AC31.UP=1; xiC10AC42.UP=1; xiC11AC09.UP=1;  
4583 xiC11AC20.UP=1; xiC11AC31.UP=1; xiC11AC42.UP=1;  
4584 xM1C606D.UP=0.5; xM3C606D.UP=0.5; xM4C606D.UP=0.65;  
4585 xM5C606D.UP=0.5; xM7C606D.UP=1; xx1C302.UP=0.25;  
4586 xx1C308.UP=0.5; xx1C310.UP=0.5; xx1C311.UP=0.3;  
4587 xx1C312.UP=1; xx1C323.UP=0.2; xx1C325.UP=1;  
4588 xx1C405.UP=0.01; xx1C408.UP=1; xx1C425.UP=1;  
4589 xx1C428.UP=1; xx1C430.UP=0.5; xx1C431.UP=0.1;  
4590 xx1HC28.UP=0.2; xx1HC29.UP=0.2; xx1HC30.UP=0.2;  
4591 xx1HC32.UP=0.1; xx1R1.UP=0.2; xx1R29.UP=0.1;  
4592 xx1SC406.UP=0.2; xx1SC408.UP=0.1; xx2HC28.UP=0.1;  
4593 xx2HC29.UP=0.1; xx2HC30.UP=0.1; xx2R1.UP=0.1;  
4594 xx2R29.UP=0.1; xx2SC406.UP=0.1; xx2SC408.UP=1;  
4595 xx3C302.UP=1; xx3C308.UP=1; xx3C310.UP=1;  
4596 xx3C311.UP=1; xx3C312.UP=1; xx3C323.UP=0.92;  
4597 xx3C325.UP=0.5; xx3C405.UP=0.1; xx3C408.UP=1;  
4598 xx3C425.UP=1; xx3C428.UP=1; xx3C430.UP=0.1;  
4599 xx3C431.UP=0.5; xx3C432.UP=0.15; xx3HC28.UP=0.8;  
4600 xx3HC29.UP=0.8; xx3HC30.UP=0.6; xx3HC32.UP=1;  
4601 xx3R1.UP=0.8; xx3R29.UP=0.6; xx3SC406.UP=0.1;  
4602 xx3SC408.UP=1; xx4C302.UP=0.5; xx4C308.UP=0.5;  
4603 xx4C310.UP=0.3; xx4C311.UP=0.5; xx4C312.UP=0.15;  
4604 xx4C323.UP=0.28; xx4C325.UP=0.05; xx4C405.UP=0.2;  
4605 xx4C408.UP=0.3; xx4C409.UP=0.3; xx4C425.UP=1;  
4606 xx4C427.UP=1; xx4C428.UP=1; xx4C430.UP=1;  
4607 xx4C431.UP=1; xx4C432.UP=1; xx4HC28.UP=0.3;  
4608 xx4HC29.UP=0.3; xx4HC30.UP=0.3; xx4HC32.UP=0.5;  
4609 xx4R1.UP=0.3; xx4R29.UP=0.3; xx4SC406.UP=1;  
4610 xx4SC408.UP=0.05; xx5C302.UP=0.1; xx5C308.UP=0.8;  
4611 xx5C310.UP=0.1; xx5C311.UP=0.1; xx5C312.UP=0.3;  
4612 xx5C323.UP=0.15; xx5C325.UP=0.001; xx5C405.UP=0.2;  
4613 xx5C408.UP=0.3; xx5C425.UP=1; xx5C428.UP=1;  
4614 xx5C430.UP=1; xx5C431.UP=1; xx5HC28.UP=0.3;  
4615 xx5HC29.UP=0.3; xx5HC30.UP=0.3; xx5HC32.UP=0.2;  
4616 xx5R1.UP=0.3; xx5R29.UP=0.3; xx5SC406.UP=0.15;  
4617 xx5SC408.UP=0.1; xx6SC406.UP=0.1; xx6SC408.UP=1;  
\_Economic Optimization Program

05/15/01 16:49:39 PAGE 105  
GAMS 2.50A Windows NT/95/98

4618 xx7C302.UP=0.2; xx7C308.UP=0.1; xx7C310.UP=0.1;  
4619 xx7C311.UP=0.3; xx7C312.UP=0.1; xx7C323.UP=0.1;  
4620 xx7C325.UP=0.1; xx7C405.UP=1; xx7C408.UP=1;  
4621 xx7C425.UP=1; xx7C428.UP=1; xx7C430.UP=1;  
4622 xx7C431.UP=1; xx7HC28.UP=0.4; xx7HC29.UP=0.5;  
4623 xx7HC30.UP=0.5; xx7HC32.UP=0.2; xx7R1.UP=0.5;  
4624 xx7R29.UP=0.5; xx7SC406.UP=0.1; xx7SC408.UP=0.1;  
4625 y1HC28.UP=0.5; y1HC29.UP=0.5; y1HC30.UP=0.5;  
4626 y1HC31.UP=0.4; y1R1.UP=0.5; y1R29.UP=0.5;  
4627 y2HC28.UP=0.1; y2HC29.UP=0.1; y2HC30.UP=0.1;  
4628 y2HC31.UP=0.1; y2R1.UP=0.1; y2R29.UP=0.1;  
4629 y3HC28.UP=0.9; y3HC29.UP=0.9; y3HC30.UP=0.85;  
4630 y3HC31.UP=0.85; y3R1.UP=0.9; y3R29.UP=0.85;  
4631 y4HC28.UP=0.5; y4HC29.UP=0.3; y4HC30.UP=0.4;  
4632 y4HC31.UP=0.3; y4R1.UP=0.3; y4R29.UP=0.5;  
4633 y5HC28.UP=0.2; y5HC29.UP=0.2; y5HC30.UP=0.2;  
4634 y5HC31.UP=0.2; y5R1.UP=0.2; y5R29.UP=0.2;  
4635 y7HC28.UP=0.5; y7HC29.UP=0.1; y7HC30.UP=0.1;  
4636 y7HC31.UP=0.2; y7R1.UP=0.1; y7R29.UP=0.2;  
4637 yy1HC28.UP=0.5; yy1HC29.UP=0.6; yy1HC30.UP=0.6;  
4638 yy1R1.UP=0.6; yy1R29.UP=0.6; yy2HC28.UP=0.1;  
4639 yy2HC29.UP=0.1; yy2HC30.UP=0.1; yy2R1.UP=0.1;  
4640 yy2R29.UP=0.1; yy3HC28.UP=0.9; yy3HC29.UP=0.8;  
4641 yy3HC30.UP=0.8; yy3R1.UP=0.8; yy3R29.UP=0.8;  
4642 yy4HC28.UP=0.3; yy4HC29.UP=0.3; yy4HC30.UP=0.3;  
4643 yy4R1.UP=0.3; yy4R29.UP=0.3; yy5HC28.UP=0.2;  
4644 yy5HC29.UP=0.2; yy5HC30.UP=0.1; yy5R1.UP=0.2;  
4645 yy5R29.UP=0.2; yy7HC28.UP=0.2; yy7HC29.UP=0.2;  
4646 yy7HC30.UP=0.1; yy7R1.UP=0.1; yy7R29.UP=0.2;

```

4647
4648 MODEL Alkyl /ALL/;
4649 OPTION LIMCOL=0;
4650 OPTION LIMROW=0;
4651 OPTION ITERLIM= 10000;
4652 OPTION DOMLIM= 0;
4653 OPTION RESLIM= 10000;
4654
4655 OPTION NLP=CONOPT2;
4656 SOLVE Alkyl Using NLP Maximizing ObjVar;
4657

```

```

COMPILATION TIME = 0.660 SECONDS 1.6 Mb WIN-18-097
_Economic Optimization Program
Model Statistics SOLVE ALKYL USING NLP FROM LINE 4656

```

```

05/15/01 16:49:39 PAGE 106
GAMS 2.50A Windows NT/95/98

```

MODEL STATISTICS

```

BLOCKS OF EQUATIONS 1630 SINGLE EQUATIONS 1630
BLOCKS OF VARIABLES 1635 SINGLE VARIABLES 1635
NON ZERO ELEMENTS 6592 NON LINEAR N-Z 4104
DERIVATIVE POOL 17 CONSTANT POOL 199
CODE LENGTH 74192

```

```

GENERATION TIME = 0.550 SECONDS 3.0 Mb WIN-18-097

```

```

EXECUTION TIME = 0.710 SECONDS 2.9 Mb WIN-18-097
_Economic Optimization Program

```

```

05/15/01 16:49:39 PAGE 107
GAMS 2.50A Windows NT/95/98

```

S O L V E S U M M A R Y

```

MODEL ALKYL OBJECTIVE OBJVAR
TYPE NLP DIRECTION MAXIMIZE
SOLVER CONOPT2 FROM LINE 4656

```

```

**** SOLVER STATUS 1 NORMAL COMPLETION
**** MODEL STATUS 2 LOCALLY OPTIMAL
**** OBJECTIVE VALUE 29.1128

```

```

RESOURCE USAGE, LIMIT 9.949 10000.000
ITERATION COUNT, LIMIT 63 10000
EVALUATION ERRORS 0 0

```

```

C O N O P T Wintel version 2.070F-003-035
Copyright (C) ARK1 Consulting and Development A/S
Bagsvaerdvej 246 A
DK-2880 Bagsvaerd, Denmark

```

Using control program file C:\PROGRAM FILES\GAMSIDE\CONOPT2.OPT

```

Rtmaxj=1E9;
rtnwmi=1E-8;
*rtredg=1E-9;
*lslack =t;
lsscal= t;
*lstcrs =t;
lfstal =2000;

```

```

** Warning ** Rtmaxj is very large. Try to scale the model.
CONOPT may become unreliable and there are no
guaranties.

```

\*\* Optimal solution. Reduced gradient less than tolerance.

```

CONOPT time Total 9.512 seconds
of which: Function evaluations 1.926 = 20.2%
Derivative evaluations 0.762 = 8.0%

```

```

Work length = 3.45 Mbytes
Estimate = 3.45 Mbytes
Max used = 1.93 Mbytes
_Economic Optimization Program

```

```

05/15/01 16:49:39 PAGE 108
GAMS 2.50A Windows NT/95/98

```

	LOWER	LEVEL	UPPER	MARGINAL
---- EQU EQU1	.	.	.	.
---- EQU EQU2	.	.	.	739.4425
---- EQU EQU3	.	.	.	0.0235
---- EQU EQU4	.	.	.	-10.5486

----	EQU EQU5	.	.	.	-31.4441	
----	EQU EQU6	.	.	.	0.8396	
----	EQU EQU7	.	.	.	0.1236	
----	EQU EQU8	.	.	.	-0.7526	
----	EQU EQU9	.	.	.	0.2006	
----	EQU EQU10	.	.	.	0.0024	
----	EQU EQU11	1.0000	1.0000	1.0000	4.1594	
----	EQU EQU12	.	.	.	EPS	
----	EQU EQU13	.	.	.	EPS	
----	EQU EQU14	460.0000	460.0000	460.0000	-0.0015	
----	EQU EQU15	.	.	.	0.0003	
----	EQU EQU16	.	.	.	EPS	
----	EQU EQU17	.	.	.	1145.6702	
----	EQU EQU18	-70.0000	-70.0000	-70.0000	-0.0004	
----	EQU EQU19	.	.	.	EPS	
----	EQU EQU20	1.0000	1.0000	1.0000	71.4458	
----	EQU EQU21	.	.	.	-0.7449	
----	EQU EQU22	.	.	.	EPS	
----	EQU EQU23	.	.	.	-0.0002	
----	EQU EQU24	.	.	.	118.6951	
----	EQU EQU25	.	.	.	118.1386	
----	EQU EQU26	.	.	.	-0.0002	
----	EQU EQU27	.	.	.	-0.0490	
----	EQU EQU28	.	.	.	-0.0001	
----	EQU EQU29	.	.	.	0.0029	
----	EQU EQU30	.	.	.	-0.0497	
----	EQU EQU31	.	.	.	EPS	
----	EQU EQU32	.	.	.	0.0004	
----	EQU EQU33	.	.	.	-275.6855	
----	EQU EQU34	.	.	.	8.0277	
----	EQU EQU35	.	.	.	8.4063	
----	EQU EQU36	.	.	.	0.0232	
----	EQU EQU37	.	.	.	-115.8303	
----	EQU EQU38	.	.	.	-82.6546	
----	EQU EQU39	.	.	.	-64.7196	
----	EQU EQU40	.	.	.	11.9525	
----	EQU EQU41	.	.	.	EPS	
----	EQU EQU42	1.0000	1.0000	1.0000	-4.8177	
----	EQU EQU43	1.0000	1.0000	1.0000	480.6352	
----	EQU EQU44	1.0000	1.0000	1.0000	-6.6694	

\_Economic Optimization Program

05/15/01 16:49:39 PAGE 109  
GAMS 2.50A Windows NT/95/98

	LOWER	LEVEL	UPPER	MARGINAL	
----	EQU EQU45	1.0000	1.0000	1.0000	0.6527
----	EQU EQU46	1.0000	1.0000	1.0000	EPS
----	EQU EQU47	1.0000	1.0000	1.0000	-187.9903
----	EQU EQU48	1.0000	1.0000	1.0000	195.0964
----	EQU EQU49	1.0000	1.0000	1.0000	1.5425
----	EQU EQU50	1.0000	1.0000	1.0000	-0.2369
----	EQU EQU51	1.0000	1.0000	1.0000	57.5949
----	EQU EQU52	1.0000	1.0000	1.0000	-53.6290
----	EQU EQU53	1.0000	1.0000	1.0000	-599.6805
----	EQU EQU54	1.0000	1.0000	1.0000	-2.4033
----	EQU EQU55	1.0000	1.0000	1.0000	38.1402
----	EQU EQU56	1.0000	1.0000	1.0000	-0.6670
----	EQU EQU57	1.0000	1.0000	1.0000	-0.5897
----	EQU EQU58	1.0000	1.0000	1.0000	-1.4836
----	EQU EQU59	1.0000	1.0000	1.0000	EPS
----	EQU EQU60	1.0000	1.0000	1.0000	.
----	EQU EQU61	1.0000	1.0000	1.0000	-4.1130
----	EQU EQU62	1.0000	1.0000	1.0000	-0.4251
----	EQU EQU63	1.0000	1.0000	1.0000	1.0731
----	EQU EQU64	1.0000	1.0000	1.0000	88.6032
----	EQU EQU65	1.0000	1.0000	1.0000	47.1447
----	EQU EQU66	1.0000	1.0000	1.0000	1.9278
----	EQU EQU67	1.0000	1.0000	1.0000	283.4007
----	EQU EQU68	1.0000	1.0000	1.0000	.
----	EQU EQU69	1.0000	1.0000	1.0000	-1.5441
----	EQU EQU70	1.0000	1.0000	1.0000	EPS
----	EQU EQU71	1.0000	1.0000	1.0000	EPS
----	EQU EQU72	1.0000	1.0000	1.0000	-0.1797
----	EQU EQU73	1.0000	1.0000	1.0000	268.1690
----	EQU EQU74	1.0000	1.0000	1.0000	-290.7238
----	EQU EQU75	1.0000	1.0000	1.0000	25.2985
----	EQU EQU76	.	.	.	EPS
----	EQU EQU77	.	.	.	EPS
----	EQU EQU78	.	.	.	0.0093
----	EQU EQU79	.	.	.	-0.0083
----	EQU EQU80	.	.	.	0.0009
----	EQU EQU81	.	.	.	0.0124
----	EQU EQU82	.	.	.	0.0005
----	EQU EQU83	.	.	.	-0.0056
----	EQU EQU84	.	.	.	EPS
----	EQU EQU85	.	.	.	0.8074
----	EQU EQU86	.	.	.	EPS
----	EQU EQU87	.	.	.	0.0129
----	EQU EQU88	.	.	.	EPS

\_Economic Optimization Program

05/15/01 16:49:39 PAGE 110  
GAMS 2.50A Windows NT/95/98



	LOWER	LEVEL	UPPER	MARGINAL
---- EQU EQU89	.	.	.	0.0037
---- EQU EQU90	.	.	.	-6.1941
---- EQU EQU91	.	.	.	214.4071
---- EQU EQU92	.	.	.	0.5261
---- EQU EQU93	.	.	.	113.2581
---- EQU EQU94	.	.	.	710.4108
---- EQU EQU95	.	.	.	113.4234
---- EQU EQU96	.	.	.	113.5545
---- EQU EQU97	.	.	.	1.3817
---- EQU EQU98	.	.	.	118.3296
---- EQU EQU99	.	.	.	744.3364
---- EQU EQU100	.	.	.	118.6955
---- EQU EQU101	.	.	.	118.9888
---- EQU EQU102	.	.	.	EPS
---- EQU EQU103	.	.	.	-0.8074
---- EQU EQU104	.	.	.	0.0173
---- EQU EQU105	.	.	.	0.0005
---- EQU EQU106	.	.	.	0.0003
---- EQU EQU107	.	.	.	3.2816042E-7
---- EQU EQU108	.	.	.	EPS
---- EQU EQU109	.	.	.	EPS
---- EQU EQU110	.	.	.	EPS
---- EQU EQU111	.	.	.	EPS
---- EQU EQU112	.	.	.	EPS
---- EQU EQU113	.	.	.	EPS
---- EQU EQU114	.	.	.	EPS
---- EQU EQU115	.	.	.	1.4959
---- EQU EQU116	.	.	.	0.3785
---- EQU EQU117	.	.	.	0.0007
---- EQU EQU118	.	.	.	7.1057781E-6
---- EQU EQU119	.	.	.	EPS
---- EQU EQU120	.	.	.	EPS
---- EQU EQU121	.	.	.	EPS
---- EQU EQU122	.	.	.	EPS
---- EQU EQU123	.	.	.	-0.0007
---- EQU EQU124	.	.	.	EPS
---- EQU EQU125	.	.	.	-0.0074
---- EQU EQU126	.	.	.	0.0005
---- EQU EQU127	.	.	.	-0.0330
---- EQU EQU128	.	.	.	-142.8070
---- EQU EQU129	.	.	.	-194.9739
---- EQU EQU130	.	.	.	0.0536
---- EQU EQU131	.	.	.	EPS
---- EQU EQU132	.	.	.	EPS

\_Economic Optimization Program

05/15/01 16:49:39 PAGE 111  
GAMS 2.50A Windows NT/95/98

	LOWER	LEVEL	UPPER	MARGINAL
---- EQU EQU133	.	.	.	EPS
---- EQU EQU134	.	.	.	EPS
---- EQU EQU135	.	.	.	EPS
---- EQU EQU136	.	.	.	EPS
---- EQU EQU137	0.1500	0.1500	0.1500	0.1337
---- EQU EQU138	15.0000	15.0000	15.0000	-29.4541
---- EQU EQU139	15.0000	15.0000	15.0000	1.1390
---- EQU EQU140	15.0000	15.0000	15.0000	0.1338
---- EQU EQU141	15.0000	15.0000	15.0000	0.0660
---- EQU EQU142	.	.	.	10.0266
---- EQU EQU143	.	.	.	152.9267
---- EQU EQU144	.	.	.	-67.1301
---- EQU EQU145	.	.	.	-170.0790
---- EQU EQU146	.	.	.	-163.4739
---- EQU EQU147	.	.	.	-0.8182
---- EQU EQU148	.	.	.	5.1171800E-5
---- EQU EQU149	.	.	.	EPS
---- EQU EQU150	.	.	.	EPS
---- EQU EQU151	.	.	.	EPS
---- EQU EQU152	.	.	.	-0.0003
---- EQU EQU153	.	.	.	-0.0019
---- EQU EQU154	.	.	.	-0.0002
---- EQU EQU155	.	.	.	-1.099730E-5
---- EQU EQU156	.	.	.	-5.322803E-6
---- EQU EQU157	1.0000	1.0000	1.0000	4.0764
---- EQU EQU158	.	.	.	253.2285
---- EQU EQU159	.	.	.	-12.5082
---- EQU EQU160	.	.	.	-3.8347
---- EQU EQU161	.	.	.	-2.7680
---- EQU EQU162	.	.	.	-0.7577
---- EQU EQU163	1.0000	1.0000	1.0000	-0.4944
---- EQU EQU164	-290.0000	-290.0000	-290.0000	-0.0409
---- EQU EQU165	.	.	.	-115.8303
---- EQU EQU166	.	.	.	-82.6546
---- EQU EQU167	.	.	.	-64.7196
---- EQU EQU168	.	.	.	201.1220
---- EQU EQU169	.	.	.	-0.0027
---- EQU EQU170	.	.	.	0.0011

```

---- EQU EQU171 . . . EPS
---- EQU EQU172 . . . EPS
---- EQU EQU173 . . . 0.9789
---- EQU EQU174 . . . EPS
---- EQU EQU175 . . . 25.7544
---- EQU EQU176 . . . 349.7236

```

\_Economic Optimization Program

05/15/01 16:49:39 PAGE 112  
GAMS 2.50A Windows NT/95/98

	LOWER	LEVEL	UPPER	MARGINAL
---- EQU EQU177	.	.	.	18.0425
---- EQU EQU178	.	.	.	14.8017
---- EQU EQU179	.	.	.	-0.1213
---- EQU EQU180	.	.	.	11.9525
---- EQU EQU181	1.0000	1.0000	1.0000	-2.5433
---- EQU EQU182	1.0000	1.0000	1.0000	.
---- EQU EQU183	.	.	.	0.0585
---- EQU EQU184	.	.	.	EPS
---- EQU EQU185	.	.	.	EPS
---- EQU EQU186	.	.	.	EPS
---- EQU EQU187	.	.	.	EPS
---- EQU EQU188	.	.	.	EPS
---- EQU EQU189	.	.	.	0.0012
---- EQU EQU190	.	.	.	EPS
---- EQU EQU191	.	.	.	EPS
---- EQU EQU192	.	.	.	EPS
---- EQU EQU193	.	.	.	EPS
---- EQU EQU194	1.0000	1.0000	1.0000	1.9812
---- EQU EQU195	.	.	.	-853.0956
---- EQU EQU196	.	.	.	19.3446
---- EQU EQU197	.	.	.	11.9384
---- EQU EQU198	.	.	.	10.1690
---- EQU EQU199	.	.	.	0.9104
---- EQU EQU200	1.0000	1.0000	1.0000	-17.8060
---- EQU EQU201	.	.	.	-0.0002
---- EQU EQU202	.	.	.	-4391.9189
---- EQU EQU203	.	.	.	4.1086
---- EQU EQU204	.	.	.	4.1086
---- EQU EQU205	.	.	.	3909.3001
---- EQU EQU206	.	.	.	4.1094
---- EQU EQU207	.	.	.	4.1089
---- EQU EQU208	.	.	.	4.1089
---- EQU EQU209	.	.	.	-4.1089
---- EQU EQU210	.	.	.	-147.6805
---- EQU EQU211	.	.	.	EPS
---- EQU EQU212	.	.	.	EPS
---- EQU EQU213	.	.	.	-4.0709
---- EQU EQU214	.	.	.	-4.0710
---- EQU EQU215	.	.	.	-3.8716
---- EQU EQU216	.	.	.	-4070.9701
---- EQU EQU217	.	.	.	11551.6039
---- EQU EQU218	.	.	.	14178.9548
---- EQU EQU219	.	.	.	16975.8098
---- EQU EQU220	.	.	.	22279.5462

\_Economic Optimization Program

05/15/01 16:49:39 PAGE 113  
GAMS 2.50A Windows NT/95/98

	LOWER	LEVEL	UPPER	MARGINAL
---- EQU EQU221	.	.	.	24934.4914
---- EQU EQU222	.	.	.	27543.6260
---- EQU EQU223	.	.	.	19627.6738
---- EQU EQU224	.	.	.	30195.3153
---- EQU EQU225	.	.	.	-647.9201
---- EQU EQU226	.	.	.	-4.3720
---- EQU EQU227	.	.	.	11306.9948
---- EQU EQU228	.	.	.	-11262.3527
---- EQU EQU229	.	.	.	-14160.3290
---- EQU EQU230	.	.	.	-22752.7269
---- EQU EQU231	.	.	.	-11551.6039
---- EQU EQU232	.	.	.	-11017.6385
---- EQU EQU233	.	.	.	-14178.9548
---- EQU EQU234	.	.	.	-16973.8419
---- EQU EQU235	.	.	.	77.6883
---- EQU EQU236	.	.	.	-0.0011
---- EQU EQU237	.	.	.	0.0274
---- EQU EQU238	.	.	.	-161.2654
---- EQU EQU239	.	.	.	-197.0497
---- EQU EQU240	.	.	.	38.0952
---- EQU EQU241	.	.	.	-161.2639
---- EQU EQU242	.	.	.	-161.2624
---- EQU EQU243	.	.	.	-704.6349
---- EQU EQU244	.	.	.	139.9478
---- EQU EQU245	.	.	.	-4353.5409
---- EQU EQU246	.	.	.	-345.8274
---- EQU EQU247	.	.	.	-199.1877
---- EQU EQU248	1.0000	1.0000	1.0000	EPS
---- EQU EQU249	.	.	.	-0.2353
---- EQU EQU250	.	.	.	EPS

```

---- EQU EQU251      .      .      .      -199.1939
---- EQU EQU252      .      .      .      43.1651
---- EQU EQU253      .      .      .      237.0142
---- EQU EQU254      .      .      .      38.0387
---- EQU EQU255      .      .      .      37.8675
---- EQU EQU256      .      .      .      1.4679
---- EQU EQU257      .      .      .      1.8240
---- EQU EQU258      .      .      .      0.3662
---- EQU EQU259      1.0000  1.0000  1.0000  -34655.3030
---- EQU EQU260      .      .      .      -3909.3001
---- EQU EQU261      .      .      .      4391.9189
---- EQU EQU262      1.0000  1.0000  1.0000  30152.2623
---- EQU EQU263      1.0000  1.0000  1.0000  EPS
---- EQU EQU264      .      .      .      -19610.0364

```

\_Economic Optimization Program

05/15/01 16:49:39 PAGE 114  
GAMS 2.50A Windows NT/95/98

```

          LOWER      LEVEL      UPPER      MARGINAL
---- EQU EQU265      .      .      .      -22279.9911
---- EQU EQU266      .      .      .      -24934.4914
---- EQU EQU267      .      .      .      -27543.6260
---- EQU EQU268      .      .      .      -30208.5612
---- EQU EQU269      .      .      .      EPS
---- EQU EQU270      .      .      .      -0.0191
---- EQU EQU271      414.6000  414.6000  414.6000  -0.1133
---- EQU EQU272      .      .      .      -0.0002
---- EQU EQU273      .      .      .      0.0007
---- EQU EQU274      .      .      .      -0.2783
---- EQU EQU275      .      .      .      0.0206
---- EQU EQU276      .      .      .      -1.4778
---- EQU EQU277      .      .      .      -0.0002
---- EQU EQU278      .      .      .      0.0007
---- EQU EQU279      1.0000  1.0000  1.0000  EPS
---- EQU EQU280      .      .      .      -3920.2789
---- EQU EQU281      .      .      .      4404.2166
---- EQU EQU282      1.0000  1.0000  1.0000  35904.5185
---- EQU EQU283      1.0000  1.0000  1.0000  EPS
---- EQU EQU284      .      .      .      -4.1200
---- EQU EQU285      .      .      .      25002.6937
---- EQU EQU286      .      .      .      22339.1337
---- EQU EQU287      .      .      .      17021.0679
---- EQU EQU288      .      .      .      14217.0026
---- EQU EQU289      .      .      .      -0.1413
---- EQU EQU290      .      .      .      129.9365
---- EQU EQU291      .      .      .      -0.5838
---- EQU EQU292      .      .      .      -2.5624
---- EQU EQU293      .      .      .      -1.8140
---- EQU EQU294      .      .      .      -1.9706
---- EQU EQU295      1.0000  1.0000  1.0000  1.8240
---- EQU EQU296      .      .      .      -2.3847
---- EQU EQU297      .      .      .      -2.2866
---- EQU EQU298      .      .      .      0.1549
---- EQU EQU299      .      .      .      -0.0544
---- EQU EQU300      .      .      .      0.0532
---- EQU EQU301      1.0000  1.0000  1.0000  -0.1219
---- EQU EQU302      .      .      .      -44.0126
---- EQU EQU303      .      .      .      -235.1783
---- EQU EQU304      .      .      .      -36.9474
---- EQU EQU305      .      .      .      -36.1915
---- EQU EQU306      .      .      .      11582.5038
---- EQU EQU307      .      .      .      -4082.0793
---- EQU EQU308      .      .      .      -3.8827

```

\_Economic Optimization Program

05/15/01 16:49:39 PAGE 115  
GAMS 2.50A Windows NT/95/98

```

          LOWER      LEVEL      UPPER      MARGINAL
---- EQU EQU309      .      .      .      -4404.2166
---- EQU EQU310      .      .      .      -4.0820
---- EQU EQU311      .      .      .      30275.3750
---- EQU EQU312      .      .      .      4.1200
---- EQU EQU313      .      .      .      4.1200
---- EQU EQU314      .      .      .      4.1207
---- EQU EQU315      .      .      .      3920.2789
---- EQU EQU316      .      .      .      4.1196
---- EQU EQU317      .      .      .      4.1196
---- EQU EQU318      .      .      .      -4.0821
---- EQU EQU319      .      .      .      -11048.5343
---- EQU EQU320      .      .      .      -27616.6053
---- EQU EQU321      .      .      .      -25002.6937
---- EQU EQU322      .      .      .      -22339.8242
---- EQU EQU323      .      .      .      -19655.1392
---- EQU EQU324      .      .      .      0.0248
---- EQU EQU325      .      .      .      -0.0023
---- EQU EQU326      .      .      .      87.8220
---- EQU EQU327      .      .      .      27616.6053
---- EQU EQU328      .      .      .      -14217.0026
---- EQU EQU329      .      .      .      19680.0947
---- EQU EQU330      .      .      .      -11582.5038

```

```

---- EQU EQU331 . . . -22806.4593
---- EQU EQU332 . . . -14199.8544
---- EQU EQU333 . . . -11291.2898
---- EQU EQU334 . . . 11339.8148
---- EQU EQU335 . . . -4.3847
---- EQU EQU336 . . . -649.0836
---- EQU EQU337 . . . -30296.1156
---- EQU EQU338 . . . -17018.2290
---- EQU EQU339 1.0000 1.0000 1.0000 EPS
---- EQU EQU340 . . . -197.7392
---- EQU EQU341 . . . 44.0126
---- EQU EQU342 . . . 235.1783
---- EQU EQU343 . . . 36.9474
---- EQU EQU344 . . . 36.1915
---- EQU EQU345 1.0000 1.0000 1.0000 -39032.9400
---- EQU EQU346 . . . -199.1877
---- EQU EQU347 . . . -231.0785
---- EQU EQU348 . . . -4229.7093
---- EQU EQU349 . . . 257.6077
---- EQU EQU350 . . . -706.9530
---- EQU EQU351 . . . -161.2624
---- EQU EQU352 . . . -161.2639

```

\_Economic Optimization Program

05/15/01 16:49:39 PAGE 116  
GAMS 2.50A Windows NT/95/98

```

          LOWER      LEVEL      UPPER      MARGINAL
---- EQU EQU353 . . . 38.0952
---- EQU EQU354 . . . -197.0497
---- EQU EQU355 . . . -161.2654
---- EQU EQU356 . . . -4.883566E-6
---- EQU EQU357 . . . EPS
---- EQU EQU358 . . . 2.3789940E-5
---- EQU EQU359 1.0000 1.0000 1.0000 EPS
---- EQU EQU360 1.0000 1.0000 1.0000 EPS
---- EQU EQU361 1.0000 1.0000 1.0000 74557.3811
---- EQU EQU362 1.0000 1.0000 1.0000 -78323.0110
---- EQU EQU363 . . . EPS
---- EQU EQU364 . . . EPS
---- EQU EQU365 1.0000 1.0000 1.0000 4132.5959
---- EQU EQU366 . . . EPS
---- EQU EQU367 1.0000 1.0000 1.0000 2067.0435
---- EQU EQU368 . . . -3933.3380
---- EQU EQU369 . . . 4418.8414
---- EQU EQU370 . . . -161.2654
---- EQU EQU371 . . . -197.0497
---- EQU EQU372 . . . 38.0952
---- EQU EQU373 . . . -161.2639
---- EQU EQU374 . . . 2.4490
---- EQU EQU375 . . . 71.4458
---- EQU EQU376 . . . 2.2677
---- EQU EQU377 . . . -1.2644
---- EQU EQU378 . . . 0.0011
---- EQU EQU379 . . . EPS
---- EQU EQU380 . . . 2285.2246
---- EQU EQU381 . . . -50.1414
---- EQU EQU382 . . . -39.8209
---- EQU EQU383 . . . -38.1591
---- EQU EQU384 . . . -32.3196
---- EQU EQU385 . . . -133.6911
---- EQU EQU386 . . . 0.6200
---- EQU EQU387 . . . 2.5785
---- EQU EQU388 . . . 1.8350
---- EQU EQU389 . . . 1.9784
---- EQU EQU390 1.0000 1.0000 1.0000 -7.3263
---- EQU EQU391 . . . 197.7392
---- EQU EQU392 . . . 1.4860127E-6
---- EQU EQU393 . . . 1.4860127E-6
---- EQU EQU394 . . . EPS
---- EQU EQU395 . . . 179.9891
---- EQU EQU396 . . . 176.3066

```

\_Economic Optimization Program

05/15/01 16:49:39 PAGE 117  
GAMS 2.50A Windows NT/95/98

```

          LOWER      LEVEL      UPPER      MARGINAL
---- EQU EQU397 . . . -4.0202
---- EQU EQU398 . . . 33.6907
---- EQU EQU399 . . . -2.8400
---- EQU EQU400 . . . 33.9158
---- EQU EQU401 . . . 364.8746
---- EQU EQU402 -20.0000 -20.0000 -20.0000 EPS
---- EQU EQU403 . . . -3.350189E-7
---- EQU EQU404 . . . -0.0683
---- EQU EQU405 . . . -194.2702
---- EQU EQU406 . . . EPS
---- EQU EQU407 . . . -172.9634
---- EQU EQU408 . . . 364.7427
---- EQU EQU409 . . . 20.3835
---- EQU EQU410 . . . 15.8714

```

----	EQU	EQU411	.	.	.	-161.2624
----	EQU	EQU412	.	.	.	-710.9957
----	EQU	EQU413	.	.	.	372.7427
----	EQU	EQU414	.	.	.	-4084.8949
----	EQU	EQU415	.	.	.	-115.9677
----	EQU	EQU416	.	.	.	-199.1877
----	EQU	EQU417	.	.	.	-4418.8414
----	EQU	EQU418	.	.	.	-4.1332
----	EQU	EQU419	.	.	.	4.1326
----	EQU	EQU420	.	.	.	4.1326
----	EQU	EQU421	.	.	.	3933.3380
----	EQU	EQU422	.	.	.	4.1342
----	EQU	EQU423	.	.	.	4.1332
----	EQU	EQU424	.	.	.	4.1332
----	EQU	EQU425	.	.	.	-11083.5953
----	EQU	EQU426	.	.	.	-4.0952
----	EQU	EQU427	.	.	.	-27701.7091
----	EQU	EQU428	.	.	.	-3.8959
----	EQU	EQU429	.	.	.	-4095.2949
----	EQU	EQU430	.	.	.	11617.5659
----	EQU	EQU431	.	.	.	14260.5673
----	EQU	EQU432	.	.	.	17073.2101
----	EQU	EQU433	.	.	.	22408.3222
----	EQU	EQU434	.	.	.	25082.1568
----	EQU	EQU435	.	.	.	30368.9002
----	EQU	EQU436	.	.	.	-14260.5673
----	EQU	EQU437	.	.	.	-30403.8032
----	EQU	EQU438	.	.	.	-648.7712
----	EQU	EQU439	.	.	.	-4.3984
----	EQU	EQU440	.	.	.	11375.1857

\_Economic Optimization Program

05/15/01 16:49:39 PAGE 118  
GAMS 2.50A Windows NT/95/98

	LOWER	LEVEL	UPPER	MARGINAL		
----	EQU	EQU441	.	.	.	-11325.8672
----	EQU	EQU442	.	.	.	-14243.7742
----	EQU	EQU443	.	.	.	-22860.7113
----	EQU	EQU444	.	.	.	-4.0953
----	EQU	EQU445	.	.	.	19740.7576
----	EQU	EQU446	.	.	.	-17068.4476
----	EQU	EQU447	.	.	.	27701.7091
----	EQU	EQU448	.	.	.	176.0509
----	EQU	EQU449	.	.	.	-0.0062
----	EQU	EQU450	.	.	.	0.0243
----	EQU	EQU451	.	.	.	-19700.5325
----	EQU	EQU452	.	.	.	-22409.4625
----	EQU	EQU453	.	.	.	20.4920
----	EQU	EQU454	.	.	.	15.8856
----	EQU	EQU455	.	.	.	25.9485
----	EQU	EQU456	.	.	.	349.8365
----	EQU	EQU457	.	.	.	18.1369
----	EQU	EQU458	.	.	.	14.8149
----	EQU	EQU459	.	.	.	-1.2718
----	EQU	EQU460	.	.	.	14.4140
----	EQU	EQU461	.	.	.	.
----	EQU	EQU462	.	.	.	.
----	EQU	EQU463	.	.	.	.
----	EQU	EQU464	.	.	.	EPS
----	EQU	EQU465	.	.	.	-0.6613
----	EQU	EQU466	.	.	.	EPS
----	EQU	EQU467	.	.	.	EPS
----	EQU	EQU468	.	.	.	-25082.1568
----	EQU	EQU469	.	.	.	-11617.5659
----	EQU	EQU470	1.0000	1.0000	1.0000	-295.6086
----	EQU	EQU471	1.0000	1.0000	1.0000	EPS
----	EQU	EQU472	1.0000	1.0000	1.0000	-293.5564
----	EQU	EQU473	1.0000	1.0000	1.0000	58924.7749
----	EQU	EQU474	1.0000	1.0000	1.0000	EPS
----	EQU	EQU475	1.0000	1.0000	1.0000	-64821.9262
----	EQU	EQU476	1.0000	1.0000	1.0000	EPS
----	EQU	EQU477	.	.	.	EPS
----	EQU	EQU478	.	.	.	EPS
----	EQU	EQU479	1.0000	1.0000	1.0000	4154.7871
----	EQU	EQU480	.	.	.	-3955.4961
----	EQU	EQU481	.	.	.	4443.8006
----	EQU	EQU482	.	.	.	-199.1877
----	EQU	EQU483	.	.	.	EPS
----	EQU	EQU484	.	.	.	-3998.2660

\_Economic Optimization Program

05/15/01 16:49:39 PAGE 119  
GAMS 2.50A Windows NT/95/98

	LOWER	LEVEL	UPPER	MARGINAL		
----	EQU	EQU485	.	.	.	493.5684
----	EQU	EQU486	.	.	.	EPS
----	EQU	EQU487	.	.	.	-161.2624
----	EQU	EQU488	.	.	.	-161.2639
----	EQU	EQU489	.	.	.	38.0952
----	EQU	EQU490	.	.	.	-197.0497

```

---- EQU EQU491 . . . -161.2654
---- EQU EQU492 . . . -11139.4872
---- EQU EQU493 . . . -4443.8006
---- EQU EQU494 . . . 22520.8873
---- EQU EQU495 . . . 17157.5170
---- EQU EQU496 . . . EPS
---- EQU EQU497 . . . 1.9514
---- EQU EQU498 . . . 19.6953
---- EQU EQU499 . . . 3.1478
---- EQU EQU500 . . . 3.1478
---- EQU EQU501 . . . -6.9218
---- EQU EQU502 . . . 134.7156
---- EQU EQU503 . . . -0.0002
---- EQU EQU504 . . .
---- EQU EQU505 . . . -151.7068
---- EQU EQU506 . . . 14330.6321
---- EQU EQU507 . . . 11673.4641
---- EQU EQU508 . . . -4117.1693
---- EQU EQU509 . . . -3.9178
---- EQU EQU510 . . . 30525.6814
---- EQU EQU511 . . . -4.1171
---- EQU EQU512 . . . -14330.6321
---- EQU EQU513 . . . 4.1551
---- EQU EQU514 . . . 4.1551
---- EQU EQU515 . . . 4.1556
---- EQU EQU516 . . . 3955.4961
---- EQU EQU517 . . . 4.1548
---- EQU EQU518 . . . 4.1548
---- EQU EQU519 . . . -4.1551
---- EQU EQU520 . . . -27844.1751
---- EQU EQU521 . . . -4.1172
---- EQU EQU522 . . . -25205.6495
---- EQU EQU523 . . . -22521.8442
---- EQU EQU524 . . . -19804.5538
---- EQU EQU525 . . . 0.0250
---- EQU EQU526 . . . -0.0044
---- EQU EQU527 . . . 144.4748
---- EQU EQU528 . . . 27844.1751

```

\_Economic Optimization Program

05/15/01 16:49:39 PAGE 120  
GAMS 2.50A Windows NT/95/98

	LOWER	LEVEL	UPPER	MARGINAL
---- EQU EQU529	.	.	.	25205.6495
---- EQU EQU530	.	.	.	19839.1980
---- EQU EQU531	.	.	.	-11673.4641
---- EQU EQU532	.	.	.	-22978.3434
---- EQU EQU533	.	.	.	-14313.2768
---- EQU EQU534	.	.	.	-11382.3569
---- EQU EQU535	.	.	.	11430.5786
---- EQU EQU536	.	.	.	-4.4198
---- EQU EQU537	.	.	.	-646.0399
---- EQU EQU538	.	.	.	-30554.7466
---- EQU EQU539	.	.	.	-17153.4775
---- EQU EQU540	.	.	.	-108.2554
---- EQU EQU541	.	.	.	-84.7653
---- EQU EQU542	.	.	.	15.6546
---- EQU EQU543	.	.	.	-264.3686
---- EQU EQU544	.	.	.	-272.0867
---- EQU EQU545	.	.	.	-274.0357
---- EQU EQU546	.	.	.	-275.1186
---- EQU EQU547	.	.	.	201.5224
---- EQU EQU548	.	.	.	-37.6805
---- EQU EQU549	.	.	.	-237.1473
---- EQU EQU550	.	.	.	-37.8083
---- EQU EQU551	.	.	.	-37.9108
---- EQU EQU552	.	.	.	-0.0041
---- EQU EQU553	.	.	.	197.9946
---- EQU EQU554	.	.	.	-35.7843
---- EQU EQU555	.	.	.	-235.1449
---- EQU EQU556	.	.	.	-35.7858
---- EQU EQU557	.	.	.	-35.7873
---- EQU EQU558	.	.	.	2.1380
---- EQU EQU559	1.0000	1.0000	1.0000	EPS
---- EQU EQU560	1.0000	1.0000	1.0000	-257.6948
---- EQU EQU561	.	.	.	197.9946
---- EQU EQU562	.	.	.	-35.7843
---- EQU EQU563	.	.	.	-235.1449
---- EQU EQU564	.	.	.	-35.7858
---- EQU EQU565	.	.	.	-35.7873
---- EQU EQU566	.	.	.	2.1380
---- EQU EQU567	1.0000	1.0000	1.0000	EPS
---- EQU EQU568	1.0000	1.0000	1.0000	-350.4860
---- EQU EQU569	.	.	.	197.9946
---- EQU EQU570	.	.	.	-35.7843
---- EQU EQU571	.	.	.	-235.1449
---- EQU EQU572	.	.	.	-35.7858

\_Economic Optimization Program

05/15/01 16:49:39 PAGE 121  
GAMS 2.50A Windows NT/95/98

	LOWER	LEVEL	UPPER	MARGINAL
---- EQU EQU573	.	.	.	-35.7873
---- EQU EQU574	.	.	.	2.1380
---- EQU EQU575	1.0000	1.0000	1.0000	-5.8831
---- EQU EQU576	.	.	.	EPS
---- EQU EQU577	.	.	.	247.0809
---- EQU EQU578	.	.	.	-58.8576
---- EQU EQU579	.	.	.	-6.5801
---- EQU EQU580	.	.	.	-247.0795
---- EQU EQU581	.	.	.	-247.0823
---- EQU EQU582	.	.	.	-25.7024
---- EQU EQU583	.	.	.	EPS
---- EQU EQU584	.	.	.	37.9268
---- EQU EQU585	.	.	.	563.7981
---- EQU EQU586	.	.	.	558.6125
---- EQU EQU587	.	.	.	1.6111
---- EQU EQU588	.	.	.	-1.5056
---- EQU EQU589	.	.	.	-0.0062
---- EQU EQU590	.	.	.	-0.1020
---- EQU EQU591	.	.	.	-37.7269
---- EQU EQU592	.	.	.	-237.1746
---- EQU EQU593	.	.	.	-37.8306
---- EQU EQU594	.	.	.	-37.9137
---- EQU EQU595	.	.	.	-0.0033
---- EQU EQU596	.	.	.	-0.0592
---- EQU EQU597	.	.	.	-0.0110
---- EQU EQU598	.	.	.	-78.5463
---- EQU EQU599	.	.	.	96.5662
---- EQU EQU600	.	.	.	561.2303
---- EQU EQU601	.	.	.	85.6422
---- EQU EQU602	.	.	.	90.2179
---- EQU EQU603	.	.	.	EPS
---- EQU EQU604	.	.	.	EPS
---- EQU EQU605	.	.	.	EPS
---- EQU EQU606	.	.	.	-162.6883
---- EQU EQU607	.	.	.	EPS
---- EQU EQU608	.	.	.	-41.5681
---- EQU EQU609	.	.	.	-4.9088
---- EQU EQU610	.	.	.	-3.2363
---- EQU EQU611	.	.	.	-1.1134
---- EQU EQU612	.	.	.	EPS
---- EQU EQU613	.	.	.	0.0008
---- EQU EQU614	.	.	.	EPS
---- EQU EQU615	.	.	.	78.2407
---- EQU EQU616	.	.	.	696.7670

\_Economic Optimization Program

05/15/01 16:49:39 PAGE 122  
GAMS 2.50A Windows NT/95/98

	LOWER	LEVEL	UPPER	MARGINAL
---- EQU EQU617	.	.	.	106.9964
---- EQU EQU618	.	.	.	111.9546
---- EQU EQU619	.	.	.	-196.8561
---- EQU EQU620	.	.	.	8.5154
---- EQU EQU621	.	.	.	238.1716
---- EQU EQU622	.	.	.	36.9750
---- EQU EQU623	.	.	.	38.2620
---- EQU EQU624	.	.	.	237.2945
---- EQU EQU625	.	.	.	37.9263
---- EQU EQU626	.	.	.	37.9257
---- EQU EQU627	.	.	.	237.2919
---- EQU EQU628	.	.	.	37.9250
---- EQU EQU629	.	.	.	37.9255
---- EQU EQU630	.	.	.	37.9245
---- EQU EQU631	1.0000	1.0000	1.0000	EPS
---- EQU EQU632	.	.	.	-25.7024
---- EQU EQU633	.	.	.	EPS
---- EQU EQU634	.	.	.	37.9255
---- EQU EQU635	.	.	.	556.3881
---- EQU EQU636	.	.	.	237.2914
---- EQU EQU637	.	.	.	37.9256
---- EQU EQU638	.	.	.	37.9256
---- EQU EQU639	.	.	.	75.8513
---- EQU EQU640	.	.	.	1122.4106
---- EQU EQU641	.	.	.	474.5864
---- EQU EQU642	.	.	.	75.8513
---- EQU EQU643	.	.	.	75.8513
---- EQU EQU644	.	.	.	EPS
---- EQU EQU645	.	.	.	EPS
---- EQU EQU646	1.0000	1.0000	1.0000	4119.5536
---- EQU EQU647	.	.	.	-25.7024
---- EQU EQU648	.	.	.	EPS
---- EQU EQU649	.	.	.	42.4560
---- EQU EQU650	.	.	.	-174.6816
---- EQU EQU651	.	.	.	EPS
---- EQU EQU652	.	.	.	0.6950
---- EQU EQU653	.	.	.	212.5271
---- EQU EQU654	.	.	.	31.9201
---- EQU EQU655	.	.	.	32.9969
---- EQU EQU656	.	.	.	-1.2253

```

---- EQU EQU657      .      .      .      757.1763
---- EQU EQU658      .      .      .      123.8732
---- EQU EQU659      .      .      .      118.4941
---- EQU EQU660      .      .      .      -0.0235

```

\_Economic Optimization Program

05/15/01 16:49:39 PAGE 123  
GAMS 2.50A Windows NT/95/98

	LOWER	LEVEL	UPPER	MARGINAL
---- EQU EQU661	.	.	.	212.2233
---- EQU EQU662	.	.	.	31.8152
---- EQU EQU663	.	.	.	32.9186
---- EQU EQU664	.	.	.	EPS
---- EQU EQU665	.	.	.	EPS
---- EQU EQU666	.	.	.	-246.6870
---- EQU EQU667	.	.	.	-36.9750
---- EQU EQU668	.	.	.	-38.2620
---- EQU EQU669	.	.	.	-195.4356
---- EQU EQU670	.	.	.	622.1107
---- EQU EQU671	.	.	.	265.6404
---- EQU EQU672	.	.	.	42.4565
---- EQU EQU673	.	.	.	42.4571
---- EQU EQU674	.	.	.	113.7768
---- EQU EQU675	.	.	.	1678.7987
---- EQU EQU676	.	.	.	711.8778
---- EQU EQU677	.	.	.	113.7768
---- EQU EQU678	.	.	.	113.7769
---- EQU EQU679	1.0000	1.0000	1.0000	4599.5101
---- EQU EQU680	.	.	.	EPS
---- EQU EQU681	.	.	.	EPS
---- EQU EQU682	1.0000	1.0000	1.0000	1.5602
---- EQU EQU683	.	.	.	199.7327
---- EQU EQU684	.	.	.	-37.8848
---- EQU EQU685	.	.	.	-558.6050
---- EQU EQU686	.	.	.	-237.2673
---- EQU EQU687	.	.	.	-37.9063
---- EQU EQU688	.	.	.	-37.9233
---- EQU EQU689	.	.	.	-11.6175
---- EQU EQU690	.	.	.	EPS
---- EQU EQU691	.	.	.	18.9638
---- EQU EQU692	.	.	.	118.6847
---- EQU EQU693	.	.	.	18.9661
---- EQU EQU694	.	.	.	18.9689
---- EQU EQU695	.	.	.	18.5709
---- EQU EQU696	.	.	.	116.2140
---- EQU EQU697	.	.	.	18.5723
---- EQU EQU698	.	.	.	36.6645
---- EQU EQU699	.	.	.	-0.4015
---- EQU EQU700	.	.	.	248.1267
---- EQU EQU701	.	.	.	40.5932
---- EQU EQU702	.	.	.	38.8305
---- EQU EQU703	.	.	.	-58.4071
---- EQU EQU704	.	.	.	195.0964

\_Economic Optimization Program

05/15/01 16:49:39 PAGE 124  
GAMS 2.50A Windows NT/95/98

	LOWER	LEVEL	UPPER	MARGINAL
---- EQU EQU705	.	.	.	195.0964
---- EQU EQU706	.	.	.	195.0964
---- EQU EQU707	.	.	.	26.4569
---- EQU EQU708	.	.	.	18.5741
---- EQU EQU709	.	.	.	-11.6175
---- EQU EQU710	1.0000	1.0000	1.0000	2034.8564
---- EQU EQU711	.	.	.	EPS
---- EQU EQU712	1.0000	1.0000	1.0000	EPS
---- EQU EQU713	.	.	.	EPS
---- EQU EQU714	.	.	.	229.4418
---- EQU EQU715	.	.	.	36.6677
---- EQU EQU716	.	.	.	36.6714
---- EQU EQU717	.	.	.	37.5346
---- EQU EQU718	.	.	.	234.8987
---- EQU EQU719	.	.	.	37.5384
---- EQU EQU720	.	.	.	37.5429
---- EQU EQU721	1.0000	1.0000	1.0000	EPS
---- EQU EQU722	.	.	.	-11.6175
---- EQU EQU723	.	.	.	EPS
---- EQU EQU724	.	.	.	24.9951
---- EQU EQU725	.	.	.	156.4133
---- EQU EQU726	.	.	.	24.9971
---- EQU EQU727	.	.	.	24.9994
---- EQU EQU728	.	.	.	11.6694
---- EQU EQU729	.	.	.	73.0285
---- EQU EQU730	.	.	.	11.6706
---- EQU EQU731	.	.	.	11.6719
---- EQU EQU732	1.0000	1.0000	1.0000	2708.3250
---- EQU EQU733	.	.	.	EPS
---- EQU EQU734	.	.	.	EPS
---- EQU EQU735	1.0000	1.0000	1.0000	1267.8697
---- EQU EQU736	.	.	.	1335.9985



```

---- EQU EQU737      .      .      .      6.0683
---- EQU EQU738      .      .      .      3.5666
---- EQU EQU739      .      .      .      2.9062
---- EQU EQU740      .      .      .      0.3678
---- EQU EQU741      .      .      .      .
---- EQU EQU742      .      .      .      330.0284
---- EQU EQU743      .      .      .      14.8947
---- EQU EQU744      .      .      .      11.6539
---- EQU EQU745      .      .      .      0.0111
---- EQU EQU746      -290.0000  -290.0000  -290.0000  0.1887
---- EQU EQU747      .      .      .      EPS
---- EQU EQU748      .      .      .      0.0019
_Economic Optimization Program

```

05/15/01 16:49:39 PAGE 125  
GAMS 2.50A Windows NT/95/98

```

          LOWER      LEVEL      UPPER      MARGINAL
---- EQU EQU749      .      .      .      7.5981224E-6
---- EQU EQU750      .      .      .      3.1867
---- EQU EQU751      -290.0000  -290.0000  -290.0000  -0.1887
---- EQU EQU752      .      .      .      EPS
---- EQU EQU753      .      .      .      -2.3793
---- EQU EQU754      .      .      .      -0.0002
---- EQU EQU755      .      .      .      -0.0003
---- EQU EQU756      .      .      .      0.0054
---- EQU EQU757      414.6000    414.6000    414.6000   -0.0270
---- EQU EQU758      .      .      .      0.0005
---- EQU EQU759      .      .      .      -0.0003
---- EQU EQU760      829.2000    829.2000    829.2000  -0.0002
---- EQU EQU761      .      .      .      1.0758167E-5
---- EQU EQU762      .      .      .      EPS
---- EQU EQU763      .      .      .      -1.503969E-7
---- EQU EQU764      .      .      .      -0.0669
---- EQU EQU765      481.0000    481.0000    481.0000   0.1268
---- EQU EQU766      .      .      .      -0.1765
---- EQU EQU767      .      .      .      0.1229
---- EQU EQU768      962.0000    962.0000    962.0000   0.2458
---- EQU EQU769      .      .      .      0.0005
---- EQU EQU770      1.0000      1.0000      1.0000     2.4347
---- EQU EQU771      .      .      .      0.0005
---- EQU EQU772      1.0000      1.0000      1.0000     3.8482
---- EQU EQU773      .      .      .      0.0005
---- EQU EQU774      .      .      .      0.0008
---- EQU EQU775      .      .      .      0.0008
---- EQU EQU776      .      .      .      .
---- EQU EQU777      .      .      .      0.0008
---- EQU EQU778      .      .      .      1.4840
---- EQU EQU779      .      .      .      1.7898
---- EQU EQU780      .      .      .      -247.0809
---- EQU EQU781      .      .      .      -0.0004
---- EQU EQU782      .      .      .      EPS
---- EQU EQU783      .      .      .      0.0004
---- EQU EQU784      .      .      .      -0.0002
---- EQU EQU785      .      .      .      3.2736710E-5
---- EQU EQU786      .      .      .      EPS
---- EQU EQU787      .      .      .      0.0020
---- EQU EQU788      .      .      .      -0.0027
---- EQU EQU789      .      .      .      0.0016
---- EQU EQU790      .      .      .      -0.0016
---- EQU EQU791      .      .      .      EPS
---- EQU EQU792      .      .      .      -0.0039
_Economic Optimization Program

```

05/15/01 16:49:39 PAGE 126  
GAMS 2.50A Windows NT/95/98

```

          LOWER      LEVEL      UPPER      MARGINAL
---- EQU EQU793      .      .      .      2.1685
---- EQU EQU794      .      .      .      2.3503
---- EQU EQU795      .      .      .      -130.4259
---- EQU EQU796      .      .      .      -0.0002
---- EQU EQU797      1.0000      1.0000      1.0000    -74.4210
---- EQU EQU798      1.0000      1.0000      1.0000   -4.2485
---- EQU EQU799      .      .      .      0.0002
---- EQU EQU800      .      .      .      -0.8963
---- EQU EQU801      .      .      .      -3.0854
---- EQU EQU802      .      .      .      -3.0636
---- EQU EQU803      .      .      .      -4.0226
---- EQU EQU804      .      .      .      205.0403
---- EQU EQU805      1.0000      1.0000      1.0000   -13.7947
---- EQU EQU806      1.0000      1.0000      1.0000    1.2921
---- EQU EQU807      1.0000      1.0000      1.0000     EPS
---- EQU EQU808      .      .      .      0.0004
---- EQU EQU809      .      .      .      0.0004
---- EQU EQU810      .      .      .      -36.1925
---- EQU EQU811      .      .      .      -36.9649
---- EQU EQU812      .      .      .      -235.1859
---- EQU EQU813      .      .      .      -44.0350
---- EQU EQU814      .      .      .      197.5278
---- EQU EQU815      1.0000      1.0000      1.0000  -34.6338
---- EQU EQU816      .      .      .      -0.0012

```

----	EQU EQU817	1.0000	1.0000	1.0000	-0.6165
----	EQU EQU818	.	.	.	-0.0004
----	EQU EQU819	1.0000	1.0000	1.0000	2.2228
----	EQU EQU820	.	.	.	0.0013
----	EQU EQU821	.	.	.	-0.0026
----	EQU EQU822	1.0000	1.0000	1.0000	-3.1189
----	EQU EQU823	.	.	.	-129.8636
----	EQU EQU824	.	.	.	-75.0613
----	EQU EQU825	.	.	.	-0.0028
----	EQU EQU826	.	.	.	-0.0033
----	EQU EQU827	.	.	.	0.0262
----	EQU EQU828	.	.	.	-0.0395
----	EQU EQU829	.	.	.	179.0351
----	EQU EQU830	.	.	.	0.0125
----	EQU EQU831	.	.	.	0.0015
----	EQU EQU832	.	.	.	-0.0041
----	EQU EQU833	.	.	.	EPS
----	EQU EQU834	.	.	.	-0.0325
----	EQU EQU835	.	.	.	-0.0074
----	EQU EQU836	.	.	.	EPS

\_Economic Optimization Program

05/15/01 16:49:39 PAGE 127  
GAMS 2.50A Windows NT/95/98

	LOWER	LEVEL	UPPER	MARGINAL
----	EQU EQU837	.	.	97.4240
----	EQU EQU838	.	.	561.7365
----	EQU EQU839	.	.	86.0476
----	EQU EQU840	.	.	90.2670
----	EQU EQU841	.	.	-0.0037
----	EQU EQU842	.	.	0.0017
----	EQU EQU843	.	.	2.4700
----	EQU EQU844	.	.	-76.4291
----	EQU EQU845	.	.	90.2491
----	EQU EQU846	.	.	85.8953
----	EQU EQU847	.	.	561.5435
----	EQU EQU848	.	.	97.0979
----	EQU EQU849	.	.	122.1607
----	EQU EQU850	.	.	122.0308
----	EQU EQU851	.	.	764.2605
----	EQU EQU852	.	.	1799.8378
----	EQU EQU853	.	.	121.8674
----	EQU EQU854	.	.	3.2051
----	EQU EQU855	.	.	0.0075
----	EQU EQU856	.	.	36.7935
----	EQU EQU857	.	.	36.5197
----	EQU EQU858	.	.	235.6900
----	EQU EQU859	.	.	43.8635
----	EQU EQU860	.	.	0.0012
----	EQU EQU861	.	.	-0.0008
----	EQU EQU862	.	.	-197.5278
----	EQU EQU863	.	.	122.1752
----	EQU EQU864	.	.	122.1478
----	EQU EQU865	.	.	764.4052
----	EQU EQU866	.	.	1799.4677
----	EQU EQU867	.	.	122.1131
----	EQU EQU868	.	.	-5.583682E-6
----	EQU EQU869	.	.	-1.522649E-5
----	EQU EQU870	.	.	-0.0002
----	EQU EQU871	.	.	-0.0008
----	EQU EQU872	.	.	-0.0005
----	EQU EQU873	.	.	-0.0008
----	EQU EQU874	.	.	-0.0006
----	EQU EQU875	.	.	0.0012
----	EQU EQU876	.	.	-0.0011
----	EQU EQU877	.	.	0.0006
----	EQU EQU878	.	.	-0.0005
----	EQU EQU879	.	.	0.0007
----	EQU EQU880	.	.	-0.0007

\_Economic Optimization Program

05/15/01 16:49:39 PAGE 128  
GAMS 2.50A Windows NT/95/98

	LOWER	LEVEL	UPPER	MARGINAL
----	EQU EQU881	.	.	0.0014
----	EQU EQU882	.	.	-0.0005
----	EQU EQU883	.	.	0.0019
----	EQU EQU884	.	.	-0.0008
----	EQU EQU885	.	.	0.0026
----	EQU EQU886	.	.	-0.0011
----	EQU EQU887	.	.	0.0013
----	EQU EQU888	.	.	-0.0005
----	EQU EQU889	.	.	EPS
----	EQU EQU890	1.0000	1.0000	1.0000 580.9977
----	EQU EQU891	.	.	EPS
----	EQU EQU892	.	.	EPS
----	EQU EQU893	.	.	EPS
----	EQU EQU894	1.0000	1.0000	1.0000 -775.7304
----	EQU EQU895	.	.	-30.5486
----	EQU EQU896	.	.	0.9622

----	EQU EQU897	.	.	.	EPS	
----	EQU EQU898	.	.	.	0.6939	
----	EQU EQU899	1.0000	1.0000	1.0000	-2.4466	
----	EQU EQU900	.	.	.	-20.4102	
----	EQU EQU901	1.0000	1.0000	1.0000	2.3301	
----	EQU EQU902	.	.	.	17.6850	
----	EQU EQU903	1.0000	1.0000	1.0000	-4.8969	
----	EQU EQU904	.	.	.	6.3563	
----	EQU EQU905	.	.	.	0.0479	
----	EQU EQU906	.	.	.	0.2052	
----	EQU EQU907	.	.	.	0.4431	
----	EQU EQU908	.	.	.	0.5155	
----	EQU EQU909	.	.	.	0.2513	
----	EQU EQU910	.	.	.	0.1975	
----	EQU EQU911	.	.	.	-0.0239	
----	EQU EQU912	.	.	.	-0.1636	
----	EQU EQU913	.	.	.	-2.4210	
----	EQU EQU914	.	.	.	.	
----	EQU EQU915	.	.	.	EPS	
----	EQU EQU916	.	.	.	-3.1041	
----	EQU EQU917	.	.	.	EPS	
----	EQU EQU918	.	.	.	2.3301	
----	EQU EQU919	.	.	.	1.8464	
----	EQU EQU920	.	.	.	2.2595	
----	EQU EQU921	.	.	.	3.0548	
----	EQU EQU922	.	.	.	3.4327	
----	EQU EQU923	.	.	.	EPS	
----	EQU EQU924	1.0000	1.0000	1.0000	EPS	EPS

\_Economic Optimization Program

	LOWER	LEVEL	UPPER	MARGINAL	
----	EQU EQU925	.	.	EPS	
----	EQU EQU926	.	.	EPS	
----	EQU EQU927	.	.	-8.129644E-5	
----	EQU EQU928	.	.	-0.0052	
----	EQU EQU929	.	.	-8.338969E-5	
----	EQU EQU930	.	.	EPS	
----	EQU EQU931	.	.	0.0002	
----	EQU EQU932	.	.	3.2458764E-7	
----	EQU EQU933	.	.	-0.0022	
----	EQU EQU934	.	.	EPS	
----	EQU EQU935	.	.	EPS	
----	EQU EQU936	.	.	-0.0095	
----	EQU EQU937	.	.	-0.0244	
----	EQU EQU938	.	.	-1.5881	
----	EQU EQU939	.	.	-0.0251	
----	EQU EQU940	.	.	EPS	
----	EQU EQU941	.	.	0.0553	
----	EQU EQU942	.	.	9.9525061E-5	
----	EQU EQU943	.	.	-0.6654	
----	EQU EQU944	.	.	-5.446712E-7	
----	EQU EQU945	1.000000E-20	1.000000E-20	1.000000E-20	-0.0030
----	EQU EQU946	1.000000E-10	1.000000E-10	1.000000E-10	.
----	EQU EQU947	1.0000	1.0000	1.0000	0.0723
----	EQU EQU948	1.0000	1.0000	1.0000	-3.0164
----	EQU EQU949	1.0000	1.0000	1.0000	201.7389
----	EQU EQU950	.	.	-35.6602	
----	EQU EQU951	.	.	EPS	
----	EQU EQU952	.	.	EPS	
----	EQU EQU953	.	.	9.1457	
----	EQU EQU954	.	.	-197.9394	
----	EQU EQU955	.	.	EPS	
----	EQU EQU956	.	.	0.0244	
----	EQU EQU957	.	.	-0.0031	
----	EQU EQU958	.	.	-3.105374E-5	
----	EQU EQU959	.	.	849.9004	
----	EQU EQU960	.	.	-12.2702	
----	EQU EQU961	.	.	EPS	
----	EQU EQU962	.	.	EPS	
----	EQU EQU963	.	.	.	
----	EQU EQU964	.	.	-0.1840	
----	EQU EQU965	1.0000	1.0000	1.0000	5.8053
----	EQU EQU966	.	.	.	236.4038
----	EQU EQU967	.	.	.	-4.9447
----	EQU EQU968	1.0000	1.0000	1.0000	-6.1668

\_Economic Optimization Program

	LOWER	LEVEL	UPPER	MARGINAL
----	EQU EQU969	.	.	-135.8837
----	EQU EQU970	.	.	3.6117
----	EQU EQU971	.	.	-173.7968
----	EQU EQU972	.	.	-58.6936
----	EQU EQU973	.	.	-43.9023
----	EQU EQU974	.	.	-33.3131
----	EQU EQU975	.	.	3.3458312E-5
----	EQU EQU976	.	.	0.0002

```

---- EQU EQU977      .      .      .      -9.868383E-7
---- EQU EQU978      .      .      .      -156.5698
---- EQU EQU979      .      .      .      39.4413
---- EQU EQU980      .      .      .      -161.4870
---- EQU EQU981      .      .      .      -168.9435
---- EQU EQU982      .      .      .      EPS
---- EQU EQU983      .      .      .      EPS
---- EQU EQU984      .      .      .      3.7540
---- EQU EQU985      .      .      .      EPS
---- EQU EQU986      .      .      .      -0.0033
---- EQU EQU987      .      .      .      -0.0002
---- EQU EQU988      .      .      .      -12.2927
---- EQU EQU989      .      .      .      -0.0002
---- EQU EQU990      .      .      .      EPS
---- EQU EQU991      .      .      .      EPS
---- EQU EQU992      .      .      .      0.0005
---- EQU EQU993      .      .      .      18.2882
---- EQU EQU994      .      .      .      0.0002
---- EQU EQU995      .      .      .      -0.4178
---- EQU EQU996      .      .      .      -0.0004
---- EQU EQU997      .      .      .      -0.0004
---- EQU EQU998      .      .      .      -19.5119
---- EQU EQU999      .      .      .      EPS
---- EQU EQU1000     .      .      .      EPS
---- EQU EQU1001     .      .      .      0.0004
---- EQU EQU1002     .      .      .      0.0008
---- EQU EQU1003     .      .      .      23.1579
---- EQU EQU1004     .      .      .      -0.0005
---- EQU EQU1005     .      .      .      -0.5101
---- EQU EQU1006     .      .      .      -0.0005
---- EQU EQU1007     .      .      .      -52.9250
---- EQU EQU1008     .      .      .      EPS
---- EQU EQU1009     .      .      .      EPS
---- EQU EQU1010     .      .      .      0.0005
---- EQU EQU1011     .      .      .      0.0011
---- EQU EQU1012     .      .      .      57.4111

```

\_Economic Optimization Program

05/15/01 16:49:39 PAGE 131  
GAMS 2.50A Windows NT/95/98

```

          LOWER      LEVEL      UPPER      MARGINAL
---- EQU EQU1013     .      .      .      -0.0002
---- EQU EQU1014     .      .      .      -0.2272
---- EQU EQU1015     .      .      .      -26.9557
---- EQU EQU1016     .      .      .      14.7139
---- EQU EQU1017     .      .      .      EPS
---- EQU EQU1018     .      .      .      -1.3083
---- EQU EQU1019     .      .      .      EPS
---- EQU EQU1020     .      .      .      EPS
---- EQU EQU1021     .      .      .      106.6872
---- EQU EQU1022     .      .      .      -53.9898
---- EQU EQU1023     .      .      .      -17.7963
---- EQU EQU1024     .      .      .      -13.2202
---- EQU EQU1025     .      .      .      -3.7871
---- EQU EQU1026     1.0000    1.0000    1.0000    -8.7174
---- EQU EQU1027     .      .      .      EPS
---- EQU EQU1028     .      .      .      EPS
---- EQU EQU1029     .      .      .      EPS
---- EQU EQU1030     .      .      .      EPS
---- EQU EQU1031     .      .      .      EPS
---- EQU EQU1032     .      .      .      EPS
---- EQU EQU1033     .      .      .      196.8561
---- EQU EQU1034     .      .      .      -0.0002
---- EQU EQU1035     .      .      .      -19.9284
---- EQU EQU1036     .      .      .      EPS
---- EQU EQU1037     .      .      .      0.0002
---- EQU EQU1038     .      .      .      EPS
---- EQU EQU1039     .      .      .      27.2255
---- EQU EQU1040     .      .      .      0.0005
---- EQU EQU1041     .      .      .      28.7143
---- EQU EQU1042     .      .      .      0.8837
---- EQU EQU1043     .      .      .      151.6290
---- EQU EQU1044     .      .      .      24.0227
---- EQU EQU1045     .      .      .      24.2086
---- EQU EQU1046     .      .      .      109.0437
---- EQU EQU1047     .      .      .      3.8482
---- EQU EQU1048     .      .      .      597.3280
---- EQU EQU1049     .      .      .      94.6296
---- EQU EQU1050     .      .      .      95.4174
---- EQU EQU1051     .      .      .      26.4268
---- EQU EQU1052     .      .      .      0.9805
---- EQU EQU1053     .      .      .      139.5615
---- EQU EQU1054     .      .      .      22.1017
---- EQU EQU1055     .      .      .      22.2811
---- EQU EQU1056     .      .      .      76.7991

```

\_Economic Optimization Program

05/15/01 16:49:39 PAGE 132  
GAMS 2.50A Windows NT/95/98

```

          LOWER      LEVEL      UPPER      MARGINAL

```

----	EQU	EQU1057	.	.	.	4.8345	
----	EQU	EQU1058	.	.	.	550.5377	
----	EQU	EQU1059	.	.	.	87.8279	
----	EQU	EQU1060	.	.	.	-0.0216	
----	EQU	EQU1061	.	.	.	EPS	
----	EQU	EQU1062	.	.	.	EPS	
----	EQU	EQU1063	.	.	.	0.1840	
----	EQU	EQU1064	.	.	.	88.1256	
----	EQU	EQU1065	.	.	.	0.0118	
----	EQU	EQU1066	.	.	.	0.0087	
----	EQU	EQU1067	1.0000	1.0000	1.0000	0.8837	
----	EQU	EQU1068	1.0000	1.0000	1.0000	0.9805	
----	EQU	EQU1069	.	.	.	-0.0023	
----	EQU	EQU1070	.	.	.	-0.0023	
----	EQU	EQU1071	.	.	.	197.3845	
----	EQU	EQU1072	.	.	.	-0.0023	
----	EQU	EQU1073	1.0000	1.0000	1.0000	0.0671	
----	EQU	EQU1074	1.0000	1.0000	1.0000	EPS	
----	EQU	EQU1075	.	.	.	-0.0021	
----	EQU	EQU1076	1.0000	1.0000	1.0000	EPS	
----	EQU	EQU1077	.	.	.	-0.0021	
----	EQU	EQU1078	1.0000	1.0000	1.0000	EPS	
----	EQU	EQU1079	.	.	.	-0.0021	
----	EQU	EQU1080	.	.	.	197.3845	
----	EQU	EQU1081	.	.	.	0.0015	
----	EQU	EQU1082	.	.	.	0.0015	
----	EQU	EQU1083	.	.	.	-197.3845	
----	EQU	EQU1084	.	.	.	0.0015	
----	EQU	EQU1085	1.0000	1.0000	1.0000		
----	EQU	EQU1086	1.0000	1.0000	1.0000	EPS	
----	EQU	EQU1087	.	.	.	EPS	
----	EQU	EQU1088	.	.	.	-0.0015	
----	EQU	EQU1089	.	.	.	1.7598832E-6	
----	EQU	EQU1090	.	.	.	1.7609987E-6	
----	EQU	EQU1091	.	.	.	4.5385072E-6	
----	EQU	EQU1092	.	.	.	0.0019	
----	EQU	EQU1093	.	.	.	0.0002	
----	EQU	EQU1094	.	.	.	0.0005	
----	EQU	EQU1095	1.0000	1.0000	1.0000	-2.3757	
----	EQU	EQU1096	1.0000	1.0000	1.0000	0.5264	
----	EQU	EQU1097	.	.	.	3.1443	
----	EQU	EQU1098	.	.	.	0.1897	
----	EQU	EQU1099	1.0000	1.0000	1.0000	54.7188	
----	EQU	EQU1100	.	.	.	-0.0002	

\_Economic Optimization Program

05/15/01 16:49:39 PAGE 133  
GAMS 2.50A Windows NT/95/98

	LOWER	LEVEL	UPPER	MARGINAL			
----	EQU	EQU1101	.	.	.	-0.0148	
----	EQU	EQU1102	.	.	.	-0.0036	
----	EQU	EQU1103	.	.	.	-0.0002	
----	EQU	EQU1104	.	.	.	-0.0113	
----	EQU	EQU1105	1.0000	1.0000	1.0000	-18.4516	
----	EQU	EQU1106	.	.	.	-20.5752	
----	EQU	EQU1107	.	.	.	-10.2335	
----	EQU	EQU1108	.	.	.	-204.8089	
----	EQU	EQU1109	.	.	.	1.4377	
----	EQU	EQU1110	1.0000	1.0000	1.0000	5.5419	
----	EQU	EQU1111	.	.	.	160.4563	
----	EQU	EQU1112	.	.	.	-3.0240	
----	EQU	EQU1113	.	.	.	4.3872	
----	EQU	EQU1114	.	.	.	-19.0896	
----	EQU	EQU1115	.	.	.	-8.6305	
----	EQU	EQU1116	.	.	.	-4.9457	
----	EQU	EQU1117	.	.	.	2.0252	
----	EQU	EQU1118	.	.	.	-6.6887	
----	EQU	EQU1119	.	.	.	-1.3964	
----	EQU	EQU1120	1.0000	1.0000	1.0000	EPS	
----	EQU	EQU1121	.	.	.	-7.1461	
----	EQU	EQU1122	.	.	.	10.4684	
----	EQU	EQU1123	.	.	.	0.7707	
----	EQU	EQU1124	1.0000	1.0000	1.0000	EPS	
----	EQU	EQU1125	.	.	.	-2.391058E-6	
----	EQU	EQU1126	.	.	.	2.4527452E-5	
----	EQU	EQU1127	.	.	.	0.0060	
----	EQU	EQU1128	.	.	.	0.0005	
----	EQU	EQU1129	.	.	.	3.1975	
----	EQU	EQU1130	.	.	.	2.4430	
----	EQU	EQU1131	.	.	.	1.8439	
----	EQU	EQU1132	1.0000	1.0000	1.0000	13.9991	
----	EQU	EQU1133	.	.	.	-2.7660	
----	EQU	EQU1134	.	.	.	-2.2166	
----	EQU	EQU1135	.	.	.	-1.1048	
----	EQU	EQU1136	1.0000	1.0000	1.0000	EPS	
----	EQU	EQU1137	.	.	.	5.6286907E-7	
----	EQU	EQU1138	.	.	.	-9.772393E-6	
----	EQU	EQU1139	.	.	.	0.0015	
----	EQU	EQU1140	.	.	.	-0.0007	
----	EQU	EQU1141	.	.	.	-0.0013	
----	EQU	EQU1142	.	.	.	-3.3042	

---- EQU EQU1143 . . . -5.4321  
 ---- EQU EQU1144 . . . -9.7107  
 \_Economic Optimization Program

05/15/01 16:49:39 PAGE 134  
 GAMS 2.50A Windows NT/95/98

	LOWER	LEVEL	UPPER	MARGINAL
---- EQU EQU1145	.	.	.	-2.6925
---- EQU EQU1146	.	.	.	EPS
---- EQU EQU1147	.	.	.	-1.173723E-6
---- EQU EQU1148	.	.	.	EPS
---- EQU EQU1149	.	.	.	-0.0007
---- EQU EQU1150	.	.	.	-0.0033
---- EQU EQU1151	.	.	.	-0.0224
---- EQU EQU1152	.	.	.	1.0822804E-7
---- EQU EQU1153	.	.	.	-0.0062
---- EQU EQU1154	.	.	.	-1.9093
---- EQU EQU1155	.	.	.	-0.4248
---- EQU EQU1156	.	.	.	-0.5443
---- EQU EQU1157	.	.	.	EPS
---- EQU EQU1158	.	.	.	-3.419010E-7
---- EQU EQU1159	.	.	.	-0.0012
---- EQU EQU1160	152.2500	152.2500	152.2500	EPS
---- EQU EQU1161	181.2500	181.2500	181.2500	0.0024
---- EQU EQU1162	118.9000	118.9000	118.9000	-0.0023
---- EQU EQU1163	40.6000	40.6000	40.6000	0.0003
---- EQU EQU1164	9.8600	9.8600	9.8600	-0.0107
---- EQU EQU1165	.	.	.	0.0005
---- EQU EQU1166	.	.	.	0.0008
---- EQU EQU1167	.	.	.	0.0011
---- EQU EQU1168	.	.	.	0.0005
---- EQU EQU1169	.	.	.	-197.3845
---- EQU EQU1170	.	.	.	-0.1433
---- EQU EQU1171	.	.	.	42.2773
---- EQU EQU1172	.	.	.	233.4949
---- EQU EQU1173	.	.	.	35.2285
---- EQU EQU1174	.	.	.	34.5310
---- EQU EQU1175	.	.	.	-1.6571
---- EQU EQU1176	.	.	.	38.7692
---- EQU EQU1177	.	.	.	234.8470
---- EQU EQU1178	.	.	.	33.9297
---- EQU EQU1179	.	.	.	35.6850
---- EQU EQU1180	.	.	.	-2.4431
---- EQU EQU1181	.	.	.	8.4227
---- EQU EQU1182	.	.	.	-161.8800
---- EQU EQU1183	.	.	.	1.3499
---- EQU EQU1184	.	.	.	-870.8523
---- EQU EQU1185	.	.	.	-135.6765
---- EQU EQU1186	.	.	.	-132.8731
---- EQU EQU1187	.	.	.	73.6341
---- EQU EQU1188	.	.	.	-93.7551

\_Economic Optimization Program

05/15/01 16:49:39 PAGE 135  
 GAMS 2.50A Windows NT/95/98

	LOWER	LEVEL	UPPER	MARGINAL
---- EQU EQU1189	.	.	.	-557.9297
---- EQU EQU1190	.	.	.	-82.1982
---- EQU EQU1191	.	.	.	-86.2782
---- EQU EQU1192	.	.	.	4.0072
---- EQU EQU1193	.	.	.	-0.0040
---- EQU EQU1194	.	.	.	-0.0140
---- EQU EQU1195	.	.	.	EPS
---- EQU EQU1196	.	.	.	0.0047
---- EQU EQU1197	.	.	.	EPS
---- EQU EQU1198	.	.	.	-0.0002
---- EQU EQU1199	.	.	.	-0.2754
---- EQU EQU1200	.	.	.	1.2921
---- EQU EQU1201	.	.	.	0.0983
---- EQU EQU1202	.	.	.	-0.1999
---- EQU EQU1203	1.0000	1.0000	1.0000	EPS
---- EQU EQU1204	.	.	.	-0.0022
---- EQU EQU1205	.	.	.	-0.0110
---- EQU EQU1206	1.0000	1.0000	1.0000	12.9395
---- EQU EQU1207	.	.	.	0.0029
---- EQU EQU1208	1.0000	1.0000	1.0000	EPS
---- EQU EQU1209	1.0000	1.0000	1.0000	EPS
---- EQU EQU1210	.	.	.	EPS
---- EQU EQU1211	.	.	.	EPS
---- EQU EQU1212	.	.	.	EPS
---- EQU EQU1213	.	.	.	EPS
---- EQU EQU1214	.	.	.	EPS
---- EQU EQU1215	.	.	.	EPS
---- EQU EQU1216	.	.	.	EPS
---- EQU EQU1217	.	.	.	EPS
---- EQU EQU1218	.	.	.	EPS
---- EQU EQU1219	.	.	.	EPS
---- EQU EQU1220	.	.	.	EPS
---- EQU EQU1221	.	.	.	EPS
---- EQU EQU1222	.	.	.	EPS

```

---- EQU EQU1223      .      .      .      EPS
---- EQU EQU1224      .      .      .      EPS
---- EQU EQU1225      .      .      .      EPS
---- EQU EQU1226      .      .      .      13.1442
---- EQU EQU1227      .      .      .      EPS
---- EQU EQU1228      .      .      .      EPS
---- EQU EQU1229      .      .      .      EPS
---- EQU EQU1230      .      .      .      EPS
---- EQU EQU1231      .      .      .      EPS
---- EQU EQU1232      .      .      .      -57.9659

```

\_Economic Optimization Program

05/15/01 16:49:39 PAGE 136  
GAMS 2.50A Windows NT/95/98

	LOWER	LEVEL	UPPER	MARGINAL
---- EQU EQU1233	.	.	.	EPS
---- EQU EQU1234	1.0000	1.0000	1.0000	EPS
---- EQU EQU1235	1.0000	1.0000	1.0000	EPS
---- EQU EQU1236	537.9500	537.9500	537.9500	-4.645815E-5
---- EQU EQU1237	152.2500	152.2500	152.2500	EPS
---- EQU EQU1238	181.2500	181.2500	181.2500	0.0006
---- EQU EQU1239	118.9000	118.9000	118.9000	-0.0006
---- EQU EQU1240	40.6000	40.6000	40.6000	0.0001
---- EQU EQU1241	9.8600	9.8600	9.8600	-0.0027
---- EQU EQU1242	.	.	.	0.4930
---- EQU EQU1243	.	.	.	-0.1965
---- EQU EQU1244	.	.	.	0.7608
---- EQU EQU1245	.	.	.	-0.2993
---- EQU EQU1246	.	.	.	1.2931
---- EQU EQU1247	.	.	.	-3.8885
---- EQU EQU1248	.	.	.	0.3595
---- EQU EQU1249	.	.	.	-1.4025
---- EQU EQU1250	.	.	.	0.0583
---- EQU EQU1251	.	.	.	-0.2714
---- EQU EQU1252	.	.	.	8.0376
---- EQU EQU1253	.	.	.	EPS
---- EQU EQU1254	1.0000	1.0000	1.0000	0.0576
---- EQU EQU1255	1.0000	1.0000	1.0000	EPS
---- EQU EQU1256	.	.	.	0.0093
---- EQU EQU1257	.	.	.	-0.0009
---- EQU EQU1258	.	.	.	0.0009
---- EQU EQU1259	.	.	.	EPS
---- EQU EQU1260	.	.	.	0.0133
---- EQU EQU1261	.	.	.	-0.0051
---- EQU EQU1262	.	.	.	-2.3793
---- EQU EQU1263	.	.	.	-0.0129
---- EQU EQU1264	.	.	.	-0.0015
---- EQU EQU1265	.	.	.	EPS
---- EQU EQU1266	.	.	.	-0.0004
---- EQU EQU1267	.	.	.	-0.0003
---- EQU EQU1268	.	.	.	EPS
---- EQU EQU1269	.	.	.	EPS
---- EQU EQU1270	.	.	.	1.3511
---- EQU EQU1271	.	.	.	-0.2693
---- EQU EQU1272	.	.	.	0.8084
---- EQU EQU1273	.	.	.	-0.1876
---- EQU EQU1274	.	.	.	0.2959
---- EQU EQU1275	.	.	.	-0.1757
---- EQU EQU1276	.	.	.	0.1442

\_Economic Optimization Program

05/15/01 16:49:39 PAGE 137  
GAMS 2.50A Windows NT/95/98

	LOWER	LEVEL	UPPER	MARGINAL
---- EQU EQU1277	.	.	.	-1.2676
---- EQU EQU1278	.	.	.	0.4484
---- EQU EQU1279	.	.	.	-2.0993
---- EQU EQU1280	1.0000	1.0000	1.0000	EPS
---- EQU EQU1281	1.0000	1.0000	1.0000	EPS
---- EQU EQU1282	.	.	.	EPS
---- EQU EQU1283	.	.	.	EPS
---- EQU EQU1284	.	.	.	-0.2875
---- EQU EQU1285	.	.	.	0.1510
---- EQU EQU1286	.	.	.	-0.5846
---- EQU EQU1287	.	.	.	0.2854
---- EQU EQU1288	.	.	.	-1.4742
---- EQU EQU1289	.	.	.	-0.6680
---- EQU EQU1290	.	.	.	0.5579
---- EQU EQU1291	.	.	.	-2.4043
---- EQU EQU1292	.	.	.	0.9941
---- EQU EQU1293	.	.	.	-5.9615
---- EQU EQU1294	.	.	.	0.0165
---- EQU EQU1295	.	.	.	-0.9929
---- EQU EQU1296	.	.	.	-0.0005
---- EQU EQU1297	.	.	.	-1.2583
---- EQU EQU1298	.	.	.	36.5555
---- EQU EQU1299	.	.	.	41.9813
---- EQU EQU1300	.	.	.	235.4692
---- EQU EQU1301	.	.	.	36.2546
---- EQU EQU1302	.	.	.	-197.3845

----	EQU	EQU1303	.	.	.	EPS		
----	EQU	EQU1304	537.9500	537.9500	537.9500	-558.5066	-0.0001	
----	EQU	EQU1305	.	.	.	EPS		
----	EQU	EQU1306	.	.	.	-161.2895		
----	EQU	EQU1307	.	.	.	-0.0004		
----	EQU	EQU1308	.	.	.	0.0021		
----	EQU	EQU1309	.	.	.	2.9384		
----	EQU	EQU1310	.	.	.	199.2414		
----	EQU	EQU1311	.	.	.	0.0563		
----	EQU	EQU1312	.	.	.	-37.9154		
----	EQU	EQU1313	.	.	.	0.0005		
----	EQU	EQU1314	.	.	.	1.0000	0.2372	
----	EQU	EQU1315	1.0000	1.0000	1.0000	-0.0028		
----	EQU	EQU1316	.	.	.	1.0000	-7.2623	
----	EQU	EQU1317	1.0000	1.0000	1.0000	0.0012		
----	EQU	EQU1318	.	.	.	4.2362975E-5		
----	EQU	EQU1319	.	.	.	0.0060		
----	EQU	EQU1320	.	.	.			

\_Economic Optimization Program

05/15/01 16:49:39 PAGE 138  
GAMS 2.50A Windows NT/95/98

	LOWER	LEVEL	UPPER	MARGINAL				
----	EQU	EQU1321	.	.	.	0.0005		
----	EQU	EQU1322	.	.	.	0.0034		
----	EQU	EQU1323	.	.	.	0.0022		
----	EQU	EQU1324	.	.	.	5.7905730E-5		
----	EQU	EQU1325	.	.	.	0.0044		
----	EQU	EQU1326	.	.	.	0.0008		
----	EQU	EQU1327	.	.	.	-0.0034		
----	EQU	EQU1328	.	.	.	0.0011		
----	EQU	EQU1329	.	.	.	0.0066		
----	EQU	EQU1330	.	.	.	2.7962082E-5		
----	EQU	EQU1331	.	.	.	0.0051		
----	EQU	EQU1332	.	.	.	-0.0034		
----	EQU	EQU1333	.	.	.	0.0005		
----	EQU	EQU1334	.	.	.	0.0025		
----	EQU	EQU1335	.	.	.	EPS		
----	EQU	EQU1336	.	.	.	0.0050		
----	EQU	EQU1337	.	.	.	0.0015		
----	EQU	EQU1338	.	.	.	EPS		
----	EQU	EQU1339	.	.	.	0.0007		
----	EQU	EQU1340	.	.	.	0.0172		
----	EQU	EQU1341	.	.	.	-0.0020		
----	EQU	EQU1342	.	.	.	EPS		
----	EQU	EQU1343	.	.	.	EPS		
----	EQU	EQU1344	.	.	.	EPS		
----	EQU	EQU1345	.	.	.	EPS		
----	EQU	EQU1346	.	.	.	EPS		
----	EQU	EQU1347	.	.	.	EPS		
----	EQU	EQU1348	.	.	.	EPS		
----	EQU	EQU1349	.	.	.	EPS		
----	EQU	EQU1350	.	.	.	EPS		
----	EQU	EQU1351	.	.	.	EPS		
----	EQU	EQU1352	.	.	.	EPS		
----	EQU	EQU1353	.	.	.	EPS		
----	EQU	EQU1354	.	.	.	EPS		
----	EQU	EQU1355	.	.	.	EPS		
----	EQU	EQU1356	.	.	.	EPS		
----	EQU	EQU1357	.	.	.	EPS		
----	EQU	EQU1358	.	.	.	EPS		
----	EQU	EQU1359	.	.	.	EPS		
----	EQU	EQU1360	.	.	.	1753.5625		
----	EQU	EQU1361	.	.	.	-558.9070		
----	EQU	EQU1362	.	.	.	458.8627		
----	EQU	EQU1363	.	.	.	-499.6314		
----	EQU	EQU1364	.	.	.	-0.0033		

\_Economic Optimization Program

05/15/01 16:49:39 PAGE 139  
GAMS 2.50A Windows NT/95/98

	LOWER	LEVEL	UPPER	MARGINAL				
----	EQU	EQU1365	.	.	.	EPS		
----	EQU	EQU1366	.	.	.	-502.1738		
----	EQU	EQU1367	.	.	.	-302.8299		
----	EQU	EQU1368	.	.	.	-302.9130		
----	EQU	EQU1369	.	.	.	-0.2124		
----	EQU	EQU1370	.	.	.	72.2686		
----	EQU	EQU1371	.	.	.	0.0053		
----	EQU	EQU1372	.	.	.	EPS		
----	EQU	EQU1373	.	.	.	48.7113		
----	EQU	EQU1374	.	.	.	721.8557		
----	EQU	EQU1375	.	.	.	718.6371		
----	EQU	EQU1376	.	.	.	450.8974		
----	EQU	EQU1377	.	.	.	-0.0428		
----	EQU	EQU1378	.	.	.	EPS		
----	EQU	EQU1379	.	.	.	71.9146		
----	EQU	EQU1380	.	.	.	43.5843		
----	EQU	EQU1381	.	.	.	43.5842		
----	EQU	EQU1382	.	.	.	-20.1904		



----	EQU	EQU1383	.	.	.	EPS
----	EQU	EQU1384	.	.	.	EPS
----	EQU	EQU1385	.	.	.	EPS
----	EQU	EQU1386	.	.	.	438.1338
----	EQU	EQU1387	.	.	.	-6.9549
----	EQU	EQU1388	.	.	.	72.2686
----	EQU	EQU1389	.	.	.	EPS
----	EQU	EQU1390	.	.	.	43.5843
----	EQU	EQU1391	.	.	.	71.9146
----	EQU	EQU1392	.	.	.	-0.0428
----	EQU	EQU1393	.	.	.	0.0053
----	EQU	EQU1394	.	.	.	43.9408
----	EQU	EQU1395	.	.	.	EPS
----	EQU	EQU1396	.	.	.	EPS
----	EQU	EQU1397	.	.	.	43.5842
----	EQU	EQU1398	.	.	.	EPS
----	EQU	EQU1399	.	.	.	790.9057
----	EQU	EQU1400	.	.	.	EPS
----	EQU	EQU1401	.	.	.	-20.1904
----	EQU	EQU1402	.	.	.	EPS
----	EQU	EQU1403	.	.	.	EPS
----	EQU	EQU1404	-290.0000	-290.0000	-290.0000	EPS
----	EQU	EQU1405	.	.	.	793.7703
----	EQU	EQU1406	.	.	.	481.7180
----	EQU	EQU1407	.	.	.	494.4817
----	EQU	EQU1408	.	.	.	48.6685

\_Economic Optimization Program

05/15/01 16:49:39 PAGE 140  
GAMS 2.50A Windows NT/95/98

	LOWER	LEVEL	UPPER	MARGINAL		
----	EQU	EQU1409	.	.	.	0.0053
----	EQU	EQU1410	.	.	.	2.2004
----	EQU	EQU1411	.	.	.	4.2006
----	EQU	EQU1412	.	.	.	EPS
----	EQU	EQU1413	.	.	.	1.9250
----	EQU	EQU1414	.	.	.	2.3662
----	EQU	EQU1415	.	.	.	4.0239
----	EQU	EQU1416	.	.	.	-0.0017
----	EQU	EQU1417	.	.	.	118.6970
----	EQU	EQU1418	.	.	.	-5.9964
----	EQU	EQU1419	.	.	.	0.0525
----	EQU	EQU1420	.	.	.	-10.3647
----	EQU	EQU1421	.	.	.	1.2891
----	EQU	EQU1422	414.6000	414.6000	414.6000	-0.1533
----	EQU	EQU1423	.	.	.	1.1052
----	EQU	EQU1424	.	.	.	-9.0156
----	EQU	EQU1425	.	.	.	-0.0263
----	EQU	EQU1426	.	.	.	0.0005
----	EQU	EQU1427	.	.	.	-16.4464
----	EQU	EQU1428	.	.	.	24.7479
----	EQU	EQU1429	.	.	.	-0.1655
----	EQU	EQU1430	.	.	.	-0.5560
----	EQU	EQU1431	.	.	.	-0.4640
----	EQU	EQU1432	.	.	.	2.1256
----	EQU	EQU1433	.	.	.	1.7610
----	EQU	EQU1434	.	.	.	36.3474
----	EQU	EQU1435	.	.	.	0.4433
----	EQU	EQU1436	.	.	.	204.9417
----	EQU	EQU1437	.	.	.	54.7890
----	EQU	EQU1438	.	.	.	-0.0032
----	EQU	EQU1439	.	.	.	EPS
----	EQU	EQU1440	.	.	.	EPS
----	EQU	EQU1441	.	.	.	EPS
----	EQU	EQU1442	.	.	.	21.4095
----	EQU	EQU1443	.	.	.	-0.0103
----	EQU	EQU1444	.	.	.	38.3817
----	EQU	EQU1445	.	.	.	EPS
----	EQU	EQU1446	.	.	.	330.2436
----	EQU	EQU1447	.	.	.	EPS
----	EQU	EQU1448	.	.	.	339.8641
----	EQU	EQU1449	.	.	.	541.6731
----	EQU	EQU1450	.	.	.	544.0991
----	EQU	EQU1451	.	.	.	-561.6332
----	EQU	EQU1452	.	.	.	24.2424

\_Economic Optimization Program

05/15/01 16:49:39 PAGE 141  
GAMS 2.50A Windows NT/95/98

	LOWER	LEVEL	UPPER	MARGINAL		
----	EQU	EQU1453	.	.	.	0.0224
----	EQU	EQU1454	.	.	.	0.0013
----	EQU	EQU1455	.	.	.	EPS
----	EQU	EQU1456	.	.	.	EPS
----	EQU	EQU1457	.	.	.	EPS
----	EQU	EQU1458	.	.	.	EPS
----	EQU	EQU1459	.	.	.	20.0818
----	EQU	EQU1460	.	.	.	23.2009
----	EQU	EQU1461	.	.	.	7.1635
----	EQU	EQU1462	.	.	.	EPS

```

---- EQU EQU1463      .      .      .      0.0078
---- EQU EQU1464      .      .      .      EPS
---- EQU EQU1465      .      .      .      -0.1746
---- EQU EQU1466      .      .      .      0.0443
---- EQU EQU1467      .      .      .      2.9517
---- EQU EQU1468      1.0000    1.0000    1.0000    -0.2553
---- EQU EQU1469      .      .      .      -0.0033
---- EQU EQU1470      .      .      .      -0.0033
---- EQU EQU1471      1.0000    1.0000    1.0000    -0.0241
---- EQU EQU1472      .      .      .      EPS
---- EQU EQU1473      1.0000    1.0000    1.0000    .
---- EQU EQU1474      .      .      .      EPS
---- EQU EQU1475      .      .      .      EPS
---- EQU EQU1476      1.0000    1.0000    1.0000    .
---- EQU EQU1477      .      .      .      -8.0171
---- EQU EQU1478      .      .      .      EPS
---- EQU EQU1479      .      .      .      -0.7515
---- EQU EQU1480      .      .      .      -5.6930
---- EQU EQU1481      1.0000    1.0000    1.0000    9.3606
---- EQU EQU1482      .      .      .      -3.4279
---- EQU EQU1483      .      .      .      EPS
---- EQU EQU1484      .      .      .      -5.7204
---- EQU EQU1485      .      .      .      -0.0014
---- EQU EQU1486      .      .      .      332.8291
---- EQU EQU1487      1.0000    1.0000    1.0000    -0.8828
---- EQU EQU1488      .      .      .      EPS
---- EQU EQU1489      .      .      .      EPS
---- EQU EQU1490      .      .      .      -1.708206E-5
---- EQU EQU1491      .      .      .      -5.979112E-6
---- EQU EQU1492      1.0000    1.0000    1.0000    5.6781
---- EQU EQU1493      .      .      .      -5.4814
---- EQU EQU1494      1.0000    1.0000    1.0000    35.5543
---- EQU EQU1495      1.0000    1.0000    1.0000    -0.9137
---- EQU EQU1496      .      .      .      -6.015542E-5

```

\_Economic Optimization Program

05/15/01 16:49:39 PAGE 142  
GAMS 2.50A Windows NT/95/98

```

          LOWER      LEVEL      UPPER      MARGINAL
---- EQU EQU1497      1.0000    1.0000    1.0000    5.3433
---- EQU EQU1498      .      .      .      182.6973
---- EQU EQU1499      .      .      .      -3.7959
---- EQU EQU1500      .      .      .      -0.6435
---- EQU EQU1501      .      .      .      EPS
---- EQU EQU1502      .      .      .      -0.0007
---- EQU EQU1503      .      .      .      -17.2225
---- EQU EQU1504      .      .      .      -5.0672
---- EQU EQU1505      .      .      .      -3.5676
---- EQU EQU1506      .      .      .      -0.0007
---- EQU EQU1507      .      .      .      -0.9425
---- EQU EQU1508      1.0000    1.0000    1.0000    .
---- EQU EQU1509      .      .      .      -0.0068
---- EQU EQU1510      .      .      .      -0.0002
---- EQU EQU1511      .      .      .      EPS
---- EQU EQU1512      .      .      .      -0.0258
---- EQU EQU1513      1.0000    1.0000    1.0000    -35.7349
---- EQU EQU1514      .      .      .      -0.2124
---- EQU EQU1515      1.0000    1.0000    1.0000    7.8830
---- EQU EQU1516      .      .      .      0.0415
---- EQU EQU1517      1.0000    1.0000    1.0000    181.1745
---- EQU EQU1518      .      .      .      EPS
---- EQU EQU1519      .      .      .      0.1709
---- EQU EQU1520      1.0000    1.0000    1.0000    -241.7364
---- EQU EQU1521      .      .      .      0.0291
---- EQU EQU1522      1.0000    1.0000    1.0000    -7.6874
---- EQU EQU1523      .      .      .      -0.0291
---- EQU EQU1524      .      .      .      -7.9697
---- EQU EQU1525      .      .      .      -7.7259
---- EQU EQU1526      .      .      .      -1.0000
---- EQU EQU1527      .      .      .      1.0000
---- EQU EQU1528      6.8883    6.8883    6.8883    -1.0000
---- EQU EQU1529      .      .      .      1.0000
---- EQU EQU1530      .      .      .      EPS
---- EQU EQU1531      .      .      .      0.0074
---- EQU EQU1532      .      .      .      0.0258
---- EQU EQU1533      .      .      .      0.0325
---- EQU EQU1534      .      .      .      2.9778
---- EQU EQU1535      .      .      .      92.2780
---- EQU EQU1536      .      .      .      -0.9549
---- EQU EQU1537      .      .      .      -42.7343
---- EQU EQU1538      .      .      .      0.0291
---- EQU EQU1539      .      .      .      -0.2000
---- EQU EQU1540      .      .      .      -0.0001

```

\_Economic Optimization Program

05/15/01 16:49:39 PAGE 143  
GAMS 2.50A Windows NT/95/98

```

          LOWER      LEVEL      UPPER      MARGINAL
---- EQU EQU1541      .      .      .      1.3434
---- EQU EQU1542      .      .      .      3.9985

```

----	EQU	EQU1543	.	.	.	.	-4.5809	
----	EQU	EQU1544	.	.	.	.	-0.1831	
----	EQU	EQU1545	.	.	.	.	1.4141	
----	EQU	EQU1546	.	.	.	.	-0.0641	
----	EQU	EQU1547	.	.	.	.	36.7162	
----	EQU	EQU1548	.	.	.	.	EPS	
----	EQU	EQU1549	.	.	.	.	EPS	
----	EQU	EQU1550	.	.	.	.	544.0439	
----	EQU	EQU1551	.	.	.	.	3.4597	
----	EQU	EQU1552	.	.	.	.	EPS	
----	EQU	EQU1553	.	.	.	.	EPS	
----	EQU	EQU1554	.	.	.	.	-1.5748	
----	EQU	EQU1555	.	.	.	.	EPS	
----	EQU	EQU1556	.	.	.	.	EPS	
----	EQU	EQU1557	.	.	.	.	510.2405	
----	EQU	EQU1558	10.2210	10.2210	10.2210	10.2210	-2.2002	
----	EQU	EQU1559	10.2210	10.2210	10.2210	10.2210	EPS	
----	EQU	EQU1560	.	.	.	.	EPS	
----	EQU	EQU1561	.	.	.	.	EPS	
----	EQU	EQU1562	.	.	.	.	-4.2202	
----	EQU	EQU1563	.	.	.	.	544.0292	
----	EQU	EQU1564	.	.	.	.	EPS	
----	EQU	EQU1565	10.2210	10.2210	10.2210	10.2210	-0.0129	
----	EQU	EQU1566	10.2210	10.2210	10.2210	10.2210	-19.2382	
----	EQU	EQU1567	10.2210	10.2210	10.2210	10.2210	-0.9495	
----	EQU	EQU1568	10.2210	10.2210	10.2210	10.2210	-0.1865	
----	EQU	EQU1569	.	.	.	.	95.3695	
----	EQU	EQU1570	.	.	.	.	47.8879	
----	EQU	EQU1571	.	.	.	.		
----	EQU	EQU1572	.	.	.	.	213.7931	
----	EQU	EQU1573	.	.	.	.	EPS	
----	EQU	EQU1574	.	.	.	.	EPS	
----	EQU	EQU1575	.	.	.	.	1.2321	
----	EQU	EQU1576	.	.	.	.	0.8346	
----	EQU	EQU1577	.	.	.	.	EPS	
----	EQU	EQU1578	.	.	.	.	EPS	
----	EQU	EQU1579	.	.	.	.	EPS	
----	EQU	INEQU1	-INF	0.0759	1.0000			
----	EQU	INEQU2	8.0000	8.4588	+INF			
----	EQU	INEQU3	10.0000	12.0087	+INF			
----	EQU	INEQU4	10.0000	13.8440	+INF			
----	EQU	INEQU5	10.0000	14.1458	+INF			

\_Economic Optimization Program

05/15/01 16:49:39 PAGE 144  
GAMS 2.50A Windows NT/95/98

	LOWER	LEVEL	UPPER	MARGINAL		
----	EQU	INEQU6	300.0000	300.0000	+INF	-0.0008
----	EQU	INEQU7	10.0000	24.2003	+INF	.
----	EQU	INEQU8	-404.6000	-359.0690	+INF	.
----	EQU	INEQU9	-404.6000	-359.0690	+INF	.
----	EQU	INEQU10	300.0000	322.5997	+INF	.
----	EQU	INEQU11	10.0000	10.0000	+INF	-0.0409
----	EQU	INEQU12	10.0000	104.7508	+INF	.
----	EQU	INEQU13	10.0000	93.2720	+INF	.
----	EQU	INEQU14	300.0000	303.5753	+INF	.
----	EQU	INEQU15	10.0000	69.9127	+INF	.
----	EQU	INEQU16	300.0000	337.0859	+INF	.
----	EQU	INEQU17	10.0000	10.4340	+INF	.
----	EQU	INEQU18	300.0000	307.2720	+INF	.
----	EQU	INEQU19	10.0000	39.0859	+INF	.
----	EQU	INEQU20	300.0000	304.5245	+INF	.
----	EQU	INEQU21	10.0000	12.1433	+INF	.
----	EQU	INEQU22	10.0000	12.3580	+INF	.
----	EQU	INEQU23	10.0000	10.0000	+INF	-0.0035
----	EQU	INEQU24	298.0000	363.3260	+INF	.
----	EQU	INEQU25	8.0000	68.3260	+INF	.
----	EQU	INEQU26	8.0000	8.0000	+INF	-0.7971
----	EQU	INEQU27	8.0000	12.1637	+INF	.
----	EQU	INEQU28	8.0000	8.4331	+INF	.
----	EQU	INEQU29	8.0000	8.2197	+INF	.
----	EQU	INEQU30	8.0000	16.0857	+INF	.
----	EQU	INEQU31	298.0000	328.4033	+INF	.
----	EQU	INEQU32	10.0000	12.0087	+INF	.
----	EQU	INEQU33	300.0000	328.4033	+INF	.
----	EQU	INEQU34	10.0000	10.0000	+INF	EPS
----	EQU	INEQU35	10.0000	10.0000	+INF	-0.0020
----	EQU	INEQU36	-471.0000	-405.0000	+INF	.
----	EQU	INEQU37	-471.0000	-460.9878	+INF	.
----	EQU	INEQU38	-404.6000	-363.3260	+INF	.
----	EQU	INEQU39	-404.6000	-403.7525	+INF	.
----	EQU	INEQU40	10.0000	12.1921	+INF	.
----	EQU	INEQU41	10.0000	13.7160	+INF	.
----	EQU	INEQU42	-404.6000	-336.6046	+INF	.
----	EQU	INEQU43	-404.6000	-336.6046	+INF	.
----	EQU	INEQU44	10.0000	10.0000	+INF	-0.2615
----	EQU	INEQU45	300.0000	300.0000	+INF	.
----	EQU	INEQU46	10.0000	13.0955	+INF	.
----	EQU	INEQU47	300.0000	318.7440	+INF	.
----	EQU	INEQU48	10.0000	10.5454	+INF	.
----	EQU	INEQU49	300.0000	300.0000	+INF	-0.0012

	LOWER	LEVEL	UPPER	MARGINAL
---- EQU INEQU50	-INF	.	0.0001	.
---- EQU OBJNAME	.	.	.	1.0000
	LOWER	LEVEL	UPPER	MARGINAL
---- VAR FAC02	0.0900	0.1600	0.1600	374.0119
---- VAR FAC12	0.0100	0.1600	0.9000	.
---- VAR FAC23	0.0100	0.1600	0.9000	.
---- VAR FAC34	0.0100	0.1600	0.9000	.
---- VAR FAC45	0.0100	0.1600	0.9000	.
---- VAR FC308	1.0000	3.1197	6.0000	.
---- VAR FC316	0.1000	1.7518	1.8000	.
---- VAR FC320	0.0100	0.0459	1.5000	.
---- VAR FC322	0.1000	1.5684	1.6000	.
---- VAR FC328	0.0100	0.0545	1.0000	.
---- VAR FC329	0.1000	0.7635	3.0000	.
---- VAR FC403	0.1000	2.3677	5.0000	.
---- VAR FC407	0.7500	0.9348	5.0000	.
---- VAR FC412	0.0100	0.0420	1.0000	.
---- VAR FC417	0.1000	0.1439	2.0000	.
---- VAR FHC01	0.7950	0.8979	1.5000	.
---- VAR FHC32	0.5000	1.9569	5.0000	.
---- VAR FSC402	0.1000	0.4587	4.0000	.
---- VAR FSC405	.	0.3148	3.0000	.
---- VAR FSC411	0.1000	1.3267	3.2000	.
---- VAR FSC413	0.1000	0.1439	0.5000	.
---- VAR FSTME612	0.0500	0.0888	1.0000	.
---- VAR PC302	101.0000	101.0000	187.0000	-0.0008
---- VAR PC310	230.0000	260.0000	360.0000	.
---- VAR PC601	600.0000	625.0000	625.0000	0.0195
---- VAR PC603	1600.0000	1691.3731	1800.0000	.
---- VAR QHC07	0.1000	1.9469	5.0000	.
---- VAR QHC11	0.1000	1.7391	5.0000	.
---- VAR QHC14	0.1000	1.7391	5.0000	.
---- VAR QHC16	0.1000	1.7391	5.0000	.
---- VAR QHC34	0.1000	1.1464	5.0000	.
---- VAR QHC38	0.1000	0.5352	5.0000	.
---- VAR QHC41	0.1000	0.8699	5.0000	.
---- VAR QHC45	0.1000	0.8518	5.0000	.
---- VAR TAC09	280.0000	280.0000	300.0000	-0.0036
---- VAR TAC12	280.0000	280.0000	300.0000	.
---- VAR TAC23	280.0000	280.0000	300.0000	.
---- VAR TAC31	280.0000	280.0000	300.0000	-0.0010
---- VAR TAC34	280.0000	280.0000	300.0000	.

	LOWER	LEVEL	UPPER	MARGINAL
---- VAR TAC42	280.0000	280.0000	300.0000	-0.0030
---- VAR TAC45	280.0000	280.0000	300.0000	.
---- VAR TC303	260.0000	280.6862	300.0000	.
---- VAR TC306	320.0000	349.4271	368.0000	.
---- VAR TC307	300.0000	328.4033	330.0000	.
---- VAR TC308	270.0000	328.4033	350.0000	.
---- VAR TC315	300.0000	307.3612	320.0000	.
---- VAR TC316	335.0000	345.2250	370.0000	.
---- VAR TC317	300.0000	359.0690	420.0000	.
---- VAR TC321	250.0000	300.0000	350.0000	.
---- VAR TC324	359.0000	359.0690	385.0000	.
---- VAR TC325	300.0000	322.5997	360.0000	.
---- VAR TC404	305.0000	305.2492	325.0000	.
---- VAR TC405	410.0000	410.0000	440.0000	-0.0269
---- VAR TC407	298.0000	303.5753	350.0000	.
---- VAR TC408	405.0000	405.0000	440.0000	-0.8220
---- VAR TC410	345.0000	363.3260	369.0000	.
---- VAR TC414	300.0000	337.0859	368.0000	.
---- VAR TC418	301.0000	307.1433	350.0000	.
---- VAR TC419	298.0000	304.5245	310.0000	.
---- VAR THC32	250.0000	261.9077	310.0000	.
---- VAR TSC402	310.0000	322.8886	340.0000	.
---- VAR TSC403	320.0000	336.6046	350.0000	.
---- VAR TSC405	300.0000	300.0000	360.0000	-0.4217
---- VAR TSC408	300.0000	318.7440	330.0000	.
---- VAR TSC413	295.0000	300.0000	350.0000	.
---- VAR X11AC12	0.8800	0.9687	0.9990	.
---- VAR X11AC23	0.8800	0.9424	0.9990	.
---- VAR X11AC34	0.8800	0.9162	0.9990	.
---- VAR X11AC45	0.8800	0.8900	0.9990	.
---- VAR X1C316	0.0100	0.1166	0.5000	.
---- VAR X1C325	0.5000	1.0000	1.0000	.
---- VAR X1C417	0.0200	0.0200	0.2000	-52.0438
---- VAR X1HC32	.	0.0228	0.1000	.
---- VAR X1SC402	.	0.0063	0.1000	.
---- VAR X1SC403	.	.	0.1000	.

```

---- VAR X1SC408 . 0.0200 0.1000 .
---- VAR X2SC402 . . 0.1000 .
---- VAR X2SC403 . . 0.1000 -13.6611
---- VAR X2SC408 . . 0.1000 .
---- VAR X3C316 0.5000 0.7851 1.0000 .
---- VAR X3C325 . 1.5978930E-6 0.1000 .
---- VAR X3C417 0.3500 0.9738 1.0000 .
---- VAR X3HC32 0.1000 0.7604 1.0000 .
_Economic Optimization Program

```

05/15/01 16:49:39 PAGE 147  
GAMS 2.50A Windows NT/95/98

```

          LOWER      LEVEL      UPPER      MARGINAL
---- VAR X3SC402      0.2000      0.3216      0.4200      .
---- VAR X3SC403      . 0.0234      0.1000      .
---- VAR X3SC408      0.5000      0.9739      1.0000      .
---- VAR X4C316      0.0010      0.0894      0.2000      .
---- VAR X4C417      0.0010      0.0061      0.4000      .
---- VAR X4HC32      . 0.1401      0.5000      .
---- VAR X4SC402      0.4800      0.5280      0.7000      .
---- VAR X4SC403      0.5000      0.7666      1.0000      .
---- VAR X4SC408      . 0.0061      0.1000      .
---- VAR X5C316      . 0.0056      0.0100      .
---- VAR X5C417      . 3.3333334E-5      0.1500      .
---- VAR X5HC32      . 0.0288      2.5000      .
---- VAR X5SC402      . 0.0686      0.1000      .
---- VAR X5SC403      . 0.1000      0.1000      .
---- VAR X5SC408      . . 0.1000      .
---- VAR X6SC402      . 0.0686      0.1000      .
---- VAR X6SC403      . 0.1000      0.1200      .
---- VAR X6SC408      . . 0.1000      .
---- VAR X7HC32      . 0.0479      2.0000      .
---- VAR X7SC402      . 0.0069      0.1000      .
---- VAR X7SC403      . 0.0100      0.1000      .
---- VAR X7SC408      . . 0.1000      .
---- VAR XX1C322      . 0.1133      0.1200      .
---- VAR XX1C414      . 0.0762      0.0800      .
---- VAR XX1HC01      . 0.0976      0.5000      .
---- VAR XX2HC01      0.1000      0.1296      0.6000      .
---- VAR XX3C317      0.5000      0.7900      1.0000      .
---- VAR XX3C322      0.5000      0.7900      1.0000      .
---- VAR XX3C407      . 2.3780783E-5      0.1000      .
---- VAR XX3C412      . 0.0021      0.1500      .
---- VAR XX3C414      0.5000      0.8081      1.0000      .
---- VAR XX3HC01      . 0.0125      0.5500      .
---- VAR XX4C317      . 0.0899      0.2000      .
---- VAR XX4C322      . 0.0899      0.2000      .
---- VAR XX4C407      0.0100      0.0851      0.3000      .
---- VAR XX4C412      0.5000      0.8771      1.0000      .
---- VAR XX4C414      . 0.1067      0.2000      .
---- VAR XX4HC01      . 0.1108      0.3000      .
---- VAR XX5C407      0.0100      0.1512      0.5000      .
---- VAR XX5C412      . 0.0568      0.1000      .
---- VAR XX5C414      . 0.0010      0.1000      .
---- VAR XX7C414      . 0.0080      0.0080      1021.4560
---- VAR OBJVAR      -INF      29.1128      +INF
---- VAR C10PC623      . 3.8395828E-5      0.5000      .
_Economic Optimization Program

```

05/15/01 16:49:39 PAGE 148  
GAMS 2.50A Windows NT/95/98

```

          LOWER      LEVEL      UPPER      MARGINAL
---- VAR C10PC625      . 7.7797929E-5      0.5000      .
---- VAR C10PC627      . 0.0002      0.5000      .
---- VAR C10PC629      . 0.0002      0.5000      .
---- VAR C2C623      . 0.0165      0.1000      .
---- VAR C2C625      . 0.0151      0.1000      .
---- VAR C2C627      . 0.0148      0.1000      .
---- VAR C2C629      . 0.0152      0.1000      .
---- VAR C3C623      . 3.9512      6.0000      .
---- VAR C3C625      . 2.5135      6.0000      .
---- VAR C3C627      . 1.4717      6.0000      .
---- VAR C3C629      . 1.7742      6.0000      .
---- VAR C3PC623      . 1.2420      10.0000      .
---- VAR C3PC625      . 1.1980      10.0000      .
---- VAR C3PC627      . 1.2165      10.0000      .
---- VAR C3PC629      . 1.1915      10.0000      .
---- VAR C4PC623      . 0.0276      1.0000      .
---- VAR C4PC625      . 0.0418      1.0000      .
---- VAR C4PC627      . 0.0726      1.0000      .
---- VAR C4PC629      . 0.0589      1.0000      .
---- VAR C5PC623      . 0.0004      0.1000      .
---- VAR C5PC625      . 0.0010      0.1000      .
---- VAR C5PC627      . 0.0028      0.1000      .
---- VAR C5PC629      . 0.0019      0.1000      .
---- VAR C7PC623      . 4.1042795E-5      0.1000      .
---- VAR C7PC625      . 0.0002      0.1000      .
---- VAR C7PC627      . 0.0016      0.1000      .
---- VAR C7PC629      . 0.0008      0.1000      .
---- VAR C8PC623      . 0.0016      0.1000      .

```

----	VAR C8PC625	.	0.0035	0.1000	.
----	VAR C8PC627	.	0.0099	0.1000	.
----	VAR C8PC629	.	0.0069	0.1000	.
----	VAR C9PC623	.	0.4585	10.0000	.
----	VAR C9PC625	.	0.6434	10.0000	.
----	VAR C9PC627	.	1.0975	10.0000	.
----	VAR C9PC629	.	0.9108	10.0000	.
----	VAR CHXC623	2.5000	13.4316	15.0000	.
----	VAR CHXC625	2.5000	14.2010	15.0000	.
----	VAR CHXC627	2.5000	14.6961	15.0000	.
----	VAR CHXC629	2.5000	14.0353	15.0000	.
----	VAR CIC10PC623	.	.	1.0000	.
----	VAR CIC10PC625	.	.	1.0000	.
----	VAR CIC10PC627	.	.	1.0000	.
----	VAR CIC10PC629	.	.	1.0000	.
----	VAR CIC11PC623	.	1.4680088E-5	0.1000	.

\_Economic Optimization Program

05/15/01 16:49:39 PAGE 149  
GAMS 2.50A Windows NT/95/98

	LOWER	LEVEL	UPPER	MARGINAL	
----	VAR CIC11PC625	.	4.5601952E-5	0.1000	.
----	VAR CIC11PC627	.	0.0002	0.1000	.
----	VAR CIC11PC629	.	0.0001	0.1000	.
----	VAR CIC4EC623	.	0.0031	0.1000	.
----	VAR CIC4EC625	.	0.0031	0.1000	.
----	VAR CIC4EC627	.	0.0031	0.1000	.
----	VAR CIC4EC629	.	0.0031	0.1000	.
----	VAR CIC5EC623	.	0.0007	0.1000	.
----	VAR CIC5EC625	.	0.0009	0.1000	.
----	VAR CIC5EC627	.	0.0014	0.1000	.
----	VAR CIC5EC629	.	0.0013	0.1000	.
----	VAR CIC8EC623	.	0.0183	0.3000	.
----	VAR CIC8EC625	.	0.0267	0.3000	.
----	VAR CIC8EC627	.	0.0448	0.3000	.
----	VAR CIC8EC629	.	0.0380	0.3000	.
----	VAR COST	-10000.0000	144.2870	10000.0000	.
----	VAR DTE601	5.0000	12.9391	50.0000	.
----	VAR DTE602	5.0000	77.9954	90.0000	.
----	VAR DTE603	5.0000	10.0000	50.0000	.
----	VAR DTE605	5.0000	20.9198	50.0000	.
----	VAR DTE609A	5.0000	10.2703	20.0000	.
----	VAR DTE610	5.0000	13.9944	50.0000	.
----	VAR DTE611	5.0000	16.0549	50.0000	.
----	VAR DTE612	10.0000	55.5310	90.0000	.
----	VAR DTE613	4.0000	21.2999	30.0000	.
----	VAR DTE616	10.0000	98.9004	120.0000	.
----	VAR DTE617	5.0000	34.0905	50.0000	.
----	VAR DTE621A	5.0000	28.7599	50.0000	.
----	VAR DTE621B	5.0000	26.6950	40.0000	.
----	VAR DTE626	5.0000	13.2984	50.0000	.
----	VAR DTE627A	5.0000	55.0000	55.0000	0.5475
----	VAR DTE627B	5.0000	31.5672	50.0000	.
----	VAR DTE628	5.0000	11.1374	60.0000	.
----	VAR DTE629	5.0000	17.3923	80.0000	.
----	VAR DTE633	5.0000	12.1527	50.0000	.
----	VAR DTE634	5.0000	19.6708	20.0000	.
----	VAR DTE640	5.0000	20.7286	50.0000	.
----	VAR DTE641	5.0000	16.3756	50.0000	.
----	VAR DTE695A	5.0000	76.0000	90.0000	.
----	VAR DTE695B	5.0000	48.0061	60.0000	.
----	VAR DTE696A	10.0000	51.2740	90.0000	.
----	VAR DTE696B	10.0000	31.0608	90.0000	.
----	VAR DTE6XX	1.0000	1.1787	50.0000	.
----	VAR EARNINGS	-10000.0000	181.6027	10000.0000	.

\_Economic Optimization Program

05/15/01 16:49:39 PAGE 150  
GAMS 2.50A Windows NT/95/98

	LOWER	LEVEL	UPPER	MARGINAL	
----	VAR F1C601	.	0.1000	-0.2745	.
----	VAR F1C603	.	0.7330	1.0000	.
----	VAR F1C606A	.	0.0100	1.0000	.
----	VAR F2C601	0.5000	0.9941	1.0000	.
----	VAR F3C601	0.0500	0.0500	1.0000	-13.7780
----	VAR F3C603	.	1.0000	1.0000	.
----	VAR F3C606A	.	0.0025	1.0000	.
----	VAR F4C601	0.9500	0.9964	1.0000	.
----	VAR F4C603	.	1.0000	1.0000	.
----	VAR F4C606A	.	0.8876	1.0000	.
----	VAR F5C601	0.5000	1.0000	1.0000	.
----	VAR F5C603	0.5000	1.0000	1.0000	.
----	VAR F5C606A	0.5000	0.9886	1.0000	.
----	VAR F6C601	0.5000	1.0000	1.0000	.
----	VAR F7C601	0.5000	1.0000	1.0000	.
----	VAR F7C603	0.5000	1.0000	1.0000	.
----	VAR F7C606A	0.5000	0.9993	1.0000	.
----	VAR FAC05	0.1000	6.9259	20.0000	.
----	VAR FAC07	0.1000	7.0859	20.0000	.
----	VAR FAC09	0.0100	8.8646	20.0000	.

----	VAR FAC15	0.1000	8.4886	20.0000	.
----	VAR FAC18	0.1000	8.6486	20.0000	.
----	VAR FAC20	0.0100	9.9564	20.0000	.
----	VAR FAC26	0.1000	18.2520	20.0000	.
----	VAR FAC29	0.1000	18.4120	20.0000	.
----	VAR FAC31	0.0100	19.9121	20.0000	.
----	VAR FAC37	0.1000	14.7376	20.0000	.
----	VAR FAC40	0.1000	14.8976	20.0000	.
----	VAR FAC42	0.0100	16.3873	20.0000	.
----	VAR FC301	1.0000	3.7087	6.0000	.
----	VAR FC302	0.1000	0.3807	5.0000	.
----	VAR FC303	2.0000	4.0893	6.0000	.
----	VAR FC306	0.1000	4.8715	15.0000	.
----	VAR FC307	0.0001	4.8715	15.0000	.
----	VAR FC309	0.0001	3.1197	10.0000	.
----	VAR FC310	0.0001	0.7821	3.0000	.
----	VAR FC311	.	2.3375	8.0000	.
----	VAR FC312	0.0001	1.7518	5.0000	.
----	VAR FC315	0.0001	1.7518	5.0000	.
----	VAR FC317	0.1000	1.6973	3.0000	.
----	VAR FC318	0.0001	1.6973	3.0000	.
----	VAR FC319	0.0001	1.6973	3.0000	.
----	VAR FC321	.	0.0830	5.0000	.
----	VAR FC323	0.5000	0.8012	3.0000	.

\_Economic Optimization Program

05/15/01 16:49:39 PAGE 151  
GAMS 2.50A Windows NT/95/98

	LOWER	LEVEL	UPPER	MARGINAL	
----	VAR FC324	0.5000	0.8012	3.0000	.
----	VAR FC325	0.5000	0.8181	3.0000	.
----	VAR FC326	0.0100	0.8181	3.0000	.
----	VAR FC401	0.1000	2.3677	5.0000	.
----	VAR FC402	0.1000	2.3677	5.0000	.
----	VAR FC404	.	2.3677	5.0000	.
----	VAR FC405	0.1000	0.9348	2.0000	.
----	VAR FC406	.	0.9348	5.0000	.
----	VAR FC408	.	3.2323	10.0000	.
----	VAR FC409	.	3.2323	10.0000	.
----	VAR FC410	0.1000	0.8605	10.0000	.
----	VAR FC411	.	0.8605	10.0000	.
----	VAR FC413	.	0.0420	1.0000	.
----	VAR FC414	0.1000	2.9946	5.0000	.
----	VAR FC415	.	2.9946	10.0000	.
----	VAR FC418	0.1000	3.1385	5.0000	.
----	VAR FC419	0.0001	3.1385	10.0000	.
----	VAR FC425	1.0000	3.9120	10.0000	.
----	VAR FC426	.	3.0516	5.0000	.
----	VAR FC427	.	2.9772	10.0000	.
----	VAR FC428	.	2.1168	5.0000	.
----	VAR FC430	1.0000	3.9120	10.0000	.
----	VAR FC431	.	2.9772	10.0000	.
----	VAR FC432	1.0000	2.9352	5.0000	.
----	VAR FCWE603	0.1000	0.1864	20.0000	.
----	VAR FCWE605	0.1000	6.7919	15.0000	.
----	VAR FCWE609A	0.0100	0.0887	1.0000	.
----	VAR FCWE611	0.1000	3.0202	20.0000	.
----	VAR FCWE613	0.1000	2.4810	15.0000	.
----	VAR FCWE617	1.0000	1.5510	25.0000	EPS
----	VAR FCWE621A	0.1000	5.4552	10.0000	.
----	VAR FCWE621B	0.1000	6.9388	20.0000	.
----	VAR FCWE626	0.1000	0.9759	20.0000	.
----	VAR FCWE627A	0.1000	0.5522	10.0000	.
----	VAR FCWE627B	0.1000	0.5404	30.0000	.
----	VAR FCWE634	4.0000	7.2327	60.0000	.
----	VAR FCWE640	0.4000	0.4000	50.0000	-0.0208
----	VAR FCWE641A	0.1000	4.2849	30.0000	.
----	VAR FCWE641B	0.1000	0.9924	10.0000	.
----	VAR FHC02	0.0100	0.8979	5.0000	.
----	VAR FHC03	1.0000	3.2215	10.0000	.
----	VAR FHC04	1.0000	3.2215	10.0000	.
----	VAR FHC05	1.0000	3.2215	10.0000	.
----	VAR FHC06	1.0000	4.1195	12.0000	.

\_Economic Optimization Program

05/15/01 16:49:39 PAGE 152  
GAMS 2.50A Windows NT/95/98

	LOWER	LEVEL	UPPER	MARGINAL	
----	VAR FHC07	1.0000	1.1195	5.0000	.
----	VAR FHC08	1.0000	3.0000	5.0000	.
----	VAR FHC11	1.0000	1.0000	5.0000	-0.0308
----	VAR FHC14	1.0000	1.0000	5.0000	-0.0999
----	VAR FHC15	1.0000	2.0000	5.0000	.
----	VAR FHC16	1.0000	1.0000	5.0000	-0.1815
----	VAR FHC22	1.0000	1.4898	6.0000	.
----	VAR FHC23	1.0000	1.5002	6.0000	.
----	VAR FHC24	1.0000	2.9899	6.0000	.
----	VAR FHC25	1.0000	1.3078	6.0000	.
----	VAR FHC26	1.0000	4.2977	6.0000	.
----	VAR FHC27	1.0000	1.7787	10.0000	.

----	VAR FHC28	1.0000	6.0764	12.0000	.
----	VAR FHC29	.	1.2304	12.0000	.
----	VAR FHC30	.	1.2304	12.0000	.
----	VAR FHC31	.	6.0764	12.0000	.
----	VAR FHC33	.	0.9669	1.0000	.
----	VAR FHC34	.	0.6592	1.0000	.
----	VAR FHC38	.	0.3078	1.0000	.
----	VAR FHC40	.	0.9899	1.0000	.
----	VAR FHC41	.	0.5002	1.0000	.
----	VAR FHC45	.	0.4898	1.0000	.
----	VAR FLHC28	1.0000	3.1642	10.0000	.
----	VAR FLHC29	.	0.6407	12.0000	.
----	VAR FLHC30	.	0.4686	12.0000	.
----	VAR FLHC31	.	2.3677	12.0000	.
----	VAR FLR1	.	2.5234	10.0000	.
----	VAR FLR29	.	1.8991	12.0000	.
----	VAR FMC302	.	0.0067	0.1000	.
----	VAR FMC308	0.0001	0.0538	0.5000	.
----	VAR FMC310	.	0.0138	0.8000	.
----	VAR FMC311	.	0.0399	0.5000	.
----	VAR FMC312	.	0.0312	0.1000	.
----	VAR FMC317	0.0010	0.0300	0.1000	.
----	VAR FMC322	.	0.0277	1.0000	.
----	VAR FMC323	.	0.0141	0.4000	.
----	VAR FMC325	0.0100	0.0185	1.0000	.
----	VAR FMC405	.	0.0114	0.1000	.
----	VAR FMC407	.	0.0114	0.1000	.
----	VAR FMC408	.	0.0396	2.0000	.
----	VAR FMC409	.	0.0396	0.2000	.
----	VAR FMC412	.	0.0007	0.1000	.
----	VAR FMC414	0.0001	0.0523	0.1000	.
----	VAR FMC425	.	0.0580	2.0000	.

\_Economic Optimization Program

05/15/01 16:49:39 PAGE 153  
GAMS 2.50A Windows NT/95/98

	LOWER	LEVEL	UPPER	MARGINAL	
----	VAR FMC427	.	0.0466	0.2000	.
----	VAR FMC428	.	0.0338	0.1000	.
----	VAR FMC430	.	0.0605	0.2000	.
----	VAR FMC431	.	0.0491	1.0000	.
----	VAR FMC432	.	0.0484	0.1000	.
----	VAR FMHC01	.	0.0124	0.1000	.
----	VAR FMHC32	.	0.0332	0.1000	.
----	VAR FMLHC28	0.0100	0.0498	0.2000	.
----	VAR FMLHC29	.	0.0101	0.1000	.
----	VAR FMLHC30	.	0.0072	0.1000	.
----	VAR FMLR1	.	0.0397	0.2000	.
----	VAR FMLR29	.	0.0291	0.1000	.
----	VAR FMSC403	0.0010	0.0052	0.1000	.
----	VAR FMSC406	.	0.0242	0.1000	.
----	VAR FMSC408	.	0.0255	1.0000	.
----	VAR FMVHC28	.	0.0509	0.2000	.
----	VAR FMVHC29	.	0.0103	0.1000	.
----	VAR FMVHC30	.	0.0132	0.1000	.
----	VAR FMVR1	.	0.0406	0.2000	.
----	VAR FMVR29	.	0.0512	0.1000	.
----	VAR FR1	.	4.8460	12.0000	.
----	VAR FR29	.	4.8460	12.0000	.
----	VAR FSC401	0.1000	0.4587	5.0000	.
----	VAR FSC403	0.1000	0.3148	3.0000	.
----	VAR FSC404	0.1000	0.3148	3.0000	.
----	VAR FSC406	.	1.4706	3.0000	.
----	VAR FSC407	.	1.4706	3.0000	.
----	VAR FSC408	0.0500	1.4706	3.2000	.
----	VAR FSC409	0.0500	1.4706	3.2000	.
----	VAR FSC412	0.1020	0.1439	1.0000	.
----	VAR FSC414	.	4.7975272E-5	0.5000	.
----	VAR FSTME602	0.1000	0.2118	1.0000	.
----	VAR FSTME695A	.	0.4038	10.0000	.
----	VAR FSTME695B	0.1000	0.1000	10.0000	-340.5316
----	VAR FSTME696A	0.0100	0.1142	10.0000	.
----	VAR FSTME696B	0.0100	0.0190	10.0000	.
----	VAR FVHC28	.	2.9122	8.0000	.
----	VAR FVHC29	.	0.5897	12.0000	.
----	VAR FVHC30	.	0.7618	12.0000	.
----	VAR FVHC31	.	3.7087	12.0000	.
----	VAR FVR1	.	2.3225	12.0000	.
----	VAR FVR29	.	2.9468	12.0000	.
----	VAR H1C601	0.8000	1.0638	2.0000	.
----	VAR H1C603	-3.0000	-0.3655	1.0000	.

\_Economic Optimization Program

05/15/01 16:49:39 PAGE 154  
GAMS 2.50A Windows NT/95/98

	LOWER	LEVEL	UPPER	MARGINAL	
----	VAR H1C606A	.	0.9921	10.0000	.
----	VAR H2C601	0.3950	0.6979	5.0000	.
----	VAR H3C601	0.5000	2.2985	6.0000	.
----	VAR H3C603	.	0.2650	1.0000	.



----	VAR H3C606A	-65.0000	-65.0000	-35.0000	-0.0002
----	VAR H4C601	0.4500	0.7114	2.0000	
----	VAR H4C603		0.3365	1.0000	
----	VAR H4C606A	-10.0000	-5.99963E-20	1.0000	
----	VAR H5C601	0.5000	0.9443	1.5000	
----	VAR H5C603		0.4400	1.5000	
----	VAR H5C606A	-5.0000	0.4867	2.0000	
----	VAR H6C601	0.5000	0.9672	3.0000	
----	VAR H7C601	0.5000	1.0062	1.5000	
----	VAR H7C603		0.5113	1.5000	
----	VAR H7C606A		0.5519	1.0000	
----	VAR HAC02		9.6649	10000.0000	
----	VAR HAC05	10.0000	354.6816	10000.0000	
----	VAR HAC07	10.0000	364.3465	10000.0000	
----	VAR HAC09	10.0000	1366.4582	10000.0000	
----	VAR HAC12		8.1937	10000.0000	
----	VAR HAC15	10.0000	374.6660	10000.0000	
----	VAR HAC18	10.0000	382.8597	10000.0000	
----	VAR HAC20	10.0000	1076.1438	10000.0000	
----	VAR HAC23		7.0620	10000.0000	
----	VAR HAC26	10.0000	717.1264	10000.0000	
----	VAR HAC29	10.0000	724.1884	10000.0000	
----	VAR HAC31	10.0000	1509.4617	10000.0000	
----	VAR HAC34		6.2820	10000.0000	
----	VAR HAC37	10.0000	538.9715	10000.0000	
----	VAR HAC40	10.0000	545.2535	10000.0000	
----	VAR HAC42	10.0000	1456.4752	10000.0000	
----	VAR HACAC09	10.0000	445.9795	10000.0000	
----	VAR HACAC20	10.0000	399.8959	10000.0000	
----	VAR HACAC31	10.0000	733.2773	10000.0000	
----	VAR HACAC42	10.0000	685.6993	10000.0000	
----	VAR HC301	10.0000	3259.6087	10000.0000	
----	VAR HC302		324.8391	5000.0000	
----	VAR HC303	0.0001	3584.4478	10000.0000	
----	VAR HC306	0.0001	4675.3384	10000.0000	
----	VAR HC307	0.0001	3128.1527	10000.0000	
----	VAR HC308	0.0001	1998.4013	10000.0000	
----	VAR HC309	0.0001	1954.0900	10000.0000	
----	VAR HC310	0.0001	693.6764	5000.0000	
----	VAR HC311	0.0010	1260.4136	10000.0000	

\_Economic Optimization Program

05/15/01 16:49:39 PAGE 155  
GAMS 2.50A Windows NT/95/98

	LOWER	LEVEL	UPPER	MARGINAL
----	VAR HC312	0.0001	1640.5462	10000.0000
----	VAR HC312LIQ		1129.7514	10000.0000
----	VAR HC315	0.0001	1034.0568	10000.0000
----	VAR HC316	0.0001	1210.7225	10000.0000
----	VAR HC317	0.0001	1238.7144	10000.0000
----	VAR HC318	0.0001	1062.0487	10000.0000
----	VAR HC319	0.0001	969.4326	10000.0000
----	VAR HC321		47.4076	5000.0000
----	VAR HC322	0.0001	895.8203	5000.0000
----	VAR HC323		584.7248	10000.0000
----	VAR HC324	0.0001	775.1915	10000.0000
----	VAR HC325	0.0001	773.4379	10000.0000
----	VAR HC326	0.0001	538.1101	5000.0000
----	VAR HC329	0.0001	502.2361	5000.0000
----	VAR HC401		1222.9616	5000.0000
----	VAR HC402	10.0000	1230.0497	10000.0000
----	VAR HC403	0.0001	1294.6622	10000.0000
----	VAR HC404	0.0001	1347.0794	10000.0000
----	VAR HC405	0.0001	751.3369	5000.0000
----	VAR HC406	0.0001	698.9197	5000.0000
----	VAR HC407	0.0001	509.0253	5000.0000
----	VAR HC408	0.0001	2553.6794	10000.0000
----	VAR HC408VAP	10.0000	3329.0390	10000.0000
----	VAR HC409	0.0001	3521.0390	10000.0000
----	VAR HC410	0.0001	608.7064	10000.0000
----	VAR HC410VAP	10.0000	853.7388	10000.0000
----	VAR HC411	10.0000	894.4285	10000.0000
----	VAR HC412	0.0001	41.9762	5000.0000
----	VAR HC412LIQ	1.0000	30.3886	1000.0000
----	VAR HC413	0.0001	23.5844	5000.0000
----	VAR HC414	0.0001	2833.5880	10000.0000
----	VAR HC414LIQ	10.0000	1994.4218	10000.0000
----	VAR HC415	0.0001	1761.4453	5000.0000
----	VAR HC417	0.0001	82.0847	5000.0000
----	VAR HC418	0.0001	1843.5300	10000.0000
----	VAR HC419	0.0001	1823.0505	10000.0000
----	VAR HC425	10.0000	2767.4661	10000.0000
----	VAR HC426	10.0000	2158.7597	5000.0000
----	VAR HC427		3010.0998	10000.0000
----	VAR HC428	10.0000	2115.6713	10000.0000
----	VAR HC430	10.0000	2735.3920	10000.0000
----	VAR HC431	10.0000	2975.4635	10000.0000
----	VAR HC432	10.0000	2933.4873	10000.0000
----	VAR HC623	10.0000	86.7552	5000.0000

\_Economic Optimization Program

05/15/01 16:49:39 PAGE 156  
GAMS 2.50A Windows NT/95/98

	LOWER	LEVEL	UPPER	MARGINAL
---- VAR HC625	10.0000	10.0000	5000.0000	-0.0003
---- VAR HC627	10.0000	10.0000	5000.0000	-0.0006
---- VAR HC629	10.0000	140.9275	5000.0000	.
---- VAR HHC01	.	470.9653	5000.0000	.
---- VAR HHC02	.	463.8772	5000.0000	.
---- VAR HHC03	1.0000	1870.4581	10000.0000	.
---- VAR HHC04	10.0000	1805.8456	10000.0000	.
---- VAR HHC05	10.0000	1744.7563	10000.0000	.
---- VAR HHC06	10.0000	2208.6335	10000.0000	.
---- VAR HHC07	10.0000	600.2049	5000.0000	.
---- VAR HHC11	10.0000	536.1429	5000.0000	.
---- VAR HHC14	10.0000	536.1429	5000.0000	.
---- VAR HHC16	10.0000	536.1429	5000.0000	.
---- VAR HHC29	20.0000	845.1483	10000.0000	.
---- VAR HHC30	20.0000	906.2376	10000.0000	.
---- VAR HHC31	100.0000	4482.5703	10000.0000	.
---- VAR HHC32	.	935.5745	5000.0000	.
---- VAR HHC34	.	315.1517	5000.0000	.
---- VAR HHC38	.	147.1412	5000.0000	.
---- VAR HHC41	.	239.1304	5000.0000	.
---- VAR HHC45	.	234.1512	5000.0000	.
---- VAR HLHC29	.	328.5750	10000.0000	.
---- VAR HLHC30	.	239.1871	10000.0000	.
---- VAR HLHC31	20.0000	1222.9616	10000.0000	.
---- VAR HLR1	.	1294.1055	10000.0000	.
---- VAR HLR29	10.0000	969.8760	10000.0000	.
---- VAR HR1	.	3328.6500	10000.0000	.
---- VAR HR29	20.0000	3576.3327	10000.0000	.
---- VAR HSC401	10.0000	279.8453	10000.0000	.
---- VAR HSC402	10.0000	284.0376	10000.0000	.
---- VAR HSC403	10.0000	204.7536	10000.0000	.
---- VAR HSC404	10.0000	200.5613	10000.0000	.
---- VAR HSC405	10.0000	175.9339	10000.0000	.
---- VAR HSC406	0.1000	956.5194	10000.0000	.
---- VAR HSC407	10.0000	1410.8739	10000.0000	.
---- VAR HSC408	10.0000	1354.1002	10000.0000	.
---- VAR HSC409	10.0000	908.0290	5000.0000	.
---- VAR HSC411	10.0000	819.1895	5000.0000	.
---- VAR HSC412	10.0000	88.8395	10000.0000	.
---- VAR HSC413	10.0000	82.0611	10000.0000	.
---- VAR HSC414	.	0.0236	500.0000	.
---- VAR HVHC29	10.0000	516.5734	10000.0000	.
---- VAR HVHC30	10.0000	667.0506	10000.0000	.
---- VAR HVHC31	20.0000	3259.6087	10000.0000	.

\_Economic Optimization Program

05/15/01 16:49:39 PAGE 157  
GAMS 2.50A Windows NT/95/98

	LOWER	LEVEL	UPPER	MARGINAL
---- VAR HVR1	.	2034.5445	10000.0000	.
---- VAR HVR29	10.0000	2606.4566	10000.0000	.
---- VAR K1C323	1.0000	2.0354	3.0000	.
---- VAR K1C325	0.5000	1.0000	2.0000	.
---- VAR K1C408	1.0000	7.9557	15.0000	.
---- VAR K1C414	1.0000	2.5362	4.0000	.
---- VAR K1C428	.	4.2370	10.0000	.
---- VAR K1C430	1.0000	3.7549	6.0000	.
---- VAR K1C601	1.5000	2.6034	3.0000	.
---- VAR K1C603	1.0000	1.2665	3.0000	.
---- VAR K1C606A	1.0000	1.8218	3.0000	.
---- VAR K1C606C	1.0000	4.1667	7.0000	.
---- VAR K1C614B	2.0000	3.2880	3.5000	.
---- VAR K1C615_A	0.5000	2.3914	4.0000	.
---- VAR K1C616_A	0.5000	2.8252	5.0000	.
---- VAR K1E633	1.0000	4.0740	5.5000	.
---- VAR K1E6XX	1.0000	4.0370	5.5000	.
---- VAR K1SC406	2.0000	3.6174	5.0000	.
---- VAR K1SC408	1.5000	2.4874	3.5000	.
---- VAR K2C601	0.5000	0.7617	1.0000	.
---- VAR K2E633	0.2000	1.1530	1.5000	.
---- VAR K2E6XX	0.2000	1.1425	1.5000	.
---- VAR K2SC406	0.5000	1.1373	1.2000	.
---- VAR K2SC408	0.5000	0.7204	1.0000	.
---- VAR K3C323	0.5000	0.8944	1.5000	.
---- VAR K3C325	0.0100	0.4011	1.5000	.
---- VAR K3C408	1.0000	3.8360	6.0000	.
---- VAR K3C414	0.5000	1.0578	3.0000	.
---- VAR K3C428	.	1.8859	5.0000	.
---- VAR K3C430	1.0000	1.6462	5.0000	.
---- VAR K3C601	0.5000	1.0389	2.0000	.
---- VAR K3C603	0.5000	0.5239	1.0000	.
---- VAR K3C606A	0.5000	0.7277	3.0000	.
---- VAR K3C606C	1.0000	1.8481	5.0000	.
---- VAR K3C614B	0.6000	1.0405	1.5000	.
---- VAR K3C615_A	0.1000	0.9748	2.0000	.
---- VAR K3C616_A	0.1000	1.0094	2.0000	.
---- VAR K3E633	0.3000	1.3727	2.0000	.

----	VAR K3E6XX	0.3000	1.3602	3.0000	.
----	VAR K3SC406	1.0000	1.5069	2.0000	.
----	VAR K3SC408	0.7000	0.9866	1.5000	.
----	VAR K4C323	0.5000	0.6793	1.0000	.
----	VAR K4C325	0.0300	0.2894	1.0000	.
----	VAR K4C408	1.0000	3.0229	5.0000	.

	LOWER	LEVEL	UPPER	MARGINAL	
----	VAR K4C414	0.5000	0.7808	2.0000	.
----	VAR K4C428	.	1.4416	5.0000	.
----	VAR K4C430	0.5000	1.2488	3.0000	.
----	VAR K4C601	0.2000	0.7472	1.0000	.
----	VAR K4C603	0.1000	0.3849	1.0000	.
----	VAR K4C606A	0.1000	0.5237	3.0000	.
----	VAR K4C606C	1.0000	1.4103	4.0000	.
----	VAR K4C614B	0.5000	0.6541	1.0000	.
----	VAR K4C615_A	0.0500	0.7037	1.5000	.
----	VAR K4C616_A	0.0500	0.6776	1.5000	.
----	VAR K4E633	0.2000	0.9005	1.5000	.
----	VAR K4E6XX	0.2000	0.8923	1.5000	.
----	VAR K4SC406	0.8000	1.1115	1.5000	.
----	VAR K4SC408	0.5000	0.7071	1.0000	.
----	VAR K5C323	0.1000	0.3108	0.6000	.
----	VAR K5C325	0.1000	0.1194	0.6000	.
----	VAR K5C408	0.5000	1.5088	3.0000	.
----	VAR K5C414	0.1000	0.3372	2.0000	.
----	VAR K5C428	.	0.6686	2.0000	.
----	VAR K5C430	0.2000	0.5700	1.5000	.
----	VAR K5C601	0.1000	0.3065	0.5000	.
----	VAR K5C603	0.0100	0.1647	0.5000	.
----	VAR K5C606A	0.1000	0.2151	1.0000	.
----	VAR K5C606C	0.1000	0.6517	1.2000	.
----	VAR K5C614B	0.0500	0.1859	0.8000	.
----	VAR K5C615_A	0.0020	0.2696	1.0000	.
----	VAR K5C616_A	0.0020	0.2215	1.0000	.
----	VAR K5E633	0.0500	0.3075	1.0000	.
----	VAR K5E6XX	0.0500	0.3047	1.0000	.
----	VAR K5SC406	0.1000	0.4794	0.6000	.
----	VAR K5SC408	0.2000	0.2880	0.6000	.
----	VAR K6C601	0.1000	0.2384	1.0000	.
----	VAR K6SC406	.	0.3815	0.5000	.
----	VAR K6SC408	0.1000	0.2233	0.5000	.
----	VAR K7C323	0.1000	0.1213	0.3000	.
----	VAR K7C325	0.0010	0.0399	0.2000	.
----	VAR K7C408	0.1000	0.6737	1.0000	.
----	VAR K7C414	0.0500	0.1205	1.0000	.
----	VAR K7C428	.	0.2663	2.0000	.
----	VAR K7C430	.	0.2216	1.0000	.
----	VAR K7C601	0.0100	0.1015	0.5000	.
----	VAR K7C603	0.0100	0.0580	0.5000	.
----	VAR K7C606A	0.0500	0.0713	0.5000	.
----	VAR K7C614B	0.0010	0.0456	0.1000	.

	LOWER	LEVEL	UPPER	MARGINAL	
----	VAR K7C615_A	0.0010	0.1025	1.0000	.
----	VAR K7C616_A	0.0110	0.0668	1.0000	.
----	VAR K7E633	0.0100	0.0747	0.1000	.
----	VAR K7E6XX	0.0100	0.0740	0.1000	.
----	VAR K7SC406	0.1000	0.1710	0.3000	.
----	VAR K7SC408	0.0500	0.0943	0.2000	.
----	VAR KP1C601	1.0000	3.1476	5.0000	.
----	VAR KP1C603	1.0000	1.7975	3.0000	.
----	VAR KP1C606A	1.0000	2.2725	5.0000	.
----	VAR KP1C606D	1.0000	6.1168	12.0000	.
----	VAR KP2C601	0.5000	0.9604	1.5000	.
----	VAR KP3C601	1.0000	1.2878	2.0000	.
----	VAR KP3C603	0.5000	0.7776	1.5000	.
----	VAR KP3C606A	0.5000	0.9345	3.0000	.
----	VAR KP3C606D	1.0000	2.8514	5.0000	.
----	VAR KP4C601	0.5000	0.9400	1.5000	.
----	VAR KP4C603	0.2000	0.5858	1.0000	.
----	VAR KP4C606A	0.1000	0.6841	3.0000	.
----	VAR KP4C606D	1.0000	2.2235	5.0000	.
----	VAR KP5C601	0.1000	0.3971	1.0000	.
----	VAR KP5C603	0.1000	0.2635	0.5000	.
----	VAR KP5C606A	0.1000	0.2907	1.0000	.
----	VAR KP5C606D	1.0000	1.0786	5.0000	.
----	VAR KP6C601	0.1000	0.3131	1.0000	.
----	VAR KP7C601	0.0100	0.1373	1.0000	.
----	VAR KP7C603	0.0100	0.1002	0.3000	.
----	VAR KP7C606A	0.0500	0.1014	0.5000	.
----	VAR KP7C606D	0.1000	0.4605	5.0000	.
----	VAR KWAD1	50.0000	171.1066	300.0000	.
----	VAR KWAD2	105.0000	288.8934	355.0000	.

----	VAR LPC601	1.0000	1.7854	5.0000	.
----	VAR LPC603	1.0000	2.4984	10.0000	.
----	VAR LPC606A	0.5000	2.7522	5.0000	.
----	VAR PC303	101.0000	101.0000	140.0000	-0.0032
----	VAR PC306	650.0000	870.0000	900.0000	.
----	VAR PC307	600.0000	800.0000	850.0000	.
----	VAR PC308	600.0000	800.0000	800.0000	0.0006
----	VAR PC309	580.0000	780.0000	780.0000	.
----	VAR PC311	260.0000	260.0000	400.0000	-0.0001
----	VAR PC312	600.0000	800.0000	850.0000	.
----	VAR PHC30	101.0000	132.0436	140.0000	EPS
----	VAR PHC32	101.0000	101.0000	200.0000	.
----	VAR PR29	101.0000	133.2555	140.0000	.
----	VAR PROFIT	10.0000	29.1128	10000.0000	.

05/15/01 16:49:39 PAGE 160  
GAMS 2.50A Windows NT/95/98

	LOWER	LEVEL	UPPER	MARGINAL
----	VAR Q2HC07	0.0387	1.0000	.
----	VAR Q2HC11	0.0346	1.0000	.
----	VAR Q2HC14	0.0346	1.0000	.
----	VAR Q2HC16	0.0346	1.0000	.
----	VAR QFP1C606A	0.0243	1.0000	.
----	VAR QFP3C606A	0.0024	0.1000	.
----	VAR QFP4C606A	0.8557	1.0000	.
----	VAR QFP5C606A	0.6016	1.0000	.
----	VAR QFP7C606A	0.2539	1.0000	.
----	VAR QS1C606A	0.7801	1.0000	.
----	VAR QS3C606A	0.5164	1.0000	.
----	VAR QS4C606A	0.0502	0.5000	.
----	VAR QS5C606A	0.0276	0.5500	.
----	VAR QS7C606A	0.0052	0.1600	.
----	VAR R10C623	.	0.1000	.
----	VAR R10C625	.	0.1000	.
----	VAR R10C627	1.4078353E-6	0.1000	.
----	VAR R10C629	1.1954751E-6	0.1000	.
----	VAR R2C623	0.0097	0.8320	.
----	VAR R2C625	0.0087	0.8320	.
----	VAR R2C627	0.0087	0.8320	.
----	VAR R2C629	0.0087	0.8320	.
----	VAR R3C623	0.0112	0.1500	.
----	VAR R3C625	0.0102	0.1500	.
----	VAR R3C627	0.0102	0.1500	.
----	VAR R3C629	0.0102	0.1500	.
----	VAR R4C623	0.0015	0.0300	.
----	VAR R4C625	0.0015	0.0300	.
----	VAR R4C627	0.0015	0.0300	.
----	VAR R4C629	0.0014	0.0300	.
----	VAR R5C623	8.5081000E-6	0.3000	.
----	VAR R5C625	1.2019948E-5	0.3000	.
----	VAR R5C627	2.0557128E-5	0.3000	.
----	VAR R5C629	1.7021917E-5	0.3000	.
----	VAR R7C623	.	0.0500	.
----	VAR R7C625	.	0.0500	.
----	VAR R7C627	.	0.0500	.
----	VAR R7C629	.	0.0500	.
----	VAR R8C623	8.9334292E-6	0.1000	.
----	VAR R8C625	1.2406103E-5	0.1000	.
----	VAR R8C627	2.0681053E-5	0.1000	.
----	VAR R8C629	1.7308833E-5	0.1000	.
----	VAR R9C623	0.0097	0.1000	.
----	VAR R9C625	0.0087	0.1000	.

05/15/01 16:49:39 PAGE 161  
GAMS 2.50A Windows NT/95/98

	LOWER	LEVEL	UPPER	MARGINAL	
----	VAR R9C627	0.0087	0.1000	.	
----	VAR R9C629	0.0087	0.1000	.	
----	VAR RHO2HC07	610.0000	650.0000	650.0000	0.0317
----	VAR RHO2HC11	610.0000	650.0000	650.0000	0.0284
----	VAR RHO2HC14	610.0000	650.0000	650.0000	0.0285
----	VAR RHO2HC16	610.0000	650.0000	650.0000	0.0287
----	VAR RHOAC09	1500.0000	1700.0000	1700.0000	0.0002
----	VAR RHOAC20	1500.0000	1700.0000	1700.0000	0.0002
----	VAR RHOAC31	1500.0000	1700.0000	1700.0000	0.0002
----	VAR RHOAC42	1500.0000	1700.0000	1700.0000	0.0002
----	VAR RIC10C623	.	0.3000	.	
----	VAR RIC10C625	.	0.3000	.	
----	VAR RIC10C627	.	0.3000	.	
----	VAR RIC10C629	.	0.3000	.	
----	VAR RIC11C623	.	0.1000	.	
----	VAR RIC11C625	.	0.1000	.	
----	VAR RIC11C627	1.1922910E-6	0.1000	.	
----	VAR RIC11C629	.	0.1000	.	
----	VAR SF1S34	0.0001	0.0270	1.0000	.
----	VAR SF2S34	.	0.0489	1.0000	.
----	VAR SFS11	0.1000	0.5000	0.8000	.
----	VAR SFS19	0.1000	0.4941	0.8000	.

----	VAR SFS2	0.1000	0.7975	1.0000	.
----	VAR SFS23	0.1000	0.6817	0.8000	.
----	VAR SFS27	0.1000	0.5053	0.8000	.
----	VAR SFS41	0.0001	0.9859	1.0000	.
----	VAR SFS42	0.0001	0.7800	1.0000	.
----	VAR SFS5	0.1000	0.2718	0.5000	.
----	VAR SFS7	0.1000	0.3333	0.8000	.
----	VAR SM1C601	1.0000	2.5926	5.0000	.
----	VAR SM1C603	0.0500	0.5764	1.0000	.
----	VAR SM1C606A	0.1000	2.4236	5.0000	.
----	VAR SM1C606D	1.0000	2.9391	5.0000	.
----	VAR SM2C601	0.5000	0.7910	1.0000	.
----	VAR SM3C601	0.5000	1.0607	2.0000	.
----	VAR SM3C603	0.0010	0.2493	0.5000	.
----	VAR SM3C606A	0.1000	0.9966	5.0000	.
----	VAR SM3C606D	1.0000	1.3082	10.0000	.
----	VAR SM4C601	0.4000	0.7743	1.5000	.
----	VAR SM4C603	0.0100	0.1878	0.5000	.
----	VAR SM4C606A	0.1000	0.7296	5.0000	.
----	VAR SM4C606D	0.5000	1.0000	5.0000	.
----	VAR SM5C601	0.1000	0.3270	0.6000	.
----	VAR SM5C603	0.0100	0.0845	0.5000	.

\_\_Economic Optimization Program

05/15/01 16:49:39 PAGE 162  
GAMS 2.50A Windows NT/95/98

	LOWER	LEVEL	UPPER	MARGINAL	
----	VAR SM5C606A	0.0500	0.3100	5.0000	.
----	VAR SM5C606D	0.1000	0.4638	5.0000	.
----	VAR SM6C601	0.1000	0.2579	1.0000	.
----	VAR SM7C601	0.0100	0.1131	0.2000	.
----	VAR SM7C603	0.0010	0.0321	0.2000	.
----	VAR SM7C606A	0.0010	0.1081	5.0000	.
----	VAR SM7C606D	0.1000	0.1847	5.0000	.
----	VAR SN1C601	1.0000	2.8857	5.0000	.
----	VAR SN1C603	1.0000	1.3570	3.0000	.
----	VAR SN1C606A	1.0000	3.4785	20.0000	.
----	VAR SN2C601	0.5000	0.8443	1.5000	.
----	VAR SN3C601	0.5000	1.1515	1.5000	.
----	VAR SN3C603	0.5000	0.5613	1.5000	.
----	VAR SN3C606A	1.0000	1.3895	15.0000	.
----	VAR SN4C601	0.5000	0.8282	1.0000	.
----	VAR SN4C603	0.2000	0.4124	1.0000	.
----	VAR SN4C606A	0.8000	1.0000	10.0000	.
----	VAR SN5C601	0.1000	0.3398	0.8000	.
----	VAR SN5C603	0.1000	0.1764	0.4000	.
----	VAR SN5C606A	0.3000	0.4107	10.0000	.
----	VAR SN6C601	0.1000	0.2643	1.0000	.
----	VAR SN7C601	0.0100	0.1125	0.5000	.
----	VAR SN7C603	0.0100	0.0622	0.5000	.
----	VAR SN7C606A	0.1000	0.1362	5.0000	.
----	VAR TAC02	276.0000	276.0000	290.0000	-2.925791E-5
----	VAR TAC05	273.0000	280.0000	300.0000	.
----	VAR TAC07	273.0000	280.0006	300.0000	.
----	VAR TAC15	273.0000	280.0000	300.0000	.
----	VAR TAC18	273.0000	280.0611	300.0000	.
----	VAR TAC20	280.0000	280.0000	300.0000	-0.0019
----	VAR TAC26	273.0000	280.0000	300.0000	.
----	VAR TAC29	273.0000	280.1146	300.0000	.
----	VAR TAC37	273.0000	280.0000	300.0000	.
----	VAR TAC40	273.0000	280.0363	300.0000	.
----	VAR TC301	200.0000	282.6006	300.0000	.
----	VAR TC302	250.0000	261.9077	290.0000	.
----	VAR TC309	270.0000	322.9752	350.0000	.
----	VAR TC310	200.0000	288.1849	310.0000	.
----	VAR TC311	270.0000	288.1849	310.0000	.
----	VAR TC312	300.0000	328.4033	369.0000	.
----	VAR TC318	250.0000	321.5069	365.0000	.
----	VAR TC319	250.0000	300.0000	400.0000	.
----	VAR TC320	250.0000	300.0000	400.0000	.
----	VAR TC322	250.0000	300.0000	400.0000	.

\_\_Economic Optimization Program

05/15/01 16:49:39 PAGE 163  
GAMS 2.50A Windows NT/95/98

	LOWER	LEVEL	UPPER	MARGINAL	
----	VAR TC323	300.0000	359.0690	420.0000	.
----	VAR TC326	300.0000	322.5997	360.0000	.
----	VAR TC328	300.0000	322.5997	360.0000	.
----	VAR TC329	300.0000	322.5997	375.0000	.
----	VAR TC401	260.0000	282.6006	300.0000	.
----	VAR TC402	270.0000	283.9220	305.0000	.
----	VAR TC403	280.0000	295.8124	320.0000	.
----	VAR TC406	298.0000	389.0844	400.0000	.
----	VAR TC409	400.0000	460.9878	461.0000	.
----	VAR TC411	300.0000	403.7525	418.0000	.
----	VAR TC412	330.0000	363.3260	405.0000	.
----	VAR TC413	250.0000	301.0000	350.0000	.
----	VAR TC415	250.0000	307.2720	400.0000	.
----	VAR TC417	275.0000	299.9913	350.0000	.

----	VAR TC425	300.0000	363.3260	410.0000	.
----	VAR TC426	300.0000	363.3260	410.0000	.
----	VAR TC427	360.0000	375.0766	405.0000	.
----	VAR TC428	300.0000	364.9471	405.0000	.
----	VAR TC430	300.0000	358.0220	400.0000	.
----	VAR TC431	300.0000	363.3260	405.0000	.
----	VAR TC432	350.0000	363.3260	400.0000	.
----	VAR TCWOTE609A	298.0000	308.1986	320.0000	.
----	VAR TCWOTE621A	298.0000	326.6519	355.0000	.
----	VAR TCWOTE621B	298.0000	298.0000	325.0000	-0.0063
----	VAR TCWOTE627A	295.0000	295.0000	360.0000	EPS
----	VAR TCWOTE627B	293.0000	293.0000	310.0000	-0.6540
----	VAR TCWOTE641A	295.0000	318.4033	360.0000	.
----	VAR TCWOTE641B	295.0000	312.9752	325.0000	.
----	VAR TCWOUTE603	296.8360	321.4823	350.0000	.
----	VAR TCWOUTE605	298.0000	305.6485	320.0000	.
----	VAR TCWOUTE611	295.0000	297.3066	350.0000	.
----	VAR TCWOUTE613	298.0000	312.5997	320.0000	.
----	VAR TCWOUTE617	295.0000	319.1717	350.0000	.
----	VAR TCWOUTE626	295.0000	295.0000	310.0000	-0.0030
----	VAR TCWOUTE634	295.0000	340.9683	360.0000	.
----	VAR TCWOUTE640	295.0000	316.3947	330.0000	.
----	VAR THC01	295.0000	296.2800	370.0000	.
----	VAR THC02	275.0000	292.6006	302.0000	.
----	VAR THC03	290.0000	304.2455	360.0000	.
----	VAR THC04	280.0000	296.0857	310.0000	.
----	VAR THC05	270.0000	288.2197	300.0000	.
----	VAR THC06	273.0000	289.0923	300.0000	.
----	VAR THC07	273.0000	289.0923	300.0000	.
----	VAR THC11	273.0000	289.0923	300.0000	.

\_Economic Optimization Program

05/15/01 16:49:39 PAGE 164  
GAMS 2.50A Windows NT/95/98

	LOWER	LEVEL	UPPER	MARGINAL	
----	VAR THC14	273.0000	289.0923	300.0000	.
----	VAR THC16	273.0000	289.0923	300.0000	.
----	VAR THC22	273.0000	280.0000	290.0000	.
----	VAR THC23	273.0000	280.0000	290.0000	.
----	VAR THC24	273.0000	280.0000	290.0000	.
----	VAR THC25	273.0000	280.0000	290.0000	.
----	VAR THC26	273.0000	280.0000	290.0000	.
----	VAR THC27	273.0000	280.0000	290.0000	.
----	VAR THC28	270.0000	280.0000	290.0000	.
----	VAR THC29	270.0000	280.0000	290.0000	.
----	VAR THC30	250.0000	280.0000	300.0000	.
----	VAR THC31	260.0000	282.6006	310.0000	.
----	VAR THC34	250.0000	261.9077	310.0000	.
----	VAR THC38	250.0000	261.9077	310.0000	.
----	VAR THC41	250.0000	261.9077	310.0000	.
----	VAR THC45	250.0000	261.9077	310.0000	.
----	VAR TMC601	315.0000	329.7466	360.0000	.
----	VAR TMC603	350.0000	352.1470	375.0000	.
----	VAR TMC606A	327.0000	331.6356	370.0000	.
----	VAR TMC606D	370.0000	387.4735	400.0000	.
----	VAR TMK601	273.0000	307.0119	333.0000	.
----	VAR TNC601	310.0000	320.8163	340.0000	.
----	VAR TNC603	320.0000	333.9124	375.0000	.
----	VAR TNC606A	310.0000	321.1676	370.0000	.
----	VAR TR1	270.0000	280.0000	290.0000	.
----	VAR TR29	260.0000	280.0000	300.0000	.
----	VAR TSC401	280.0000	319.2902	350.0000	.
----	VAR TSC404	310.0000	331.4823	365.0000	.
----	VAR TSC406	320.0000	336.6046	360.0000	.
----	VAR TSC407	320.0000	336.6046	400.0000	.
----	VAR TSC409	308.0000	318.7440	360.0000	.
----	VAR TSC411	308.0000	318.7440	375.0000	.
----	VAR TSC412	308.0000	318.7440	360.0000	.
----	VAR TSC414	275.0000	275.0000	320.0000	-3.485868E-7
----	VAR UTILITIES	-10000.0000	8.2029	10000.0000	.
----	VAR VFC614B	0.1000	0.1628	0.8000	.
----	VAR VFC615	0.0010	0.3596	0.6000	.
----	VAR VFC616	0.0500	0.2507	1.0000	.
----	VAR VFM3	.	0.4793	0.5500	.
----	VAR VPC601	1.0000	1.4706	5.0000	.
----	VAR VPC603	0.0100	0.8012	3.0000	.
----	VAR VPC606A	0.1000	2.9352	10.0000	.
----	VAR X10AC09	.	.	0.1000	.
----	VAR X10AC20	.	.	0.1000	.

\_Economic Optimization Program

05/15/01 16:49:39 PAGE 165  
GAMS 2.50A Windows NT/95/98

	LOWER	LEVEL	UPPER	MARGINAL	
----	VAR X10AC31	.	.	0.1000	.
----	VAR X10AC42	.	.	0.1000	.
----	VAR X11AC02	0.9700	0.9980	0.9980	702.6718
----	VAR X11AC05	0.8900	0.9687	0.9990	.
----	VAR X11AC07	0.8900	0.9693	0.9990	.
----	VAR X11AC09	.	0.7743	1.0000	.

----	VAR X11AC15	0.8900	0.9424	0.9990	.
----	VAR X11AC18	0.8900	0.9429	0.9990	.
----	VAR X11AC20	.	0.8186	1.0000	.
----	VAR X11AC26	0.8900	0.9162	0.9990	.
----	VAR X11AC29	0.8900	0.9164	0.9990	.
----	VAR X11AC31	.	0.8472	1.0000	.
----	VAR X11AC37	0.8900	0.8900	0.9990	-708.3909
----	VAR X11AC40	0.8900	0.8903	0.9990	.
----	VAR X11AC42	.	0.8091	1.0000	.
----	VAR X12AC02	0.0020	0.0020	0.0300	.
----	VAR X12AC05	0.0010	0.0313	0.1100	.
----	VAR X12AC07	0.0010	0.0307	0.1100	.
----	VAR X12AC09	.	0.0251	0.1000	.
----	VAR X12AC12	0.0010	0.0313	0.1200	.
----	VAR X12AC15	0.0010	0.0576	0.1100	.
----	VAR X12AC18	0.0010	0.0571	0.1100	.
----	VAR X12AC20	.	0.0500	0.1000	.
----	VAR X12AC23	0.0010	0.0576	0.1200	.
----	VAR X12AC26	0.0010	0.0838	0.1100	.
----	VAR X12AC29	0.0010	0.0836	0.1100	.
----	VAR X12AC31	.	0.0775	0.1000	.
----	VAR X12AC34	0.0010	0.0838	0.1200	.
----	VAR X12AC37	0.0010	0.1100	0.1100	.
----	VAR X12AC40	0.0010	0.1097	0.1100	.
----	VAR X12AC42	.	0.1000	0.1000	4.6738
----	VAR X12AC45	0.0010	0.1100	0.1200	.
----	VAR X1AC09	.	0.0090	0.1000	.
----	VAR X1AC20	.	0.0065	0.1000	.
----	VAR X1AC31	.	0.0035	0.1000	.
----	VAR X1AC42	.	0.0042	0.1000	.
----	VAR X1C301	.	0.0671	0.2000	.
----	VAR X1C302	.	0.0780	0.2000	.
----	VAR X1C303	0.0500	0.0681	0.2200	.
----	VAR X1C306	.	0.0721	0.5000	.
----	VAR X1C307	.	0.0721	0.5000	.
----	VAR X1C308	.	0.0472	0.4000	.
----	VAR X1C309	.	0.0472	0.5000	.
----	VAR X1C310	.	0.0931	0.5000	.

\_Economic Optimization Program

	LOWER	LEVEL	UPPER	MARGINAL	
----	VAR X1C311	.	0.0318	0.2000	.
----	VAR X1C312	.	0.1166	1.0000	.
----	VAR X1C315	0.0001	0.1166	1.0000	.
----	VAR X1C317	.	0.0882	0.3000	.
----	VAR X1C318	0.0001	0.0882	0.3000	.
----	VAR X1C319	0.0001	0.0882	0.1000	.
----	VAR X1C320	.	0.0882	0.1000	.
----	VAR X1C321	0.0001	0.0882	0.1000	.
----	VAR X1C322	.	0.0882	0.1500	.
----	VAR X1C323	.	0.0882	0.2000	.
----	VAR X1C324	.	0.0882	0.3000	.
----	VAR X1C326	0.4000	1.0000	1.0000	.
----	VAR X1C328	0.4000	1.0000	1.0000	.
----	VAR X1C329	0.4000	1.0000	1.0000	.
----	VAR X1C401	.	0.0147	0.2000	.
----	VAR X1C402	.	0.0147	0.2000	.
----	VAR X1C403	.	0.0147	0.2000	.
----	VAR X1C404	.	0.0147	0.2000	.
----	VAR X1C405	.	.	0.0100	.
----	VAR X1C406	.	.	0.0100	.
----	VAR X1C407	.	.	0.0100	.
----	VAR X1C408	.	.	1.0000	.
----	VAR X1C409	.	.	0.0100	.
----	VAR X1C410	0.0001	0.0003	1.0000	.
----	VAR X1C411	.	0.0003	0.1000	.
----	VAR X1C412	.	0.0015	0.0500	.
----	VAR X1C413	.	0.0015	0.1000	.
----	VAR X1C414	.	0.0586	0.2500	.
----	VAR X1C415	.	0.0586	0.2000	.
----	VAR X1C418	.	0.0569	0.3000	.
----	VAR X1C419	0.0001	0.0569	0.2000	.
----	VAR X1C425	.	0.0003	0.1000	.
----	VAR X1C426	.	0.0003	0.1000	.
----	VAR X1C427	.	0.0004	1.0000	.
----	VAR X1C428	.	0.0005	0.1000	.
----	VAR X1C430	.	0.0005	0.1000	.
----	VAR X1C431	.	0.0015	0.1000	.
----	VAR X1C432	.	0.0015	0.1000	.
----	VAR X1HC01	0.0010	0.0592	0.3000	.
----	VAR X1HC02	.	0.0592	0.3000	.
----	VAR X1HC03	0.0001	0.0577	0.2000	.
----	VAR X1HC04	.	0.0577	0.2000	.
----	VAR X1HC05	.	0.0577	0.2000	.
----	VAR X1HC06	.	0.0580	0.2000	.

\_Economic Optimization Program

	LOWER	LEVEL	UPPER	MARGINAL
---- VAR X1HC07	.	0.0580	0.2000	.
---- VAR X1HC08	.	0.0580	0.2000	.
---- VAR X1HC11	.	0.0580	0.2000	.
---- VAR X1HC14	.	0.0580	0.2000	.
---- VAR X1HC15	.	0.0580	0.2000	.
---- VAR X1HC16	.	0.0580	0.2000	.
---- VAR X1HC22	.	0.0464	0.5000	.
---- VAR X1HC23	.	0.0463	0.5000	.
---- VAR X1HC24	.	0.0464	0.5000	.
---- VAR X1HC25	.	0.0497	0.5000	.
---- VAR X1HC26	.	0.0474	0.5000	.
---- VAR X1HC27	.	0.0450	0.5000	.
---- VAR X1HC28	.	0.0187	0.2000	.
---- VAR X1HC29	.	0.0187	0.2000	.
---- VAR X1HC30	.	0.0144	0.2000	.
---- VAR X1HC31	.	0.0147	0.1000	.
---- VAR X1HC33	.	0.0228	0.1000	.
---- VAR X1HC34	.	0.0228	0.1000	.
---- VAR X1HC38	.	0.0228	0.1000	.
---- VAR X1HC40	.	0.0228	0.1000	.
---- VAR X1HC41	.	0.0228	0.1000	.
---- VAR X1HC45	.	0.0228	0.1000	.
---- VAR X1R1	.	0.0187	0.1000	.
---- VAR X1R29	.	0.0147	0.2000	.
---- VAR X1SC401	.	0.0063	0.1000	.
---- VAR X1SC404	.	.	0.1000	.
---- VAR X1SC405	.	.	0.1000	.
---- VAR X1SC406	.	.	0.1000	.
---- VAR X1SC407	.	.	0.1000	.
---- VAR X1SC409	.	0.0200	0.1000	.
---- VAR X1SC411	.	0.0200	0.1000	.
---- VAR X1SC412	.	0.0200	0.1000	.
---- VAR X1SC413	.	0.0200	0.1000	.
---- VAR X1SC414	.	.	0.1000	.
---- VAR X2AC09	.	.	1.0000	.
---- VAR X2AC20	.	.	1.0000	.
---- VAR X2AC31	.	.	1.0000	.
---- VAR X2AC42	.	.	1.0000	.
---- VAR X2C301	.	.	0.0100	.
---- VAR X2C417	.	3.3333333E-5	0.1000	.
---- VAR X2C418	.	0.0009	0.1000	.
---- VAR X2C419	.	0.0009	0.1000	.
---- VAR X2HC01	0.1000	0.1000	0.7000	.
---- VAR X2HC02	0.1000	0.1000	1.0000	-467.4856

..Economic Optimization Program

05/15/01 16:49:39 PAGE 168  
GAMS 2.50A Windows NT/95/98

	LOWER	LEVEL	UPPER	MARGINAL
---- VAR X2HC03	.	0.0009	0.1000	.
---- VAR X2HC04	.	0.0009	0.1000	.
---- VAR X2HC05	.	0.0009	0.1000	.
---- VAR X2HC06	.	0.0225	0.1500	.
---- VAR X2HC07	.	0.0225	0.1500	.
---- VAR X2HC08	.	0.0225	0.1500	.
---- VAR X2HC11	.	0.0225	0.1500	.
---- VAR X2HC14	.	0.0225	0.1500	.
---- VAR X2HC15	.	0.0225	0.1500	.
---- VAR X2HC16	.	0.0225	0.1500	.
---- VAR X2HC22	.	.	0.1000	.
---- VAR X2HC23	.	.	0.1000	.
---- VAR X2HC24	.	.	0.1000	.
---- VAR X2HC25	.	.	0.1000	.
---- VAR X2HC26	.	.	0.1000	.
---- VAR X2HC27	.	.	0.1000	.
---- VAR X2HC28	.	.	0.1000	.
---- VAR X2HC29	.	.	0.1000	.
---- VAR X2HC30	.	.	0.1000	.
---- VAR X2HC31	.	.	0.1000	EPS
---- VAR X2R1	.	.	0.1000	.
---- VAR X2R29	.	.	0.1000	.
---- VAR X2SC401	.	.	0.1000	.
---- VAR X2SC404	.	.	0.1000	.
---- VAR X2SC405	.	.	0.1000	.
---- VAR X2SC406	.	.	0.1000	.
---- VAR X2SC407	.	.	0.1000	.
---- VAR X2SC409	.	.	0.1000	.
---- VAR X2SC411	.	.	0.1000	.
---- VAR X2SC412	.	.	0.1000	.
---- VAR X2SC413	.	.	0.1000	.
---- VAR X2SC414	.	0.1000	0.1000	0.0240
---- VAR X3AC09	.	0.1350	0.7000	.
---- VAR X3AC20	.	0.0859	0.7000	.
---- VAR X3AC31	.	0.0503	0.7000	.
---- VAR X3AC42	.	0.0606	0.7000	.
---- VAR X3C301	0.5000	0.7721	1.0000	.
---- VAR X3C302	0.4500	0.8214	1.0000	.
---- VAR X3C303	0.5000	0.7767	0.8000	.
---- VAR X3C306	.	0.7813	1.0000	.



```

---- VAR X3C307      .      0.7813      1.0000      .
---- VAR X3C308      .      0.7791      1.0000      .
---- VAR X3C309      0.2000      0.7791      0.8000      .
---- VAR X3C310      .      0.8052      1.0000      .
_Economic Optimization Program

```

05/15/01 16:49:39 PAGE 169  
GAMS 2.50A Windows NT/95/98

	LOWER	LEVEL	UPPER	MARGINAL
---- VAR X3C311	.	0.7703	1.0000	.
---- VAR X3C312	.	0.7851	1.0000	.
---- VAR X3C315	0.0001	0.7851	1.0000	.
---- VAR X3C317	0.5000	0.8104	1.0000	.
---- VAR X3C318	0.0001	0.8104	1.0000	.
---- VAR X3C319	0.0001	0.8104	1.0000	.
---- VAR X3C320	0.0001	0.8104	1.0000	.
---- VAR X3C321	0.0001	0.8104	1.0000	.
---- VAR X3C322	.	0.8104	1.0000	.
---- VAR X3C323	0.5000	0.8104	0.9500	.
---- VAR X3C324	0.5000	0.8104	0.9500	.
---- VAR X3C326	.	1.5978930E-6	0.5000	.
---- VAR X3C328	.	1.5969259E-6	0.5000	.
---- VAR X3C329	.	1.5978930E-6	0.5000	.
---- VAR X3C401	.	0.5001	1.0000	.
---- VAR X3C402	.	0.5001	0.8000	.
---- VAR X3C403	0.0001	0.5001	1.0000	.
---- VAR X3C404	0.0001	0.5001	1.0000	.
---- VAR X3C405	.	1.6916491E-5	0.1000	.
---- VAR X3C406	.	1.6916491E-5	0.0100	.
---- VAR X3C407	.	1.6916491E-5	0.0100	.
---- VAR X3C408	.	1.6916491E-5	1.0000	.
---- VAR X3C409	.	1.6916491E-5	0.0100	.
---- VAR X3C410	0.0001	0.0010	0.1000	.
---- VAR X3C411	0.0001	0.0010	0.2000	.
---- VAR X3C412	.	0.0020	0.1000	.
---- VAR X3C413	.	0.0020	0.1000	.
---- VAR X3C414	0.5000	0.8198	1.0000	.
---- VAR X3C415	.	0.8198	1.0000	.
---- VAR X3C418	0.0001	0.8269	1.0000	.
---- VAR X3C419	0.0001	0.8269	1.0000	.
---- VAR X3C425	.	0.0010	0.1000	.
---- VAR X3C426	0.0001	0.0010	0.1000	.
---- VAR X3C427	.	0.0013	1.0000	.
---- VAR X3C428	.	0.0014	0.3000	.
---- VAR X3C430	.	0.0015	0.1000	.
---- VAR X3C431	.	0.0020	0.1000	.
---- VAR X3C432	.	0.0020	0.1000	.
---- VAR X3HC01	0.0100	0.0100	0.6000	-179.0197
---- VAR X3HC02	.	0.0100	0.5000	.
---- VAR X3HC03	0.1000	0.8264	1.0000	.
---- VAR X3HC04	0.1000	0.8264	1.0000	.
---- VAR X3HC05	0.1000	0.8264	1.0000	.
---- VAR X3HC06	0.3000	0.6485	1.0000	.

05/15/01 16:49:39 PAGE 170  
GAMS 2.50A Windows NT/95/98

	LOWER	LEVEL	UPPER	MARGINAL
---- VAR X3HC07	0.3000	0.6485	1.0000	.
---- VAR X3HC08	0.3000	0.6485	1.0000	.
---- VAR X3HC11	0.3000	0.6485	1.0000	.
---- VAR X3HC14	0.3000	0.6485	1.0000	.
---- VAR X3HC15	0.3000	0.6485	1.0000	.
---- VAR X3HC16	0.3000	0.6485	1.0000	.
---- VAR X3HC22	0.1000	0.6670	0.9000	.
---- VAR X3HC23	0.1000	0.6676	0.9000	.
---- VAR X3HC24	0.1000	0.6673	0.9000	.
---- VAR X3HC25	0.1000	0.6540	0.9000	.
---- VAR X3HC26	0.1000	0.6633	0.9000	.
---- VAR X3HC27	0.1000	0.6730	0.9000	.
---- VAR X3HC28	0.1000	0.5617	0.6000	.
---- VAR X3HC29	0.1000	0.5617	0.6000	.
---- VAR X3HC30	0.1000	0.4951	0.6000	.
---- VAR X3HC31	0.1000	0.5001	0.6000	.
---- VAR X3HC33	0.1000	0.7604	1.0000	.
---- VAR X3HC34	0.1000	0.7604	1.0000	.
---- VAR X3HC38	0.1000	0.7604	1.0000	.
---- VAR X3HC40	0.1000	0.7604	1.0000	.
---- VAR X3HC41	0.1000	0.7604	1.0000	.
---- VAR X3HC45	0.1000	0.7604	1.0000	.
---- VAR X3R1	.	0.5617	0.6000	.
---- VAR X3R29	0.1000	0.5014	0.6000	.
---- VAR X3SC401	0.2000	0.3216	0.4000	.
---- VAR X3SC404	.	0.0234	0.1000	.
---- VAR X3SC405	.	0.0234	0.1000	.
---- VAR X3SC406	.	0.0234	0.1000	.
---- VAR X3SC407	.	0.0234	0.1000	.
---- VAR X3SC409	0.5000	0.9739	1.0000	.
---- VAR X3SC411	0.5000	0.9739	1.0000	.
---- VAR X3SC412	0.5000	0.9739	1.0000	.

----	VAR X3SC413	0.5000	0.9739	1.0000	.
----	VAR X3SC414	0.5000	0.5000	1.0000	-0.0001
----	VAR X4AC09	.	0.0235	0.2000	.
----	VAR X4AC20	.	0.0148	0.2000	.
----	VAR X4AC31	.	0.0087	0.2000	.
----	VAR X4AC42	.	0.0105	0.2000	.
----	VAR X4C301	.	0.1161	0.5000	.
----	VAR X4C302	.	0.0951	0.5000	.
----	VAR X4C303	0.0500	0.1142	0.2000	.
----	VAR X4C306	.	0.1108	0.8000	.
----	VAR X4C307	.	0.1108	0.8000	.
----	VAR X4C308	.	0.1228	0.5000	.

\_Economic Optimization Program

05/15/01 16:49:39 PAGE 171  
GAMS 2.50A Windows NT/95/98

	LOWER	LEVEL	UPPER	MARGINAL	
----	VAR X4C309	.	0.1228	0.4000	.
----	VAR X4C310	.	0.0932	0.3000	.
----	VAR X4C311	.	0.1328	0.5000	.
----	VAR X4C312	.	0.0894	1.0000	.
----	VAR X4C315	0.0001	0.0894	0.3000	.
----	VAR X4C317	.	0.0922	0.2000	.
----	VAR X4C318	0.0001	0.0922	0.3000	.
----	VAR X4C319	0.0001	0.0922	0.3000	.
----	VAR X4C320	0.0001	0.0922	0.3000	.
----	VAR X4C321	0.0001	0.0922	0.3000	.
----	VAR X4C322	.	0.0922	0.4000	.
----	VAR X4C323	0.0100	0.0922	0.2500	.
----	VAR X4C324	0.0100	0.0922	0.2500	.
----	VAR X4C325	.	.	0.1000	.
----	VAR X4C326	.	.	0.1000	.
----	VAR X4C328	.	.	0.1000	.
----	VAR X4C329	.	.	0.1000	.
----	VAR X4C401	0.0010	0.1147	0.5000	.
----	VAR X4C402	0.0010	0.1147	0.5000	.
----	VAR X4C403	0.0001	0.1147	0.3000	.
----	VAR X4C404	0.0001	0.1147	0.3000	.
----	VAR X4C405	0.0001	0.0605	0.2000	.
----	VAR X4C406	.	0.0605	0.2000	.
----	VAR X4C407	0.0100	0.0605	0.3000	.
----	VAR X4C408	.	0.0605	0.2000	.
----	VAR X4C409	.	0.0605	0.3000	.
----	VAR X4C410	0.0001	0.5357	1.0000	.
----	VAR X4C411	.	0.5357	1.0000	.
----	VAR X4C412	0.5000	0.8408	1.0000	.
----	VAR X4C413	0.0001	0.8408	1.0000	.
----	VAR X4C414	0.0100	0.1083	0.2500	.
----	VAR X4C415	0.0001	0.1083	0.3000	.
----	VAR X4C418	0.0001	0.1036	0.3000	.
----	VAR X4C419	0.0001	0.1036	0.3000	.
----	VAR X4C425	.	0.5357	1.0000	.
----	VAR X4C426	0.0001	0.5357	1.0000	.
----	VAR X4C427	.	0.6849	1.0000	.
----	VAR X4C428	.	0.7456	1.0000	.
----	VAR X4C430	0.5000	0.6543	1.0000	.
----	VAR X4C431	0.0001	0.8408	1.0000	.
----	VAR X4C432	0.5000	0.8408	1.0000	.
----	VAR X4HC01	.	0.0886	0.2500	.
----	VAR X4HC02	.	0.0886	0.2500	.
----	VAR X4HC03	.	0.1033	0.3000	.

\_Economic Optimization Program

05/15/01 16:49:39 PAGE 172  
GAMS 2.50A Windows NT/95/98

	LOWER	LEVEL	UPPER	MARGINAL	
----	VAR X4HC04	.	0.1033	0.5000	.
----	VAR X4HC05	.	0.1033	0.5000	.
----	VAR X4HC06	.	0.1001	0.4000	.
----	VAR X4HC07	.	0.1001	0.4000	.
----	VAR X4HC08	.	0.1001	0.4000	.
----	VAR X4HC11	.	0.1001	0.4000	.
----	VAR X4HC14	.	0.1001	0.4000	.
----	VAR X4HC15	.	0.1001	0.4000	.
----	VAR X4HC16	.	0.1001	0.4000	.
----	VAR X4HC22	.	0.1158	0.5000	.
----	VAR X4HC23	.	0.1161	0.5000	.
----	VAR X4HC24	.	0.1159	0.5000	.
----	VAR X4HC25	.	0.1125	0.5000	.
----	VAR X4HC26	.	0.1149	0.5000	.
----	VAR X4HC27	.	0.1172	0.5000	.
----	VAR X4HC28	.	0.1207	0.5000	.
----	VAR X4HC29	.	0.1207	0.3000	.
----	VAR X4HC30	.	0.1140	0.3000	.
----	VAR X4HC31	.	0.1147	0.3000	.
----	VAR X4HC33	.	0.1401	0.5000	.
----	VAR X4HC34	.	0.1401	0.5000	.
----	VAR X4HC38	.	0.1401	0.5000	.
----	VAR X4HC40	.	0.1401	0.5000	.

----	VAR X4HC41	.	0.1401	0.5000	.
----	VAR X4HC45	.	0.1401	0.5000	.
----	VAR X4R1	.	0.1207	0.3000	.
----	VAR X4R29	0.0100	0.1148	0.3000	.
----	VAR X4SC401	0.5000	0.5280	0.7000	.
----	VAR X4SC404	0.4800	0.7666	1.0000	.
----	VAR X4SC405	0.4800	0.7666	1.0000	.
----	VAR X4SC406	0.7000	0.7666	1.0000	.
----	VAR X4SC407	0.7000	0.7666	1.0000	.
----	VAR X4SC409	.	0.0061	0.1000	.
----	VAR X4SC411	.	0.0061	0.1000	.
----	VAR X4SC412	.	0.0061	0.1000	.
----	VAR X4SC413	.	0.0061	0.1000	.
----	VAR X4SC414	.	0.1000	0.1000	0.0094
----	VAR X5AC09	.	0.0062	0.1000	.
----	VAR X5AC20	.	0.0041	0.1000	.
----	VAR X5AC31	.	0.0023	0.1000	.
----	VAR X5AC42	.	0.0028	0.1000	.
----	VAR X5C301	.	0.0179	0.2000	.
----	VAR X5C302	.	0.0056	0.1000	.
----	VAR X5C303	.	0.0167	0.1000	.

\_Economic Optimization Program

05/15/01 16:49:39 PAGE 173  
GAMS 2.50A Windows NT/95/98

	LOWER	LEVEL	UPPER	MARGINAL	
----	VAR X5C306	.	0.0150	0.6000	.
----	VAR X5C307	.	0.0150	0.6000	.
----	VAR X5C308	.	0.0202	0.2000	.
----	VAR X5C309	.	0.0202	0.2000	.
----	VAR X5C310	.	0.0057	0.1000	.
----	VAR X5C311	.	0.0250	0.2000	.
----	VAR X5C312	.	0.0056	0.4000	.
----	VAR X5C315	0.0001	0.0056	0.1000	.
----	VAR X5C317	.	0.0058	0.1000	.
----	VAR X5C318	0.0001	0.0058	0.1000	.
----	VAR X5C319	0.0001	0.0058	0.1000	.
----	VAR X5C320	.	0.0058	0.1000	.
----	VAR X5C321	0.0001	0.0058	0.1000	.
----	VAR X5C322	.	0.0058	0.1000	.
----	VAR X5C323	0.0020	0.0058	0.1000	.
----	VAR X5C324	0.0020	0.0058	0.1000	.
----	VAR X5C325	.	0.0100	0.1000	.
----	VAR X5C326	.	0.0100	0.1000	.
----	VAR X5C328	.	0.0100	0.1000	.
----	VAR X5C329	.	0.0100	0.1000	.
----	VAR X5C401	.	0.0516	0.5000	.
----	VAR X5C402	.	0.0516	0.5000	.
----	VAR X5C403	0.0001	0.0516	0.2000	.
----	VAR X5C404	.	0.0516	0.2000	.
----	VAR X5C405	.	0.1335	0.2000	.
----	VAR X5C406	.	0.1335	0.2000	.
----	VAR X5C407	.	0.1335	0.2000	.
----	VAR X5C408	.	0.1335	0.2000	.
----	VAR X5C409	.	0.1335	0.3000	.
----	VAR X5C410	0.0001	0.0932	1.0000	.
----	VAR X5C411	.	0.0932	1.0000	.
----	VAR X5C412	.	0.0676	0.1000	.
----	VAR X5C413	.	0.0676	0.3000	.
----	VAR X5C414	.	0.0013	0.1000	.
----	VAR X5C415	.	0.0013	0.1000	.
----	VAR X5C418	.	0.0012	0.1000	.
----	VAR X5C419	0.0001	0.0012	0.1000	.
----	VAR X5C425	.	0.0932	1.0000	.
----	VAR X5C426	0.0001	0.0932	1.0000	.
----	VAR X5C427	.	0.0805	1.0000	.
----	VAR X5C428	.	0.0754	0.4000	.
----	VAR X5C430	.	0.0833	0.1000	.
----	VAR X5C431	.	0.0676	0.2000	.
----	VAR X5C432	.	0.0676	0.1000	.

\_Economic Optimization Program

05/15/01 16:49:39 PAGE 174  
GAMS 2.50A Windows NT/95/98

	LOWER	LEVEL	UPPER	MARGINAL	
----	VAR X5HC01	.	0.1422	0.1500	.
----	VAR X5HC02	.	0.1422	0.1500	.
----	VAR X5HC03	.	0.0013	0.1000	.
----	VAR X5HC04	.	0.0013	0.3000	.
----	VAR X5HC05	.	0.0013	0.3000	.
----	VAR X5HC06	.	0.0320	0.3000	.
----	VAR X5HC07	.	0.0320	0.3000	.
----	VAR X5HC08	.	0.0320	0.3000	.
----	VAR X5HC11	.	0.0320	0.3000	.
----	VAR X5HC14	.	0.0320	0.3000	.
----	VAR X5HC15	.	0.0320	0.3000	.
----	VAR X5HC16	.	0.0320	0.3000	.
----	VAR X5HC22	.	0.0310	0.5000	.
----	VAR X5HC23	.	0.0310	0.5000	.
----	VAR X5HC24	.	0.0310	0.5000	.

----	VAR X5HC25	.	0.0313	0.5000	.
----	VAR X5HC26	.	0.0311	0.5000	.
----	VAR X5HC27	.	0.0309	0.5000	.
----	VAR X5HC28	.	0.0463	0.5000	.
----	VAR X5HC29	0.0100	0.0463	0.3000	.
----	VAR X5HC30	.	0.0520	0.3000	.
----	VAR X5HC31	.	0.0516	0.3000	.
----	VAR X5HC33	.	0.0288	2.5000	.
----	VAR X5HC34	.	0.0288	2.5000	.
----	VAR X5HC38	.	0.0288	2.5000	.
----	VAR X5HC40	.	0.0288	2.5000	.
----	VAR X5HC41	.	0.0288	2.5000	.
----	VAR X5HC45	.	0.0288	2.5000	.
----	VAR X5R1	.	0.0463	0.3000	.
----	VAR X5R29	0.0100	0.0516	0.4000	.
----	VAR X5SC401	0.0080	0.0686	0.1000	.
----	VAR X5SC404	.	0.1000	0.1000	.
----	VAR X5SC405	.	0.1000	0.1000	1.9580
----	VAR X5SC406	0.0100	0.1000	0.1000	.
----	VAR X5SC407	0.0100	0.1000	0.1000	.
----	VAR X5SC409	.	.	0.1000	.
----	VAR X5SC411	.	.	0.1000	.
----	VAR X5SC412	.	.	0.1000	.
----	VAR X5SC413	.	.	0.1000	.
----	VAR X5SC414	.	0.1000	0.1000	0.0094
----	VAR X6SC401	.	0.0686	0.1000	.
----	VAR X6SC404	.	0.1000	0.1200	.
----	VAR X6SC405	.	0.1000	0.1000	3.4527
----	VAR X6SC406	.	0.1000	0.1000	.

\_Economic Optimization Program

05/15/01 16:49:39 PAGE 175  
GAMS 2.50A Windows NT/95/98

	LOWER	LEVEL	UPPER	MARGINAL	
----	VAR X6SC407	.	0.1000	0.1000	.
----	VAR X6SC409	.	.	0.1000	.
----	VAR X6SC411	.	.	0.1000	.
----	VAR X6SC412	.	.	0.1000	.
----	VAR X6SC413	.	.	0.1000	.
----	VAR X6SC414	.	0.1000	0.1000	0.0240
----	VAR X7AC09	.	0.0211	0.1000	.
----	VAR X7AC20	.	0.0154	0.1000	.
----	VAR X7AC31	.	0.0082	0.1000	.
----	VAR X7AC42	.	0.0099	0.1000	.
----	VAR X7C301	.	0.0268	0.1000	.
----	VAR X7C302	.	.	0.3000	.
----	VAR X7C303	.	0.0243	0.1000	.
----	VAR X7C306	.	0.0208	0.8000	.
----	VAR X7C307	.	0.0208	0.8000	.
----	VAR X7C308	.	0.0307	0.3000	.
----	VAR X7C309	.	0.0307	0.3000	.
----	VAR X7C310	.	0.0028	0.2000	.
----	VAR X7C311	.	0.0401	1.0000	.
----	VAR X7C312	.	0.0033	0.5000	.
----	VAR X7C315	.	0.0033	0.0100	.
----	VAR X7C316	.	0.0033	0.0100	.
----	VAR X7C317	.	0.0034	0.1000	.
----	VAR X7C318	.	0.0034	0.1500	.
----	VAR X7C319	.	0.0034	0.1500	.
----	VAR X7C320	.	0.0034	0.1000	.
----	VAR X7C321	.	0.0034	0.1000	.
----	VAR X7C322	.	0.0034	0.1000	.
----	VAR X7C323	.	0.0034	0.0200	.
----	VAR X7C324	.	0.0034	0.1000	.
----	VAR X7C325	.	.	0.2000	.
----	VAR X7C326	.	.	0.2000	.
----	VAR X7C328	.	.	0.2000	.
----	VAR X7C329	.	.	0.1000	.
----	VAR X7C401	.	0.3189	1.0000	.
----	VAR X7C402	.	0.3189	0.6000	.
----	VAR X7C403	0.0001	0.3189	1.0000	.
----	VAR X7C404	0.0001	0.3189	1.0000	.
----	VAR X7C405	0.0001	0.8059	1.0000	.
----	VAR X7C406	0.0010	0.8059	1.0000	.
----	VAR X7C407	0.0100	0.8059	1.0000	.
----	VAR X7C408	.	0.8059	1.0000	.
----	VAR X7C409	.	0.8059	1.0000	.
----	VAR X7C410	0.0001	0.3698	1.0000	.

\_Economic Optimization Program

05/15/01 16:49:39 PAGE 176  
GAMS 2.50A Windows NT/95/98

	LOWER	LEVEL	UPPER	MARGINAL	
----	VAR X7C411	.	0.3698	1.0000	.
----	VAR X7C412	.	0.0882	0.2000	.
----	VAR X7C413	.	0.0882	0.3000	.
----	VAR X7C414	.	0.0120	0.1000	.
----	VAR X7C415	.	0.0120	0.1000	.
----	VAR X7C417	0.0001	0.0001	0.0800	-38.1402
----	VAR X7C418	0.0001	0.0106	0.1000	.

----	VAR X7C419	.	0.0106	0.1000	.
----	VAR X7C425	0.2000	0.3698	1.0000	.
----	VAR X7C426	0.0001	0.3698	1.0000	.
----	VAR X7C427	.	0.2328	1.0000	.
----	VAR X7C428	.	0.1771	0.5000	.
----	VAR X7C430	.	0.2603	0.3500	.
----	VAR X7C431	.	0.0882	0.3000	.
----	VAR X7C432	.	0.0882	0.3000	.
----	VAR X7HC01	.	0.6000	0.6000	.
----	VAR X7HC02	.	0.6000	0.6000	34.0552
----	VAR X7HC03	.	0.0104	0.1000	.
----	VAR X7HC04	.	0.0104	0.2500	.
----	VAR X7HC05	.	0.0104	0.2500	.
----	VAR X7HC06	.	0.1389	0.3000	.
----	VAR X7HC07	.	0.1389	0.3000	.
----	VAR X7HC08	.	0.1389	0.3000	.
----	VAR X7HC11	.	0.1389	0.3000	.
----	VAR X7HC14	.	0.1389	0.3000	.
----	VAR X7HC15	.	0.1389	0.3000	.
----	VAR X7HC16	.	0.1389	0.3000	.
----	VAR X7HC22	.	0.1397	0.5000	.
----	VAR X7HC23	.	0.1391	0.5000	.
----	VAR X7HC24	.	0.1394	0.5000	.
----	VAR X7HC25	.	0.1525	0.5000	.
----	VAR X7HC26	.	0.1434	0.5000	.
----	VAR X7HC27	.	0.1340	0.5000	.
----	VAR X7HC28	.	0.2525	0.5000	.
----	VAR X7HC29	0.1000	0.2525	0.5000	.
----	VAR X7HC30	0.1000	0.3246	0.5000	.
----	VAR X7HC31	0.1000	0.3189	0.6000	.
----	VAR X7HC33	.	0.0479	2.0000	.
----	VAR X7HC34	.	0.0479	2.0000	.
----	VAR X7HC38	.	0.0479	2.0000	.
----	VAR X7HC40	.	0.0479	2.0000	.
----	VAR X7HC41	.	0.0479	2.0000	.
----	VAR X7HC45	.	0.0479	2.0000	.
----	VAR X7R1	.	0.2525	0.5000	.

\_Economic Optimization Program

05/15/01 16:49:39 PAGE 177  
GAMS 2.50A Windows NT/95/98

	LOWER	LEVEL	UPPER	MARGINAL	
----	VAR X7R29	0.1000	0.3175	0.6000	.
----	VAR X7SC401	.	0.0069	0.1000	.
----	VAR X7SC404	.	0.0100	0.1200	.
----	VAR X7SC405	.	0.0100	0.1200	.
----	VAR X7SC406	.	0.0100	0.0100	2.9674
----	VAR X7SC407	.	0.0100	0.1000	.
----	VAR X7SC409	.	.	0.1000	.
----	VAR X7SC411	.	.	0.1000	.
----	VAR X7SC412	.	.	0.1000	.
----	VAR X7SC413	.	.	0.1000	.
----	VAR X7SC414	.	0.1000	0.1000	0.0240
----	VAR X8AC09	.	4.6550938E-6	0.1000	.
----	VAR X8AC20	.	5.7557385E-6	0.1000	.
----	VAR X8AC31	.	4.7975916E-6	0.1000	.
----	VAR X8AC42	.	4.8789678E-6	0.1000	.
----	VAR X9AC09	.	0.0058	0.3000	.
----	VAR X9AC20	.	0.0046	0.3000	.
----	VAR X9AC31	.	0.0023	0.3000	.
----	VAR X9AC42	.	0.0028	0.3000	.
----	VAR XAC02	0.4000	0.4999	1.0000	.
----	VAR XAC05	0.4000	0.4978	1.0000	.
----	VAR XAC07	0.4000	0.4979	1.0000	.
----	VAR XAC09	0.4000	0.4809	1.0000	.
----	VAR XAC12	0.4000	0.4978	1.0000	.
----	VAR XAC15	0.4000	0.4959	1.0000	.
----	VAR XAC18	0.4000	0.4959	1.0000	.
----	VAR XAC20	0.4000	0.4854	1.0000	.
----	VAR XAC23	0.4000	0.4959	1.0000	.
----	VAR XAC26	0.4000	0.4938	1.0000	.
----	VAR XAC29	0.4000	0.4939	1.0000	.
----	VAR XAC31	0.4000	0.4880	1.0000	.
----	VAR XAC34	0.4000	0.4938	1.0000	.
----	VAR XAC37	0.4000	0.4917	1.0000	.
----	VAR XAC40	0.4000	0.4917	1.0000	.
----	VAR XAC42	0.4000	0.4844	1.0000	.
----	VAR XIC10AC09	.	.	1.0000	.
----	VAR XIC10AC20	.	.	1.0000	.
----	VAR XIC10AC31	.	.	1.0000	.
----	VAR XIC10AC42	.	.	1.0000	.
----	VAR XIC11AC09	.	.	1.0000	.
----	VAR XIC11AC20	.	.	1.0000	.
----	VAR XIC11AC31	.	.	1.0000	.
----	VAR XIC11AC42	.	.	1.0000	.
----	VAR XM1C606D	.	0.0002	0.5000	.

\_Economic Optimization Program

05/15/01 16:49:39 PAGE 178  
GAMS 2.50A Windows NT/95/98

	LOWER	LEVEL	UPPER	MARGINAL
--	-------	-------	-------	----------

----	VAR XM3C606D	0.0008	0.5000	.
----	VAR XM4C606D	0.5575	0.6500	.
----	VAR XM5C606D	0.0980	0.5000	.
----	VAR XM7C606D	0.3436	1.0000	.
----	VAR XX1C302	0.1003	0.2500	.
----	VAR XX1C308	0.0621	0.5000	.
----	VAR XX1C310	0.1193	0.5000	.
----	VAR XX1C311	0.0422	0.3000	.
----	VAR XX1C312	0.1485	1.0000	.
----	VAR XX1C323	0.1133	0.2000	.
----	VAR XX1C325	0.4000	1.0000	1.0000
----	VAR XX1C405	.	0.0100	.
----	VAR XX1C408	.	1.0000	.
----	VAR XX1C425	0.0005	1.0000	.
----	VAR XX1C428	0.0006	1.0000	.
----	VAR XX1C430	0.0007	0.5000	.
----	VAR XX1C431	0.0020	0.1000	.
----	VAR XX1HC28	0.0100	0.0270	0.2000
----	VAR XX1HC29	.	0.0270	0.2000
----	VAR XX1HC30	0.0100	0.0213	0.2000
----	VAR XX1HC32	.	0.0305	0.1000
----	VAR XX1R1	0.0270	0.2000	.
----	VAR XX1R29	0.0218	0.1000	.
----	VAR XX1SC406	.	0.2000	.
----	VAR XX1SC408	0.0262	0.1000	.
----	VAR XX2HC28	.	0.1000	.
----	VAR XX2HC29	.	0.1000	.
----	VAR XX2HC30	.	0.1000	-0.0576
----	VAR XX2R1	.	0.1000	.
----	VAR XX2R29	.	0.1000	EPS
----	VAR XX2SC406	.	0.1000	.
----	VAR XX2SC408	.	1.0000	.
----	VAR XX3C302	0.5000	0.8024	1.0000
----	VAR XX3C308	.	0.7783	1.0000
----	VAR XX3C310	.	0.7837	1.0000
----	VAR XX3C311	.	0.7764	1.0000
----	VAR XX3C312	.	0.7587	1.0000
----	VAR XX3C323	0.5000	0.7900	0.9200
----	VAR XX3C325	.	1.2128590E-6	0.5000
----	VAR XX3C405	.	2.3780783E-5	0.1000
----	VAR XX3C408	.	2.3780783E-5	1.0000
----	VAR XX3C425	.	0.0011	1.0000
----	VAR XX3C428	.	0.0015	1.0000
----	VAR XX3C430	.	0.0017	0.1000

\_Economic Optimization Program

05/15/01 16:49:39 PAGE 179  
GAMS 2.50A Windows NT/95/98

	LOWER	LEVEL	UPPER	MARGINAL
----	VAR XX3C431	.	0.0021	0.5000
----	VAR XX3C432	.	0.0021	0.1500
----	VAR XX3HC28	0.2000	0.6141	0.8000
----	VAR XX3HC29	0.1000	0.6141	0.8000
----	VAR XX3HC30	0.1000	0.5571	0.6000
----	VAR XX3HC32	0.3000	0.7712	1.0000
----	VAR XX3R1	0.1000	0.6141	0.8000
----	VAR XX3R29	0.1000	0.5626	0.6000
----	VAR XX3SC406	.	0.0245	0.1000
----	VAR XX3SC408	0.5000	0.9678	1.0000
----	VAR XX4C302	.	0.0929	0.5000
----	VAR XX4C308	.	0.1227	0.5000
----	VAR XX4C310	.	0.0907	0.3000
----	VAR XX4C311	.	0.1338	0.5000
----	VAR XX4C312	.	0.0863	0.1500
----	VAR XX4C323	0.0800	0.0899	0.2800
----	VAR XX4C325	.	.	0.0500
----	VAR XX4C405	0.0001	0.0851	0.2000
----	VAR XX4C408	.	0.0851	0.3000
----	VAR XX4C409	0.0001	0.0851	0.3000
----	VAR XX4C425	.	0.6219	1.0000
----	VAR XX4C427	.	0.7538	1.0000
----	VAR XX4C428	.	0.8037	1.0000
----	VAR XX4C430	0.5000	0.7278	1.0000
----	VAR XX4C431	0.0001	0.8771	1.0000
----	VAR XX4C432	0.5000	0.8771	1.0000
----	VAR XX4HC28	0.0100	0.1320	0.3000
----	VAR XX4HC29	0.0100	0.1320	0.3000
----	VAR XX4HC30	0.0100	0.1283	0.3000
----	VAR XX4HC32	.	0.1421	0.5000
----	VAR XX4R1	.	0.1320	0.3000
----	VAR XX4R29	0.0100	0.1288	0.3000
----	VAR XX4SC406	0.6000	0.8003	1.0000
----	VAR XX4SC408	.	0.0060	0.0500
----	VAR XX5C302	.	0.0044	0.1000
----	VAR XX5C308	.	0.0163	0.8000
----	VAR XX5C310	.	0.0045	0.1000
----	VAR XX5C311	.	0.0203	0.1000
----	VAR XX5C312	.	0.0044	0.3000
----	VAR XX5C323	0.0010	0.0046	0.1500
----	VAR XX5C325	.	.	0.0010

```

---- VAR XX5C405      0.0001    0.1512    0.2000
---- VAR XX5C408      .          0.1512    0.3000
---- VAR XX5C425      .          0.0872    1.0000
_Economic Optimization Program

```

05/15/01 16:49:39 PAGE 180  
GAMS 2.50A Windows NT/95/98

	LOWER	LEVEL	UPPER	MARGINAL
---- VAR XX5C428	.	0.0655	1.0000	.
---- VAR XX5C430	.	0.0747	1.0000	.
---- VAR XX5C431	.	0.0568	1.0000	.
---- VAR XX5HC28	0.0100	0.0408	0.3000	.
---- VAR XX5HC29	.	0.0408	0.3000	.
---- VAR XX5HC30	.	0.0471	0.3000	.
---- VAR XX5HC32	.	0.0235	0.2000	.
---- VAR XX5R1	.	0.0408	0.3000	.
---- VAR XX5R29	.	0.0466	0.3000	.
---- VAR XX5SC406	.	0.0841	0.1500	.
---- VAR XX5SC408	.	.	0.1000	.
---- VAR XX6SC406	.	0.0841	0.1000	.
---- VAR XX6SC408	.	.	1.0000	-4.0268
---- VAR XX7C302	.	.	0.2000	-0.7740
---- VAR XX7C308	.	0.0207	0.1000	.
---- VAR XX7C310	.	0.0018	0.1000	.
---- VAR XX7C311	.	0.0272	0.3000	.
---- VAR XX7C312	.	0.0021	0.1000	.
---- VAR XX7C323	0.0020	0.0022	0.1000	.
---- VAR XX7C325	.	.	0.1000	-31.8651
---- VAR XX7C405	0.0001	0.7636	1.0000	.
---- VAR XX7C408	.	0.7636	1.0000	.
---- VAR XX7C425	.	0.2893	1.0000	.
---- VAR XX7C428	.	0.1287	1.0000	.
---- VAR XX7C430	.	0.1952	1.0000	.
---- VAR XX7C431	.	0.0620	1.0000	.
---- VAR XX7HC28	0.1000	0.1861	0.4000	.
---- VAR XX7HC29	.	0.1861	0.5000	.
---- VAR XX7HC30	0.1000	0.2462	0.5000	.
---- VAR XX7HC32	.	0.0327	0.2000	.
---- VAR XX7R1	0.1000	0.1861	0.5000	.
---- VAR XX7R29	0.1000	0.2402	0.5000	.
---- VAR XX7SC406	.	0.0070	0.1000	.
---- VAR XX7SC408	.	.	0.1000	.
---- VAR Y1HC28	0.0500	0.0771	0.5000	.
---- VAR Y1HC29	0.0500	0.0771	0.5000	.
---- VAR Y1HC30	0.0500	0.0665	0.5000	.
---- VAR Y1HC31	0.0500	0.0671	0.4000	.
---- VAR Y1R1	.	0.0771	0.5000	.
---- VAR Y1R29	0.0500	0.0673	0.5000	.
---- VAR Y2HC28	.	.	0.1000	.
---- VAR Y2HC29	.	.	0.1000	.
---- VAR Y2HC30	.	.	0.1000	.
---- VAR Y2HC31	.	.	0.1000	.

05/15/01 16:49:39 PAGE 181  
GAMS 2.50A Windows NT/95/98

	LOWER	LEVEL	UPPER	MARGINAL
---- VAR Y2R1	.	.	0.1000	.
---- VAR Y2R29	.	.	0.1000	.
---- VAR Y3HC28	0.2000	0.7795	0.9000	.
---- VAR Y3HC29	0.1000	0.7795	0.9000	.
---- VAR Y3HC30	0.1000	0.7713	0.8500	.
---- VAR Y3HC31	0.1000	0.7721	0.8500	.
---- VAR Y3R1	0.1000	0.7795	0.9000	.
---- VAR Y3R29	0.1000	0.7723	0.8500	.
---- VAR Y4HC28	.	0.1099	0.5000	.
---- VAR Y4HC29	.	0.1099	0.3000	.
---- VAR Y4HC30	0.0100	0.1165	0.4000	.
---- VAR Y4HC31	.	0.1161	0.3000	.
---- VAR Y4R1	.	0.1099	0.3000	.
---- VAR Y4R29	.	0.1160	0.5000	.
---- VAR Y5HC28	.	0.0144	0.2000	.
---- VAR Y5HC29	.	0.0144	0.2000	.
---- VAR Y5HC30	.	0.0181	0.2000	.
---- VAR Y5HC31	.	0.0179	0.2000	.
---- VAR Y5R1	.	0.0144	0.2000	.
---- VAR Y5R29	.	0.0178	0.2000	.
---- VAR Y7HC28	0.0100	0.0191	0.5000	.
---- VAR Y7HC29	.	0.0191	0.1000	.
---- VAR Y7HC30	.	0.0275	0.1000	.
---- VAR Y7HC31	.	0.0268	0.2000	.
---- VAR Y7R1	.	0.0191	0.1000	.
---- VAR Y7R29	.	0.0266	0.2000	.
---- VAR YY1HC28	0.1000	0.1000	0.5000	.
---- VAR YY1HC29	0.1000	0.1000	0.6000	.
---- VAR YY1HC30	0.0500	0.0869	0.6000	.
---- VAR YY1R1	0.1000	0.1000	0.6000	-23.5298
---- VAR YY1R29	0.0500	0.0878	0.6000	.
---- VAR YY2HC28	.	.	0.1000	.
---- VAR YY2HC29	.	.	0.1000	.

----	VAR YY2HC30	.	.	0.1000	.
----	VAR YY2R1	.	.	0.1000	.
----	VAR YY2R29	.	.	0.1000	.
----	VAR YY3HC28	0.1000	0.7677	0.9000	.
----	VAR YY3HC29	0.1000	0.7677	0.8000	.
----	VAR YY3HC30	0.1000	0.7647	0.8000	.
----	VAR YY3R1	0.1000	0.7677	0.8000	.
----	VAR YY3R29	0.1000	0.7652	0.8000	.
----	VAR YY4HC28	0.0100	0.1082	0.3000	.
----	VAR YY4HC29	0.0100	0.1082	0.3000	.
----	VAR YY4HC30	0.0100	0.1155	0.3000	.

\_Economic Optimization Program

05/15/01 16:49:39 PAGE 182  
GAMS 2.50A Windows NT/95/98

	LOWER	LEVEL	UPPER	MARGINAL
----	VAR YY4R1	.	0.1082	0.3000
----	VAR YY4R29	0.0100	0.1150	0.3000
----	VAR YY5HC28	0.0010	0.0114	0.2000
----	VAR YY5HC29	.	0.0114	0.2000
----	VAR YY5HC30	.	0.0145	0.1000
----	VAR YY5R1	.	0.0114	0.2000
----	VAR YY5R29	.	0.0142	0.2000
----	VAR YY7HC28	.	0.0127	0.2000
----	VAR YY7HC29	.	0.0127	0.2000
----	VAR YY7HC30	.	0.0184	0.1000
----	VAR YY7R1	.	0.0127	0.1000
----	VAR YY7R29	.	0.0178	0.2000

FAC02  
FAC12  
FAC23  
FAC34  
FAC45  
FC308  
FC316  
FC320  
FC322  
FC328  
FC329  
FC403  
FC407  
FC412  
FC417  
FHC01  
FHC32  
FSC402  
FSC405  
FSC411  
FSC413  
FSTME612  
PC302  
PC310  
PC601  
PC603  
QHC07  
QHC11  
QHC14  
QHC16  
QHC34

\_Economic Optimization Program

05/15/01 16:49:39 PAGE 183  
GAMS 2.50A Windows NT/95/98

QHC38  
QHC41  
QHC45  
TAC09  
TAC12  
TAC23  
TAC31  
TAC34  
TAC42  
TAC45  
TC303  
TC306  
TC307  
TC308  
TC315  
TC316  
TC317  
TC321  
TC324  
TC325  
TC404  
TC405  
TC407  
TC408  
TC410  
TC414  
TC418



TC419  
THC32  
TSC402  
TSC403  
TSC405  
TSC408  
TSC413  
X11AC12  
X11AC23  
X11AC34  
X11AC45  
X1C316  
X1C325  
X1C417  
X1HC32  
X1SC402  
X1SC403  
X1SC408  
X2SC402  
\_Economic Optimization Program

05/15/01 16:49:39 PAGE 184  
GAMS 2.50A Windows NT/95/98

X2SC403  
X2SC408  
X3C316  
X3C325  
X3C417  
X3HC32  
X3SC402  
X3SC403  
X3SC408  
X4C316  
X4C417  
X4HC32  
X4SC402  
X4SC403  
X4SC408  
X5C316  
X5C417  
X5HC32  
X5SC402  
X5SC403  
X5SC408  
X6SC402  
X6SC403  
X6SC408  
X7HC32  
X7SC402  
X7SC403  
X7SC408  
XX1C322  
XX1C414  
XX1HC01  
XX2HC01  
XX3C317  
XX3C322  
XX3C407  
XX3C412  
XX3C414  
XX3HC01  
XX4C317  
XX4C322  
XX4C407  
XX4C412  
XX4C414  
XX4HC01  
XX5C407  
XX5C412  
\_Economic Optimization Program

05/15/01 16:49:39 PAGE 185  
GAMS 2.50A Windows NT/95/98

XX5C414  
XX7C414  
OBJVAR objective or profit function  
C10PC623  
C10PC625  
C10PC627  
C10PC629  
C2C623  
C2C625  
C2C627  
C2C629  
C3C623  
C3C625  
C3C627  
C3C629  
C3PC623  
C3PC625  
C3PC627  
C3PC629

C4PC623  
C4PC625  
C4PC627  
C4PC629  
C5PC623  
C5PC625  
C5PC627  
C5PC629  
C7PC623  
C7PC625  
C7PC627  
C7PC629  
C8PC623  
C8PC625  
C8PC627  
C8PC629  
C9PC623  
C9PC625  
C9PC627  
C9PC629  
CHXC623  
CHXC625  
CHXC627  
CHXC629  
CIC10PC623  
CIC10PC625  
CIC10PC627  
\_Economic Optimization Program

05/15/01 16:49:39 PAGE 186  
GAMS 2.50A Windows NT/95/98

CIC10PC629  
CIC11PC623  
CIC11PC625  
CIC11PC627  
CIC11PC629  
CIC4EC623  
CIC4EC625  
CIC4EC627  
CIC4EC629  
CIC5EC623  
CIC5EC625  
CIC5EC627  
CIC5EC629  
CIC8EC623  
CIC8EC625  
CIC8EC627  
CIC8EC629  
COST  
DTE601  
DTE602  
DTE603  
DTE605  
DTE609A  
DTE610  
DTE611  
DTE612  
DTE613  
DTE616  
DTE617  
DTE621A  
DTE621B  
DTE626  
DTE627A  
DTE627B  
DTE628  
DTE629  
DTE633  
DTE634  
DTE640  
DTE641  
DTE695A  
DTE695B  
DTE696A  
DTE696B  
DTE6XX  
EARNINGS  
\_Economic Optimization Program

05/15/01 16:49:39 PAGE 187  
GAMS 2.50A Windows NT/95/98

F1C601  
F1C603  
F1C606A  
F2C601  
F3C601  
F3C603  
F3C606A  
F4C601  
F4C603  
F4C606A  
F5C601

F5C603  
F5C606A  
F6C601  
F7C601  
F7C603  
F7C606A  
FAC05  
FAC07  
FAC09  
FAC15  
FAC18  
FAC20  
FAC26  
FAC29  
FAC31  
FAC37  
FAC40  
FAC42  
FC301  
FC302  
FC303  
FC306  
FC307  
FC309  
FC310  
FC311  
FC312  
FC315  
FC317  
FC318  
FC319  
FC321  
FC323  
FC324  
FC325

\_\_Economic Optimization Program

05/15/01 16:49:39 PAGE 188  
GAMS 2.50A Windows NT/95/98

FC326  
FC401  
FC402  
FC404  
FC405  
FC406  
FC408  
FC409  
FC410  
FC411  
FC413  
FC414  
FC415  
FC418  
FC419  
FC425  
FC426  
FC427  
FC428  
FC430  
FC431  
FC432  
FCWE603  
FCWE605  
FCWE609A  
FCWE611  
FCWE613  
FCWE617  
FCWE621A  
FCWE621B  
FCWE626  
FCWE627A  
FCWE627B  
FCWE634  
FCWE640  
FCWE641A  
FCWE641B  
FHC02  
FHC03  
FHC04  
FHC05  
FHC06  
FHC07  
FHC08  
FHC11  
FHC14

\_\_Economic Optimization Program

05/15/01 16:49:39 PAGE 189  
GAMS 2.50A Windows NT/95/98

FHC15  
FHC16  
FHC22

FHC23  
FHC24  
FHC25  
FHC26  
FHC27  
FHC28  
FHC29  
FHC30  
FHC31  
FHC33  
FHC34  
FHC38  
FHC40  
FHC41  
FHC45  
FLHC28  
FLHC29  
FLHC30  
FLHC31  
FLR1  
FLR29  
FMC302  
FMC308  
FMC310  
FMC311  
FMC312  
FMC317  
FMC322  
FMC323  
FMC325  
FMC405  
FMC407  
FMC408  
FMC409  
FMC412  
FMC414  
FMC425  
FMC427  
FMC428  
FMC430  
FMC431  
FMC432  
FMHC01  
\_Economic Optimization Program

05/15/01 16:49:39 PAGE 190  
GAMS 2.50A Windows NT/95/98

FMHC32  
FMLHC28  
FMLHC29  
FMLHC30  
FMLR1  
FMLR29  
FMSC403  
FMSC406  
FMSC408  
FMVHC28  
FMVHC29  
FMVHC30  
FMVR1  
FMVR29  
FR1  
FR29  
FSC401  
FSC403  
FSC404  
FSC406  
FSC407  
FSC408  
FSC409  
FSC412  
FSC414  
FSTME602  
FSTME695A  
FSTME695B  
FSTME696A  
FSTME696B  
FVHC28  
FVHC29  
FVHC30  
FVHC31  
FVR1  
FVR29  
H1C601  
H1C603  
H1C606A  
H2C601  
H3C601  
H3C603  
H3C606A  
H4C601  
H4C603

H5C601  
H5C603  
H5C606A  
H6C601  
H7C601  
H7C603  
H7C606A  
HAC02  
HAC05  
HAC07  
HAC09  
HAC12  
HAC15  
HAC18  
HAC20  
HAC23  
HAC26  
HAC29  
HAC31  
HAC34  
HAC37  
HAC40  
HAC42  
HACAC09  
HACAC20  
HACAC31  
HACAC42  
HC301  
HC302  
HC303  
HC306  
HC307  
HC308  
HC309  
HC310  
HC311  
HC312  
HC312LIQ  
HC315  
HC316  
HC317  
HC318  
HC319  
HC321  
HC322  
HC323

HC324  
HC325  
HC326  
HC329  
HC401  
HC402  
HC403  
HC404  
HC405  
HC406  
HC407  
HC408  
HC408VAP  
HC409  
HC410  
HC410VAP  
HC411  
HC412  
HC412LIQ  
HC413  
HC414  
HC414LIQ  
HC415  
HC417  
HC418  
HC419  
HC425  
HC426  
HC427  
HC428  
HC430  
HC431  
HC432  
HC623  
HC625  
HC627  
HC629

HHC01  
HHC02  
HHC03  
HHC04  
HHC05  
HHC06  
HHC07  
HHC11  
HHC14  
\_Economic Optimization Program

05/15/01 16:49:39 PAGE 193  
GAMS 2.50A Windows NT/95/98

HHC16  
HHC29  
HHC30  
HHC31  
HHC32  
HHC34  
HHC38  
HHC41  
HHC45  
HLHC29  
HLHC30  
HLHC31  
HLR1  
HLR29  
HR1  
HR29  
HSC401  
HSC402  
HSC403  
HSC404  
HSC405  
HSC406  
HSC407  
HSC408  
HSC409  
HSC411  
HSC412  
HSC413  
HSC414  
HVHC29  
HVHC30  
HVHC31  
HVR1  
HVR29  
K1C323  
K1C325  
K1C408  
K1C414  
K1C428  
K1C430  
K1C601  
K1C603  
K1C606A  
K1C606C  
K1C614B  
K1C615\_A  
\_Economic Optimization Program

05/15/01 16:49:39 PAGE 194  
GAMS 2.50A Windows NT/95/98

K1C616\_A  
K1E633  
K1E6XX  
K1SC406  
K1SC408  
K2C601  
K2E633  
K2E6XX  
K2SC406  
K2SC408  
K3C323  
K3C325  
K3C408  
K3C414  
K3C428  
K3C430  
K3C601  
K3C603  
K3C606A  
K3C606C  
K3C614B  
K3C615\_A  
K3C616\_A  
K3E633  
K3E6XX  
K3SC406  
K3SC408  
K4C323  
K4C325

K4C408  
K4C414  
K4C428  
K4C430  
K4C601  
K4C603  
K4C606A  
K4C606C  
K4C614B  
K4C615\_A  
K4C616\_A  
K4E633  
K4E6XX  
K4SC406  
K4SC408  
K5C323  
K5C325  
\_Economic Optimization Program

05/15/01 16:49:39 PAGE 195  
GAMS 2.50A Windows NT/95/98

K5C408  
K5C414  
K5C428  
K5C430  
K5C601  
K5C603  
K5C606A  
K5C606C  
K5C614B  
K5C615\_A  
K5C616\_A  
K5E633  
K5E6XX  
K5SC406  
K5SC408  
K6C601  
K6SC406  
K6SC408  
K7C323  
K7C325  
K7C408  
K7C414  
K7C428  
K7C430  
K7C601  
K7C603  
K7C606A  
K7C614B  
K7C615\_A  
K7C616\_A  
K7E633  
K7E6XX  
K7SC406  
K7SC408  
KP1C601  
KP1C603  
KP1C606A  
KP1C606D  
KP2C601  
KP3C601  
KP3C603  
KP3C606A  
KP3C606D  
KP4C601  
KP4C603  
KP4C606A  
\_Economic Optimization Program

05/15/01 16:49:39 PAGE 196  
GAMS 2.50A Windows NT/95/98

KP4C606D  
KP5C601  
KP5C603  
KP5C606A  
KP5C606D  
KP6C601  
KP7C601  
KP7C603  
KP7C606A  
KP7C606D  
KWAD1  
KWAD2  
LPC601  
LPC603  
LPC606A  
PC303  
PC306  
PC307  
PC308  
PC309  
PC311

PC312  
PHC30  
PHC32  
PR29  
PROFIT  
Q2HC07  
Q2HC11  
Q2HC14  
Q2HC16  
QFP1C606A  
QFP3C606A  
QFP4C606A  
QFP5C606A  
QFP7C606A  
QS1C606A  
QS3C606A  
QS4C606A  
QS5C606A  
QS7C606A  
R10C623  
R10C625  
R10C627  
R10C629  
R2C623  
R2C625  
\_Economic Optimization Program

05/15/01 16:49:39 PAGE 197  
GAMS 2.50A Windows NT/95/98

R2C627  
R2C629  
R3C623  
R3C625  
R3C627  
R3C629  
R4C623  
R4C625  
R4C627  
R4C629  
R5C623  
R5C625  
R5C627  
R5C629  
R7C623  
R7C625  
R7C627  
R7C629  
R8C623  
R8C625  
R8C627  
R8C629  
R9C623  
R9C625  
R9C627  
R9C629  
RHO2HC07  
RHO2HC11  
RHO2HC14  
RHO2HC16  
RHOAC09  
RHOAC20  
RHOAC31  
RHOAC42  
RIC10C623  
RIC10C625  
RIC10C627  
RIC10C629  
RIC11C623  
RIC11C625  
RIC11C627  
RIC11C629  
SF1S34  
SF2S34  
SFS11  
SFS19  
\_Economic Optimization Program

05/15/01 16:49:39 PAGE 198  
GAMS 2.50A Windows NT/95/98

SFS2  
SFS23  
SFS27  
SFS41  
SFS42  
SFS5  
SFS7  
SM1C601  
SM1C603  
SM1C606A  
SM1C606D  
SM2C601  
SM3C601



SM3C603  
SM3C606A  
SM3C606D  
SM4C601  
SM4C603  
SM4C606A  
SM4C606D  
SM5C601  
SM5C603  
SM5C606A  
SM5C606D  
SM6C601  
SM7C601  
SM7C603  
SM7C606A  
SM7C606D  
SN1C601  
SN1C603  
SN1C606A  
SN2C601  
SN3C601  
SN3C603  
SN3C606A  
SN4C601  
SN4C603  
SN4C606A  
SN5C601  
SN5C603  
SN5C606A  
SN6C601  
SN7C601  
SN7C603  
SN7C606A

\_\_Economic Optimization Program

05/15/01 16:49:39 PAGE 199  
GAMS 2.50A Windows NT/95/98

TAC02  
TAC05  
TAC07  
TAC15  
TAC18  
TAC20  
TAC26  
TAC29  
TAC37  
TAC40  
TC301  
TC302  
TC309  
TC310  
TC311  
TC312  
TC318  
TC319  
TC320  
TC322  
TC323  
TC326  
TC328  
TC329  
TC401  
TC402  
TC403  
TC406  
TC409  
TC411  
TC412  
TC413  
TC415  
TC417  
TC425  
TC426  
TC427  
TC428  
TC430  
TC431  
TC432  
TCWOTE609A  
TCWOTE621A  
TCWOTE621B  
TCWOTE627A  
TCWOTE627B

\_\_Economic Optimization Program

05/15/01 16:49:39 PAGE 200  
GAMS 2.50A Windows NT/95/98

TCWOTE641A  
TCWOTE641B  
TCWOUTE603  
TCWOUTE605  
TCWOUTE611

TCWOUTE613  
TCWOUTE617  
TCWOUTE626  
TCWOUTE634  
TCWOUTE640  
THC01  
THC02  
THC03  
THC04  
THC05  
THC06  
THC07  
THC11  
THC14  
THC16  
THC22  
THC23  
THC24  
THC25  
THC26  
THC27  
THC28  
THC29  
THC30  
THC31  
THC34  
THC38  
THC41  
THC45  
TMC601  
TMC603  
TMC606A  
TMC606D  
TMK601  
TNC601  
TNC603  
TNC606A  
TR1  
TR29  
TSC401  
TSC404

\_\_Economic Optimization Program

05/15/01 16:49:39 PAGE 201  
GAMS 2.50A Windows NT/95/98

TSC406  
TSC407  
TSC409  
TSC411  
TSC412  
TSC414  
UTILITIES  
VFC614B  
VFC615  
VFC616  
VFM3  
VPC601  
VPC603  
VPC606A  
X10AC09  
X10AC20  
X10AC31  
X10AC42  
X11AC02  
X11AC05  
X11AC07  
X11AC09  
X11AC15  
X11AC18  
X11AC20  
X11AC26  
X11AC29  
X11AC31  
X11AC37  
X11AC40  
X11AC42  
X12AC02  
X12AC05  
X12AC07  
X12AC09  
X12AC12  
X12AC15  
X12AC18  
X12AC20  
X12AC23  
X12AC26  
X12AC29  
X12AC31  
X12AC34  
X12AC37  
X12AC40

\_\_Economic Optimization Program

05/15/01 16:49:39 PAGE 202

X12AC42  
X12AC45  
X1AC09  
X1AC20  
X1AC31  
X1AC42  
X1C301  
X1C302  
X1C303  
X1C306  
X1C307  
X1C308  
X1C309  
X1C310  
X1C311  
X1C312  
X1C315  
X1C317  
X1C318  
X1C319  
X1C320  
X1C321  
X1C322  
X1C323  
X1C324  
X1C326  
X1C328  
X1C329  
X1C401  
X1C402  
X1C403  
X1C404  
X1C405  
X1C406  
X1C407  
X1C408  
X1C409  
X1C410  
X1C411  
X1C412  
X1C413  
X1C414  
X1C415  
X1C418  
X1C419  
X1C425

\_Economic Optimization Program

X1C426  
X1C427  
X1C428  
X1C430  
X1C431  
X1C432  
X1HC01  
X1HC02  
X1HC03  
X1HC04  
X1HC05  
X1HC06  
X1HC07  
X1HC08  
X1HC11  
X1HC14  
X1HC15  
X1HC16  
X1HC22  
X1HC23  
X1HC24  
X1HC25  
X1HC26  
X1HC27  
X1HC28  
X1HC29  
X1HC30  
X1HC31  
X1HC33  
X1HC34  
X1HC38  
X1HC40  
X1HC41  
X1HC45  
X1R1  
X1R29  
X1SC401  
X1SC404  
X1SC405

X1SC406  
X1SC407  
X1SC409  
X1SC411  
X1SC412  
X1SC413  
X1SC414

\_Economic Optimization Program

05/15/01 16:49:39 PAGE 204  
GAMS 2.50A Windows NT/95/98

X2AC09  
X2AC20  
X2AC31  
X2AC42  
X2C301  
X2C417  
X2C418  
X2C419  
X2HC01  
X2HC02  
X2HC03  
X2HC04  
X2HC05  
X2HC06  
X2HC07  
X2HC08  
X2HC11  
X2HC14  
X2HC15  
X2HC16  
X2HC22  
X2HC23  
X2HC24  
X2HC25  
X2HC26  
X2HC27  
X2HC28  
X2HC29  
X2HC30  
X2HC31  
X2R1  
X2R29  
X2SC401  
X2SC404  
X2SC405  
X2SC406  
X2SC407  
X2SC409  
X2SC411  
X2SC412  
X2SC413  
X2SC414  
X3AC09  
X3AC20  
X3AC31  
X3AC42

\_Economic Optimization Program

05/15/01 16:49:39 PAGE 205  
GAMS 2.50A Windows NT/95/98

X3C301  
X3C302  
X3C303  
X3C306  
X3C307  
X3C308  
X3C309  
X3C310  
X3C311  
X3C312  
X3C315  
X3C317  
X3C318  
X3C319  
X3C320  
X3C321  
X3C322  
X3C323  
X3C324  
X3C326  
X3C328  
X3C329  
X3C401  
X3C402  
X3C403  
X3C404  
X3C405  
X3C406  
X3C407  
X3C408  
X3C409

X3C410  
X3C411  
X3C412  
X3C413  
X3C414  
X3C415  
X3C418  
X3C419  
X3C425  
X3C426  
X3C427  
X3C428  
X3C430  
X3C431  
X3C432

\_Economic Optimization Program

05/15/01 16:49:39 PAGE 206  
GAMS 2.50A Windows NT/95/98

X3HC01  
X3HC02  
X3HC03  
X3HC04  
X3HC05  
X3HC06  
X3HC07  
X3HC08  
X3HC11  
X3HC14  
X3HC15  
X3HC16  
X3HC22  
X3HC23  
X3HC24  
X3HC25  
X3HC26  
X3HC27  
X3HC28  
X3HC29  
X3HC30  
X3HC31  
X3HC33  
X3HC34  
X3HC38  
X3HC40  
X3HC41  
X3HC45  
X3R1  
X3R29  
X3SC401  
X3SC404  
X3SC405  
X3SC406  
X3SC407  
X3SC409  
X3SC411  
X3SC412  
X3SC413  
X3SC414  
X4AC09  
X4AC20  
X4AC31  
X4AC42  
X4C301  
X4C302

\_Economic Optimization Program

05/15/01 16:49:39 PAGE 207  
GAMS 2.50A Windows NT/95/98

X4C303  
X4C306  
X4C307  
X4C308  
X4C309  
X4C310  
X4C311  
X4C312  
X4C315  
X4C317  
X4C318  
X4C319  
X4C320  
X4C321  
X4C322  
X4C323  
X4C324  
X4C325  
X4C326  
X4C328  
X4C329  
X4C401  
X4C402

X4C403  
X4C404  
X4C405  
X4C406  
X4C407  
X4C408  
X4C409  
X4C410  
X4C411  
X4C412  
X4C413  
X4C414  
X4C415  
X4C418  
X4C419  
X4C425  
X4C426  
X4C427  
X4C428  
X4C430  
X4C431  
X4C432  
X4HC01  
\_Economic Optimization Program

05/15/01 16:49:39 PAGE 208  
GAMS 2.50A Windows NT/95/98

X4HC02  
X4HC03  
X4HC04  
X4HC05  
X4HC06  
X4HC07  
X4HC08  
X4HC11  
X4HC14  
X4HC15  
X4HC16  
X4HC22  
X4HC23  
X4HC24  
X4HC25  
X4HC26  
X4HC27  
X4HC28  
X4HC29  
X4HC30  
X4HC31  
X4HC33  
X4HC34  
X4HC38  
X4HC40  
X4HC41  
X4HC45  
X4R1  
X4R29  
X4SC401  
X4SC404  
X4SC405  
X4SC406  
X4SC407  
X4SC409  
X4SC411  
X4SC412  
X4SC413  
X4SC414  
X5AC09  
X5AC20  
X5AC31  
X5AC42  
X5C301  
X5C302  
X5C303  
\_Economic Optimization Program

05/15/01 16:49:39 PAGE 209  
GAMS 2.50A Windows NT/95/98

X5C306  
X5C307  
X5C308  
X5C309  
X5C310  
X5C311  
X5C312  
X5C315  
X5C317  
X5C318  
X5C319  
X5C320  
X5C321  
X5C322  
X5C323

X5C324  
X5C325  
X5C326  
X5C328  
X5C329  
X5C401  
X5C402  
X5C403  
X5C404  
X5C405  
X5C406  
X5C407  
X5C408  
X5C409  
X5C410  
X5C411  
X5C412  
X5C413  
X5C414  
X5C415  
X5C418  
X5C419  
X5C425  
X5C426  
X5C427  
X5C428  
X5C430  
X5C431  
X5C432  
X5HC01  
X5HC02

\_Economic Optimization Program

05/15/01 16:49:39 PAGE 210  
GAMS 2.50A Windows NT/95/98

X5HC03  
X5HC04  
X5HC05  
X5HC06  
X5HC07  
X5HC08  
X5HC11  
X5HC14  
X5HC15  
X5HC16  
X5HC22  
X5HC23  
X5HC24  
X5HC25  
X5HC26  
X5HC27  
X5HC28  
X5HC29  
X5HC30  
X5HC31  
X5HC33  
X5HC34  
X5HC38  
X5HC40  
X5HC41  
X5HC45  
X5R1  
X5R29  
X5SC401  
X5SC404  
X5SC405  
X5SC406  
X5SC407  
X5SC409  
X5SC411  
X5SC412  
X5SC413  
X5SC414  
X6SC401  
X6SC404  
X6SC405  
X6SC406  
X6SC407  
X6SC409  
X6SC411  
X6SC412

\_Economic Optimization Program

05/15/01 16:49:39 PAGE 211  
GAMS 2.50A Windows NT/95/98

X6SC413  
X6SC414  
X7AC09  
X7AC20  
X7AC31  
X7AC42  
X7C301

X7C302  
X7C303  
X7C306  
X7C307  
X7C308  
X7C309  
X7C310  
X7C311  
X7C312  
X7C315  
X7C316  
X7C317  
X7C318  
X7C319  
X7C320  
X7C321  
X7C322  
X7C323  
X7C324  
X7C325  
X7C326  
X7C328  
X7C329  
X7C401  
X7C402  
X7C403  
X7C404  
X7C405  
X7C406  
X7C407  
X7C408  
X7C409  
X7C410  
X7C411  
X7C412  
X7C413  
X7C414  
X7C415  
X7C417  
\_Economic Optimization Program

05/15/01 16:49:39 PAGE 212  
GAMS 2.50A Windows NT/95/98

X7C418  
X7C419  
X7C425  
X7C426  
X7C427  
X7C428  
X7C430  
X7C431  
X7C432  
X7HC01  
X7HC02  
X7HC03  
X7HC04  
X7HC05  
X7HC06  
X7HC07  
X7HC08  
X7HC11  
X7HC14  
X7HC15  
X7HC16  
X7HC22  
X7HC23  
X7HC24  
X7HC25  
X7HC26  
X7HC27  
X7HC28  
X7HC29  
X7HC30  
X7HC31  
X7HC33  
X7HC34  
X7HC38  
X7HC40  
X7HC41  
X7HC45  
X7R1  
X7R29  
X7SC401  
X7SC404  
X7SC405  
X7SC406  
X7SC407  
X7SC409  
X7SC411  
\_Economic Optimization Program

05/15/01 16:49:39 PAGE 213  
GAMS 2.50A Windows NT/95/98



X7SC412  
X7SC413  
X7SC414  
X8AC09  
X8AC20  
X8AC31  
X8AC42  
X9AC09  
X9AC20  
X9AC31  
X9AC42  
XAC02  
XAC05  
XAC07  
XAC09  
XAC12  
XAC15  
XAC18  
XAC20  
XAC23  
XAC26  
XAC29  
XAC31  
XAC34  
XAC37  
XAC40  
XAC42  
XIC10AC09  
XIC10AC20  
XIC10AC31  
XIC10AC42  
XIC11AC09  
XIC11AC20  
XIC11AC31  
XIC11AC42  
XM1C606D  
XM3C606D  
XM4C606D  
XM5C606D  
XM7C606D  
XX1C302  
XX1C308  
XX1C310  
XX1C311  
XX1C312  
XX1C323

Economic Optimization Program

05/15/01 16:49:39 PAGE 214  
GAMS 2.50A Windows NT/95/98

XX1C325  
XX1C405  
XX1C408  
XX1C425  
XX1C428  
XX1C430  
XX1C431  
XX1HC28  
XX1HC29  
XX1HC30  
XX1HC32  
XX1R1  
XX1R29  
XX1SC406  
XX1SC408  
XX2HC28  
XX2HC29  
XX2HC30  
XX2R1  
XX2R29  
XX2SC406  
XX2SC408  
XX3C302  
XX3C308  
XX3C310  
XX3C311  
XX3C312  
XX3C323  
XX3C325  
XX3C405  
XX3C408  
XX3C425  
XX3C428  
XX3C430  
XX3C431  
XX3C432  
XX3HC28  
XX3HC29  
XX3HC30  
XX3HC32  
XX3R1

XX3R29  
XX3SC406  
XX3SC408  
XX4C302  
XX4C308  
\_Economic Optimization Program

05/15/01 16:49:39 PAGE 215  
GAMS 2.50A Windows NT/95/98

XX4C310  
XX4C311  
XX4C312  
XX4C323  
XX4C325  
XX4C405  
XX4C408  
XX4C409  
XX4C425  
XX4C427  
XX4C428  
XX4C430  
XX4C431  
XX4C432  
XX4HC28  
XX4HC29  
XX4HC30  
XX4HC32  
XX4R1  
XX4R29  
XX4SC406  
XX4SC408  
XX5C302  
XX5C308  
XX5C310  
XX5C311  
XX5C312  
XX5C323  
XX5C325  
XX5C405  
XX5C408  
XX5C425  
XX5C428  
XX5C430  
XX5C431  
XX5HC28  
XX5HC29  
XX5HC30  
XX5HC32  
XX5R1  
XX5R29  
XX5SC406  
XX5SC408  
XX6SC406  
XX6SC408  
XX7C302  
\_Economic Optimization Program

05/15/01 16:49:39 PAGE 216  
GAMS 2.50A Windows NT/95/98

XX7C308  
XX7C310  
XX7C311  
XX7C312  
XX7C323  
XX7C325  
XX7C405  
XX7C408  
XX7C425  
XX7C428  
XX7C430  
XX7C431  
XX7HC28  
XX7HC29  
XX7HC30  
XX7HC32  
XX7R1  
XX7R29  
XX7SC406  
XX7SC408  
Y1HC28  
Y1HC29  
Y1HC30  
Y1HC31  
Y1R1  
Y1R29  
Y2HC28  
Y2HC29  
Y2HC30  
Y2HC31  
Y2R1  
Y2R29  
Y3HC28

Y3HC29  
Y3HC30  
Y3HC31  
Y3R1  
Y3R29  
Y4HC28  
Y4HC29  
Y4HC30  
Y4HC31  
Y4R1  
Y4R29  
Y5HC28  
Y5HC29  
\_Economic Optimization Program

05/15/01 16:49:39 PAGE 217  
GAMS 2.50A Windows NT/95/98

Y5HC30  
Y5HC31  
Y5R1  
Y5R29  
Y7HC28  
Y7HC29  
Y7HC30  
Y7HC31  
Y7R1  
Y7R29  
YY1HC28  
YY1HC29  
YY1HC30  
YY1R1  
YY1R29  
YY2HC28  
YY2HC29  
YY2HC30  
YY2R1  
YY2R29  
YY3HC28  
YY3HC29  
YY3HC30  
YY3R1  
YY3R29  
YY4HC28  
YY4HC29  
YY4HC30  
YY4R1  
YY4R29  
YY5HC28  
YY5HC29  
YY5HC30  
YY5R1  
YY5R29  
YY7HC28  
YY7HC29  
YY7HC30  
YY7R1  
YY7R29

\*\*\*\* REPORT SUMMARY : 0 NONOPT  
0 INFEASIBLE  
0 UNBOUNDED  
0 ERRORS  
\_Economic Optimization Program

05/15/01 16:49:39 PAGE 218  
GAMS 2.50A Windows NT/95/98

EXECUTION TIME = 0.170 SECONDS 1.3 Mb WIN-18-097

USER: Ralph W. Pike G990726:1450AP-WIN  
Louisiana State University, Department of Chemical Engineering DC267

\*\*\*\* FILE SUMMARY

INPUT C:\PROGRAM FILES\GAMSIDE\DO\_ECON  
OUTPUT C:\PROGRAM FILES\GAMSIDE\DO\_ECON.LST  
SAVE C:\PROGRAM FILES\GAMSIDE\PUT\_DATA.G0?