

Demystifying Distributed Energy Resources and Microgrids

Implications for Louisiana

Jennifer Vosburg
Regional Senior Executive – South Central
SVP, NRG Energy, Inc.

October 21, 2015 LSU Center for Energy Studies



Implications for Louisiana



Hurricane Gustav knocked 241 transmission lines out of service along with 354 substations. In addition, 13 of the 14 transmission lines serving the New Orleans metropolitan area were out of service due to the storm, creating a situation where the New Orleans metropolitan area and a corridor along the Mississippi River between New Orleans and Baton Rouge essentially became an island, no longer electrically connected to the rest of the Entergy system and the electricity grid for the eastern United States. *Entergy Press Release: September 19, 2008*





Increased Awareness



Solar storm races toward Earth

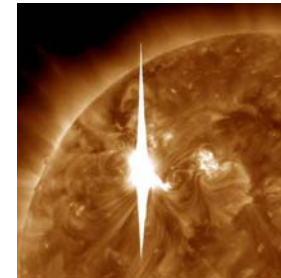

This handout image provided by NASA shows a solar flare heading toward Earth. An impressive solar flare is heading toward Earth and could disrupt power grids, GPS and airplane flights. An impressive solar flare is heading toward Earth and could disrupt power grids, GPS and airplane flights. Forecasters at the National Oceanic and Atmospheric Administration's (NOAA) Space Weather Prediction Center said the sun erupted Tuesday evening and the effects should start smacking Earth late Wednesday night, close to midnight EST. They say it is the biggest in five years and growing. (AP Photo/NASA)

The Advocate, March 7, 2012



Economic Impact of Grid Outages

POWER OUTAGE CAUSES



Trees



Lightning



Snow
and ice



Wind



Flooding



Accidents



Animals

Inflation-adjusted cost of weather-related outages to U.S. economy estimated at \$25-\$70 billion annually*

* Congressional Research Service, Weather-related Power Outages and Electric System Resiliency, Richard J. Campbell, Aug, 2012

Disruption of workflow due to loss of power can result in:

- Employee safety issues
- Loss of revenue
- Loss of productivity
- Inventory spoilage
- Machine downtime
- Computer network downtime
- Damage to grid infrastructure



Microgrid

A microgrid is a discrete energy system consisting of Distributed Energy Resources (DERs) and loads that can operate independently or in parallel with the traditional power grid.



Distributed Energy Resource (DER)

- Power that is generated locally or on site.
- It can be from a renewable fuel source but not always.
- It is not a new concept

Examples:

- Cogeneration
- Emergency or standby generations
 - diesel or natural gas fired.
- Solar
- Wind
- Vehicle to Grid
- Fuel Cells
- Energy Storage
- Demand Response



Off-grid Options

Fully disconnected from the grid

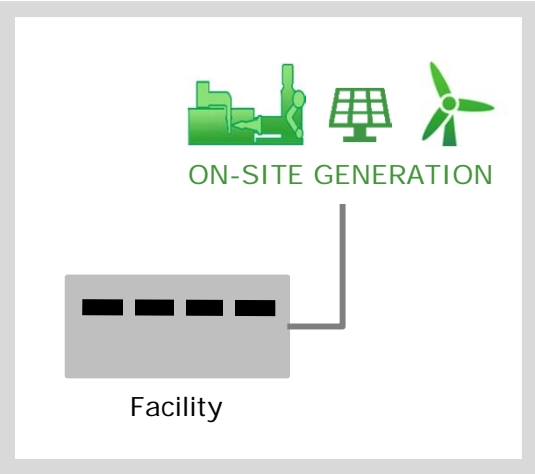

ALL ENERGY IS GENERATED ON SITE

All energy used by a facility is generated on the site

If there is a failure in the production, the facility is without power

Remain connected to the grid

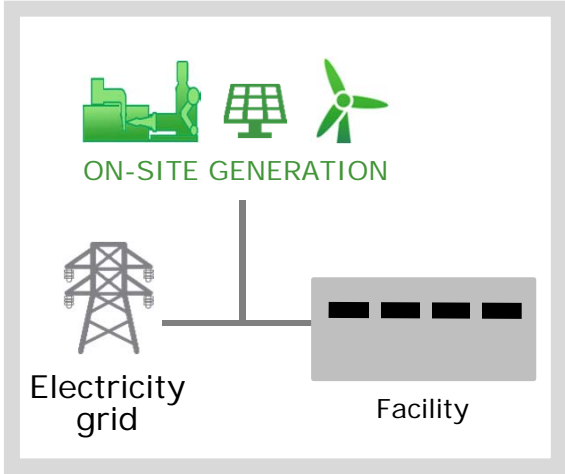

GRID AS BACKUP

Facility remains connected to the grid for back-up or supplemental energy

When grid goes down all power including on-site generated power is usually unavailable

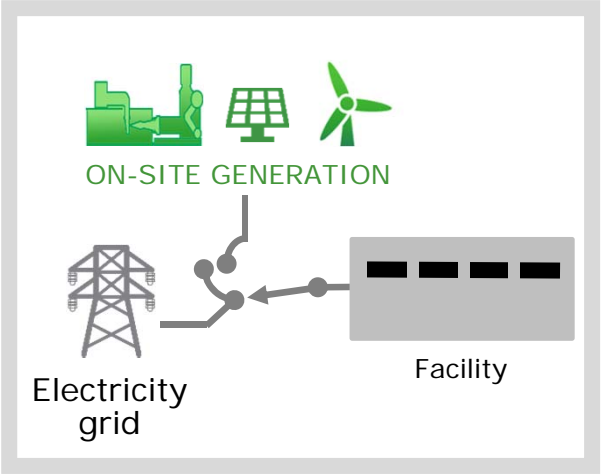

ABILITY TO "ISLAND" WITH GRID AS BACKUP

If the grid is not available, the facility is able to separate from the grid connection and, using its own production capacity, produce the energy to run the facility



Map of U.S. Operational Microgrid Deployments

124 microgrids* are currently in operation, with a total generation capacity of 1,169 MW

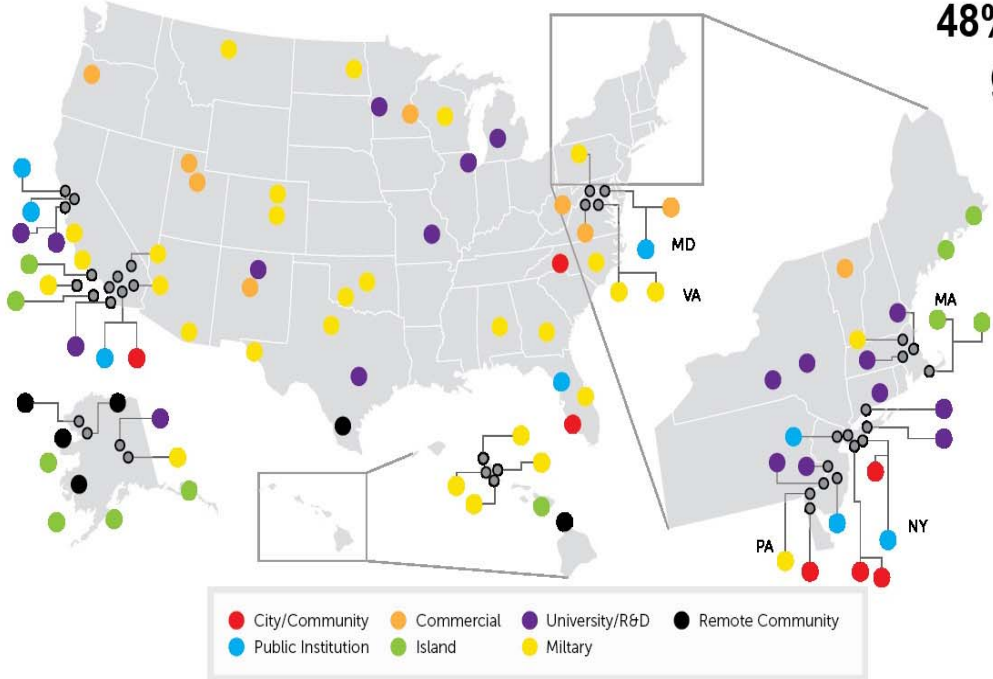

48% of operational microgrids are located in Northeast (29%) and West Coast (19%) states

Regional hotspots include California (23), Alaska (12), New York (10), and Hawaii (8).

Source: GTM Research North American Microgrids 2015



Military Focus on Microgrids

SPIDERS: Smart Power Infrastructure Demonstration for Energy Reliability and Security

Four Goals:

- To protect critical infrastructure from power loss in the event of physical or cyber disruptions to the bulk electric grid.
- To provide reliable backup power during emergencies by integrating renewables and other distributed generation sources into the microgrid.
- To ensure that critical operations can be sustained during prolonged utility power outages.
- To manage electrical power and consumption at military installations more efficiently, thus reducing petroleum demand, carbon emissions, and transportation costs.

• http://energy.sandia.gov/wp-content/gallery/uploads/SPIDERS_Fact_Sheet_2012-1431P.pdf



Medical Focus on Microgrids

Princeton Hospital



Princeton Hospital, NJ served by NRG Energy Center Princeton

CHP – Powered by a 4.6 MW combined heat and power (CHP) plant supplying 100% of heating and cooling needs

Thermal Energy – The recovered thermal energy is used to heat and cool the medical center and the steam is also used for sterilization

Solar – Panels over the parking lot produce 300 kW of solar energy

Grid power – And the ability to draw power from the PJM power grid is available if needed

Electric Vehicle Charging – Two eVgo charging stations

NRG Thermal was responsible for the design, construction and start-up; and continues to provide on-going operations services



NPU, CMEEC complete microgrid project at Backus Hospital

NORWICH, September 22, 2014 – Norwich Public Utilities (NPU) and the Connecticut Municipal Electric Energy Cooperative (CMEEC) announce the completion of a \$9 million microgrid generation project that will bring additional backup power capabilities to the Backus Hospital and provide electricity to a number of critical facilities adjacent to the site in the event of a large-scale power outage.

The microgrid project includes four 2.5 megawatt electric generators, which are located near the Backus Hospital employee parking lot (just off of Matlack Road) behind the hospital campus. The generators are tied into the hospital and its campus through an interconnection with both an underground cable and hardened overhead wire to insure the reliability of the emergency backup power.

Additional critical facilities in the area, including schools, emergency shelters, fire station, supermarket / pharmacy, public water supply, gas station and shopping center could also be served by the new generators in the event of a sustained power outage. These customers would be fed from the new distribution switchgear connected to NPU's existing overhead infrastructure.



Complete micro-grid Solutions

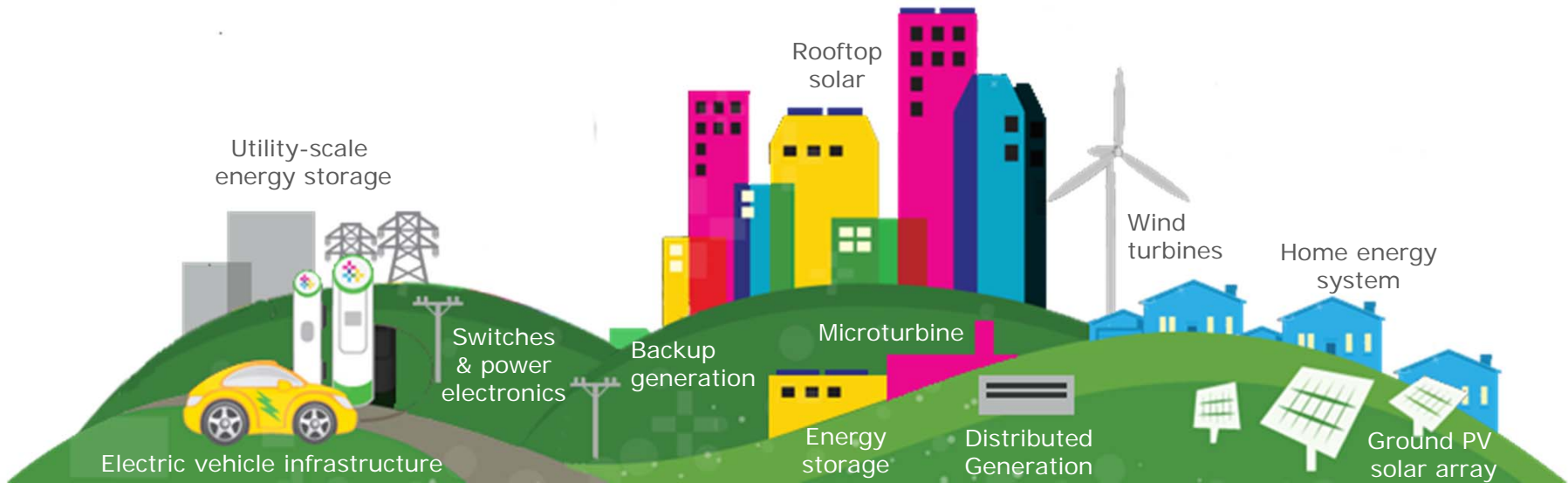

- Combined heat and power
- Renewable solutions
- Reliability solutions
- Energy efficiency measures
- Demand response programs
- Load reduction measures
- Distributed generation
- Energy management solutions



Distributed Energy Resources Management System (DERMS)

- Platform to integrate, manage and optimize distributed energy resources.
- Goal is to integrate with a traditional utility tools and markets
- Needed with higher penetration of DER.



Working Together

Conventional Grid

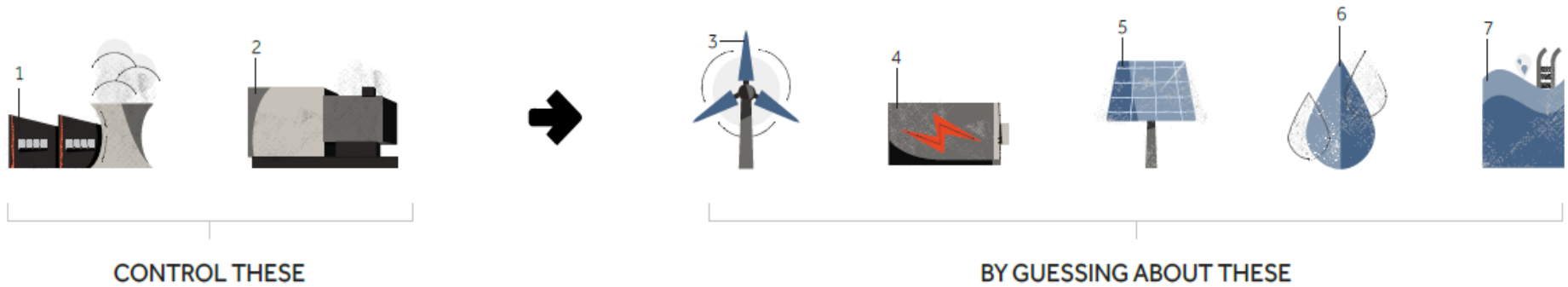

Microgrid

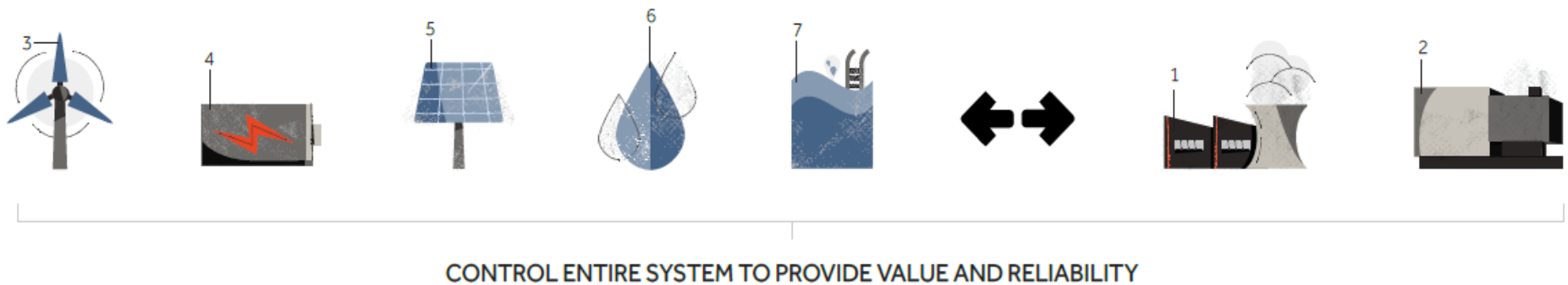

1—Power Plant 2—Diesel Back Up 3—Wind Turbines 4—Battery Storage 5—Solar Panel 6—Desalination Plants 7—Pool Heater



Questions?